

Hydro

UNICA





Hydro – A empresa de energia e alumínio

A Hydro é uma líder industrial que constrói negócios e parcerias para um futuro mais sustentável. Desenvolvemos indústrias que fazem a diferença para as pessoas e para a sociedade. Desde 1905, a Hydro transforma recursos naturais em produtos e negócios relevantes para as pessoas, criando um local de trabalho seguro e protegido para nossos 31.000 empregados*, em mais de 140 unidades, em 40 países. Hoje, possuímos e operamos vários negócios, além de investirmos em indústrias sustentáveis.

A Hydro, por meio de seus negócios, está presente em uma ampla gama de segmentos do mercado de alumínio, energia, reciclagem de metais, energias renováveis e baterias, oferecendo conhecimentos e competências únicas.

A Hydro está comprometida em liderar o setor na criação de um futuro mais sustentável, criando sociedades mais viáveis ao desenvolver recursos naturais em produtos e soluções de maneiras inovadoras e eficientes.

*Informação referente a data de fechamento do material.

Hydro Bauxita & Alumina

A Hydro Bauxita & Alumina inclui uma das maiores minas de bauxita do mundo e a maior refinaria de alumina fora da China, ambas no Brasil, representando dois elos importantes na cadeia de produção do nosso alumínio. Nossos mais de 4.000 empregados* trabalham nos escritórios do Brasil, na mina de Paragominas e na refinaria de alumina em Barcarena, no norte do país. Além disso, comercializamos alumina para clientes externos.

Hydro Energia

A Hydro Energia tem mais de 100 anos de experiência em energia hidrelétrica, sendo uma das três maiores operadoras de produção de energia na Noruega e empregando 200 pessoas*. Além disso, estamos envolvidos com energia eólica na Noruega e temos uma participação importante no mercado de energia na região nórdica e no Brasil.



Hydro Extrusão

A Hydro Extrusão é uma empresa líder mundial em extrusão de alumínio, com cerca de 100 unidades de produção, em 40 países, e empregando 20.000 pessoas. Por meio de uma combinação exclusiva de

experiência local, rede global e recursos de P&D incomparáveis, podemos oferecer desde perfis padronizados até desenvolvimento e fabricação avançados para a maioria das indústrias.



Portfólio Hydro

Para todos os tipos e padrões de obras.

Linhas
Comerciais

ECO 
FAÇADE

 CITTÀ

 UNIT

 ELEGANCE
MIRROR

Linhas
Residenciais

 SKYLINE

 INOVA

 UNICA

 GOLD Slim

 PRODUTIVA25

 MASTER

 NOVA
GOLD

Complementos
de Arquitetura

 ESPLENDOR

 UNIVERSAL
VARANDA E GRADIL

 MIRANTE

 UNIVERSAL
PORTÃO E GRADE



UNICA

Única

Voltada para o segmento residencial de altíssimo padrão, a Única é fruto da parceria com o renomado arquiteto Ruy Ohtake. Planejada para dar mais liberdade de criação, com ela é possível construir esquadrias nas mais variadas dimensões e configurações, sem abrir mão da sofistica-

ção e do design. O sistema apresenta um portfólio abrangente de tipologias e permite o uso de perfis bicolores, cores diferentes interna e externamente, assegurando mais versatilidade aos projetos de arquitetura.



Normas	B-01 B-04
Vantagens Única	C-01 C-04
Tipologias	D-01 D-03
Diagramas	E-01 E-36
Perfis	F-01 F-40
Componentes	G-01 G-44
Ferramentas de Usinagens	H-01 H-01
Usinagens	I-01 I-29
Detalhes Construtivos	J-01 J-13
Projetos de Montagem	K-01 K-39

NORMA ABNT NBR 10821-2017

A norma ABNT NBR 10821/17 estabelece os parâmetros mínimos de desempenho bde esquadrias localizadas na face externa das edificações de uso comercial ou residencial, em todo o Brasil. Esta norma abrange os seguintes pontos:

- Permeabilidade ao ar;
- Estanqueidade à água;
- Resistência às cargas uniformemente distribuídas (cargas de vento);
- Resistência às operações de manuseio

Quando falamos de resistência às cargas uniformemente distribuídas, esta norma nos traz um mapa de isopletras do Brasil, retirado da norma ABNT NBR 6123, em que encontramos a velocidade dos ventos, através da qual conseguimos calcular as forças devidas ao vento.

MAPA DE VELOCIDADE DO VENTO POR REGIÃO NO BRASIL

A velocidade do vento é o parâmetro inicial para calcularmos a pressão do vento no local desejado, além disso deve-se levar em conta, ainda, a altura do edifício, rugosidade do terreno, densidade de construções no entorno, topografia, forma geométrica do

edifício, entre outras características. Para facilitar, a NBR 10821/17 já traz a seguinte tabela, que determina as pressões de ensaio, de segurança e de água em edifícios de até 30 pavimentos ou 90 metros de altura para todas as regiões do Brasil.

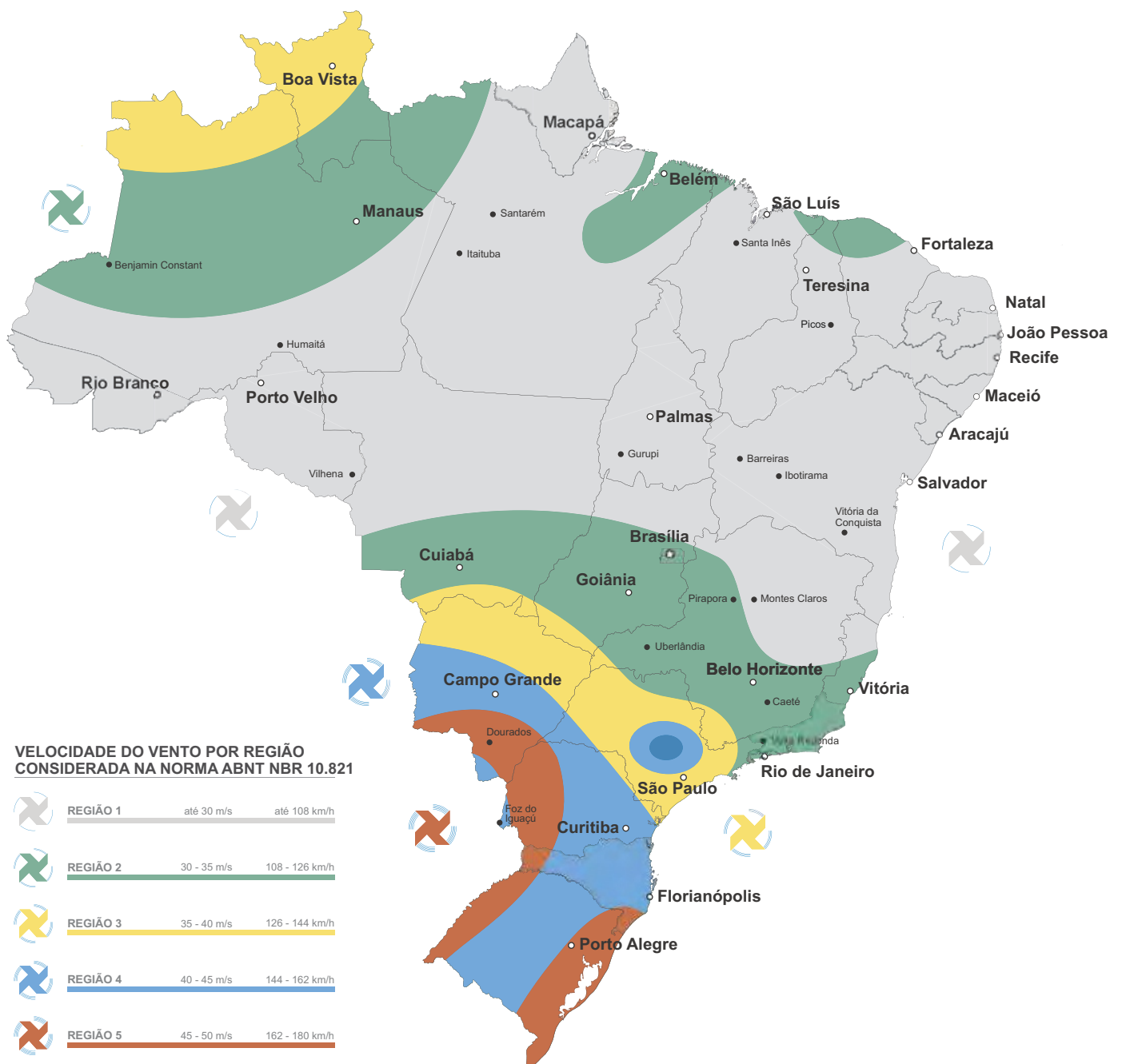

É importante destacar que esta tabela não é válida para:

- Edificações em que a esquadria não seja instalada na posição vertical;
- Edificações de formas não retangulares;
- Edificações com localização, especificação, necessidade e exigências especiais de utilização;
- Quando houver túnel de vento.

Para os três primeiros casos, as pressões devem ser calculadas de acordo com a norma NBR 6123 / 13. Caso seja encontrado um valor menor do que o que consta na tabela abaixo, deve-se prevalecer a maior pressão.

Valores de pressão do vento conforme a região do país e o número de pavimentos da edificação

Quantidade de pavimentos	Altura Máxima	Regiões do País	Pressão do ensaio Pe em (Pa) Positiva e negativa Pe = pp x 1,2	Pressão de segurança Ps em (Pa) Positiva e negativa Ps = pe x 1,5	Pressão de água Pa em (Pa) Positiva e negativa Pa = Pp x 0,2
02	6 m	I	350	520	60
		II	470	700	80
		III	610	920	100
		IV	770	1160	130
		V	950	1430	160
05	15 m	I	420	640	70
		II	580	860	100
		III	750	1130	130
		IV	950	1430	160
		V	1180	1780	200
10	30 m	I	500	750	80
		II	680	1030	110
		III	890	1340	150
		IV	1130	1700	190
		V	1400	2090	230
20	60 m	I	600	900	100
		II	815	1220	140
		III	1060	1600	180
		IV	1350	2020	220
		V	1660	2500	280
30	90 m	I	660	980	110
		II	890	1340	150
		III	1170	1750	200
		IV	1480	2210	250
		V	1820	2730	300

Começando da esquerda para a direita temos, na primeira coluna, a quantidade de pavimentos; na segunda, a altura máxima da edificação; na terceira, a região definida pelo mapa de isopletras (velocidades do vento); na quarta, a pressão de ensaio dada em Pascal; na quinta, a pressão de segurança dada em Pascal; e na sexta a pressão de água dada em Pascal.

Com a pressão de ensaio, o calculista começa a definir quais os perfis devem ser utilizados nas esquadrias tendo como base as exigências que constam na norma, que define: a flecha máxima dos perfis não pode ultrapassar $H/175$, sendo H a altura da esquadria, ou 30 mm, o que for menor, tanto para o caso de pressão positiva, quanto negativa. Quando é realizado o teste em laboratório, além de ser verificada a flecha máxima, também se analisa se, após a retirada da pressão, a esquadria continua funcionando normalmente.

Já com a pressão de segurança, verifica-se casos extremos que a esquadria deve suportar. Por conta disso, não são medidas as flechas dos perfis, mas, sim, se houve, ou não, o colapso total ou parcial de qualquer componente da esquadria,

inclusive o vidro. Se houver colapso de algum componente, a esquadria é reprovada.

Entende-se colapso como qualquer alteração vital no funcionamento do conjunto, sua estrutura ou componentes que coloque em risco os usuários ou terceiros.

Equipamentos

Os equipamentos fornecidos pela Hydro foram desenvolvidos por especialistas, gerando resultados impecáveis em termos dimensionais e de qualidade do corte. A aplicação desses equipamentos atende às recomendações técnicas da Hydro e a utilização de componentes originais.



Cálculo das dimensões máximas

Na definição das dimensões máximas de cada tipo de esquadria deverá ser considerado todos os aspectos construtivos do produto final, como características geométricas dos perfis utilizados, método de ligação da esquadria com a alvenaria, componentes especificados, espessura e tipo do vidro empregado e esforços a resistir.

Recomenda-se que esse cálculo seja feito por profissional habilitado, sempre levando em conta as normas pertinentes. Alguns gráficos com o desempenho estrutural de configurações comuns são mostrados neste catálogo. Eles foram desenvolvidos de acordo com as recomendações das Normas Brasileiras.

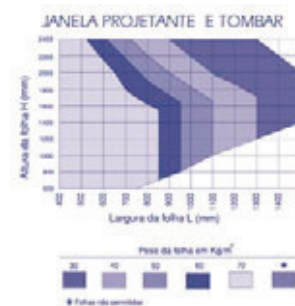

Thermal break

Um perfil para esquadrias com "Thermal break" é um conjunto solidário de dois extrudados de alumínio ligados longitudinalmente por um terceiro perfil de material de baixa condutividade térmica, permitindo que a face do perfil exposta à temperatura externa esteja isolada da face interna, impedindo a troca de calor por meio do conjunto, melhorando as condições de conforto e economizando energia necessária para aquecer ou resfriar o ambiente.

O sistema "Thermal break" utiliza ligação de poliamida reforçada, material utilizado nos melhores sistemas mundiais.



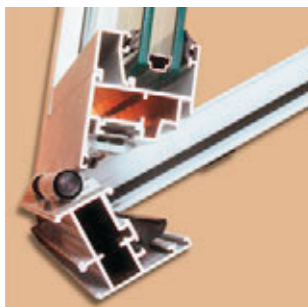

Perfis

Os extrudados de alumínio da Linha Única são produzidos na liga Hydro 6060-T5, adequada para receber os acabamentos de superfície, tais como anodização de vários tons ou pintura em várias cores. Pode ter também uma combinação diferente de acabamentos, tanto no lado interno ou externo.



Componentes

Os inúmeros componentes desenvolvidos especialmente para a Linha Única, como fechos perimetrais, roldanas, maçanetas, braços articulados, dobradiças e puxadores, constituem-se em um diferencial importantíssimo desse novo produto Hydro. Responsáveis pelo funcionamento impecável e pela longa vida, os componentes foram desenvolvidos e fabricados por empresas conceituadas internacionalmente, utilizando materiais e técnicas de última geração.



As esquadrias da Linha Única foram projetadas especialmente para seu funcionamento, vedação, durabilidade e aparência, características que dependem fundamentalmente de componentes adequados. Por isso os componentes são bem acabados, resistentes e oferecem todos os recursos necessários de posicionamento e regulação.



Envidraçamento

A especificação do tipo de vidro que será utilizado nas esquadrias da Linha Única deverá ser feita levando-se em conta a aplicação final, principalmente dimensões, pressões de vento a resistir e comportamentos térmicos e acústicos e a substituição dos vidros com a esquadria montada. Elas se apresentam em diferentes espessuras, garantindo a compressão necessária e o desempenho esperado.

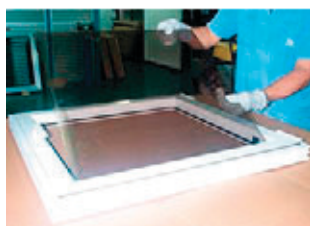



Tratamentos de superfície

Os tratamentos de superfície oferecidos pela Hydro - anodização fosca (natural ou colorida) e pinturas eletrostáticas em pó - atendem às exigências das Normas Brasileiras pertinentes e garantem longa vida útil às esquadrias em que são aplicados.

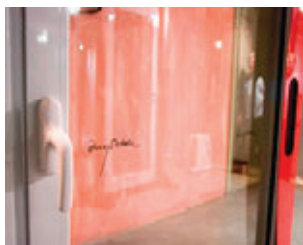

Design

Os perfis desenvolvidos pelo renomado Ruy Ohtake têm design incomparável, com linhas curvas que conferem modernidade e ergonomia ao conjunto. Isso se aplica aos acessórios exclusivos da linha, como as cremonas e puxadores, com encaixe perfeito para as mãos.



Bordas retas ou arredondadas

Os perfis que formam as folhas e os baguetes podem ter bordas retas ou arredondadas. Essas alternativas podem ajudar o arquiteto a especificar esquadrias que combinem melhor com o ambiente em que serão empregadas.

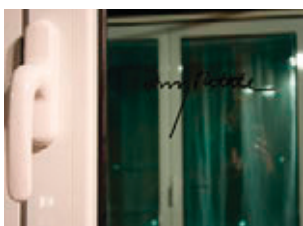

Componentes visíveis

Os componentes visíveis, como dobradiças, fechos e maçanetas foram desenvolvidos para complementar os conjuntos de maneira harmoniosa. Suas formas e acabamentos sempre propiciam aos especificadores várias alternativas, possibilitando um toque pessoal no projeto.

Possibilidade de dois acabamentos

O recurso "Thermal break", além de sua função básica de impedir troca térmica entre os ambientes interno e externo, propicia ao especificador a possibilidade de utilizar as esquadrias com o acabamento interno diferente do externo. Por exemplo: a esquadria pode ser branca por fora e prateada por dentro.



Vedação acústica

O comportamento acústico de uma esquadria de alumínio depende, fundamentalmente, de sua tipologia, de seus recursos de projeto quanto à vedação das frestas, de cuidados quanto à fabricação e instalação dos vidros empregados.

Janelas de abrir, tombar ou maxim-ares apresentam melhores desempenhos em vedação acústica se comparado às janelas de correr convencionais de qualidade equivalente - com folhas em planos diferentes.

O alojamento de vidros de 4 a 33 milímetros permite ao especificador definir o vidro adequado às suas exigências, seja vidro comum monolítico, duplo, laminado, temperado ou especial. Apresentando desempenho excepcional com relação à vedação ao ar e a água, graças à utilização dos conceitos mais modernos de projeto e ao desenvolvimento de componentes específicos, as esquadrias da Linha Única asseguram que o desempenho acústico do vidro não será influenciado pelos perfis e componentes.

Recomenda-se que a especificação dos vidros seja feita por profissionais habilitados, que levarão em conta o tipo de esquadria, os efeitos desejados e os vidros disponíveis.



Fixação na alvenaria

Em função das grandes dimensões possíveis e dos vários tipos e configurações de vidros que poderão ser utilizados, o peso total de uma esquadria da Linha Única pode atingir valores superiores aos quais estamos acostumados.

Essa constatação levou a Hydro ao inédito modo de ligação da esquadria com a alvenaria, que assegura a estabilidade dos conjuntos mais pesados e facilita o transporte e a colocação.

O sistema possibilita a instalação do conjunto de dentro para fora, privilegiando a segurança.

A fixação é feita com robustos parafusos de aço inoxidável, previamente alojados em canal apropriado no contramarco. Ajustes, regulagens e perfeita vedação são assegurados por detalhes exclusivos do conjunto.

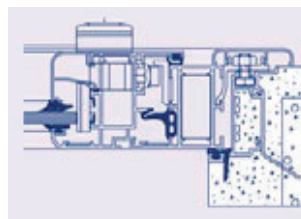

Janelas Oscilo Batente

com e sem Thermal Break, 1 e 2 folhas

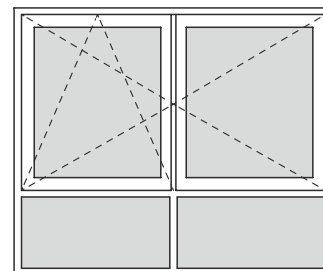
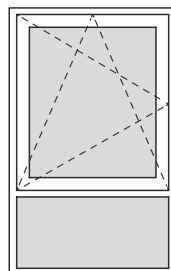
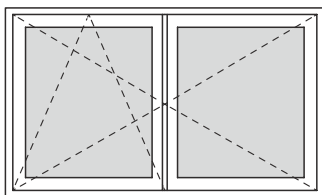
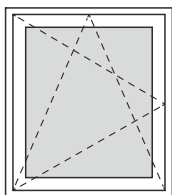

*O peitoril destas tipologias não tem a função de guarda-corpo

Janelas Oscilo Batente com persiana externa

sem Thermal Break 2 folhas

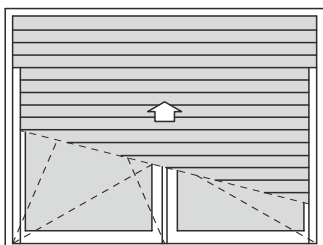

Janelas Oscilo Batente com veneziana orientável

com e sem Thermal Break 2 folhas

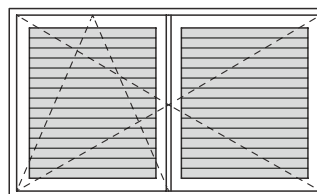

Janelas de Tombar

com e sem Thermal Break, 1 e 2 folhas

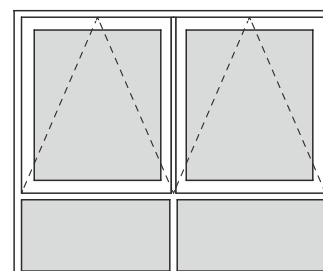
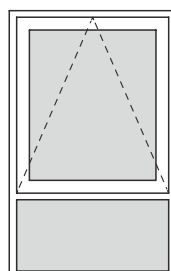
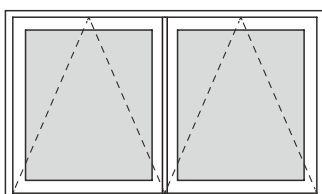
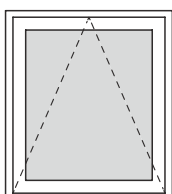

*O peitoril destas tipologias não tem a função de guarda-corpo

Janelas de Giro

com e sem Thermal Break, 1 e 2 folhas

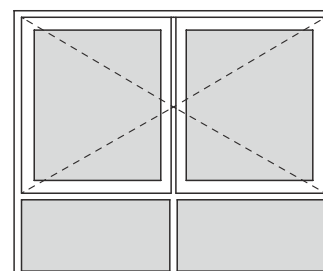
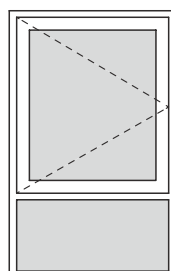
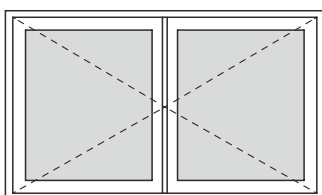
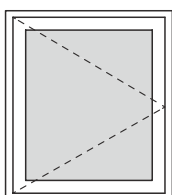

*O peitoril destas tipologias não tem a função de guarda-corpo

Janelas Maxim-ar

com e sem Thermal Break, 1 e 2 folhas

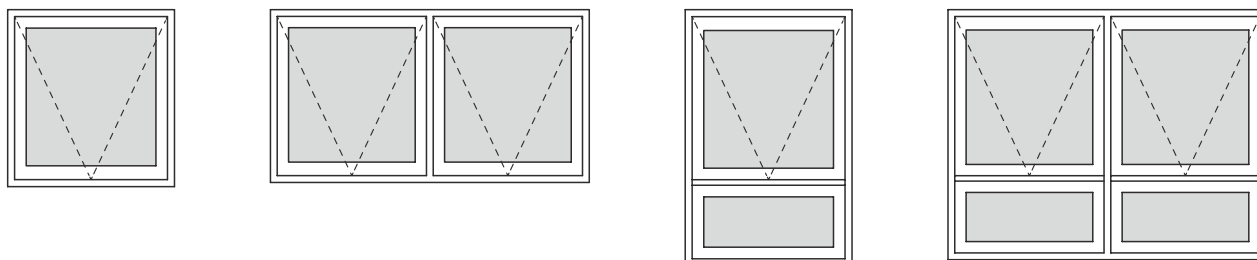

Janelas de Correr

com e sem Thermal Break, 2 e 4 folhas

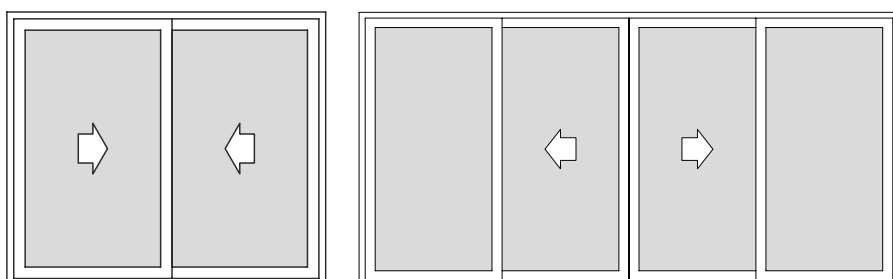

Janelas de Correr

com persiana externa
sem Thermal Break, 2 folhas

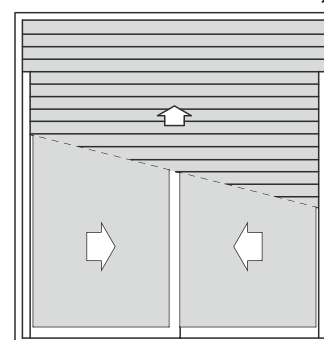

Portas de Correr

com e sem Thermal Break, 2 e 4 folhas

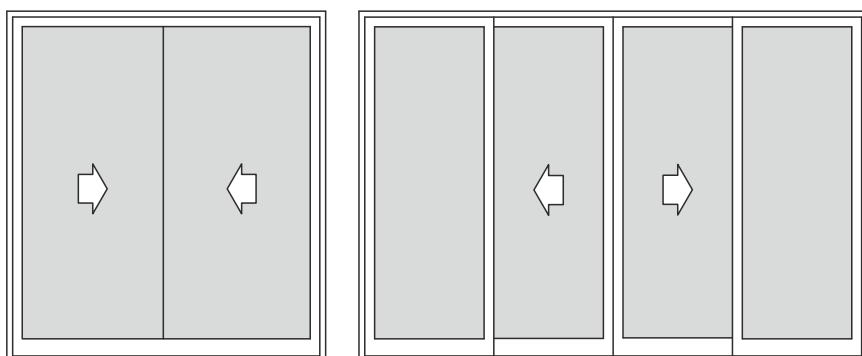

Porta de Correr

com persiana externa
sem Thermal Break, 2 folhas

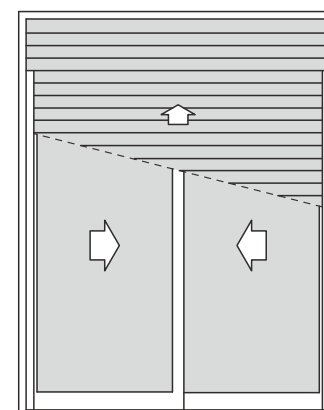

Janela e Porta de Correr

sem Thermal Break, 3 folhas

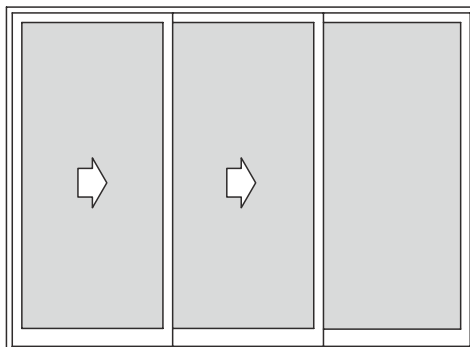

Portas de Correr Elevável

sem Thermal Break, 2 e 4 folhas

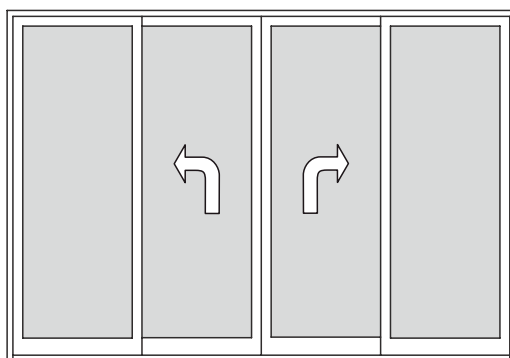
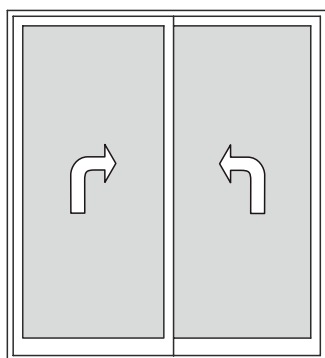

Porta de Correr Elevável com persiana externa

sem Thermal Break, 2 folhas

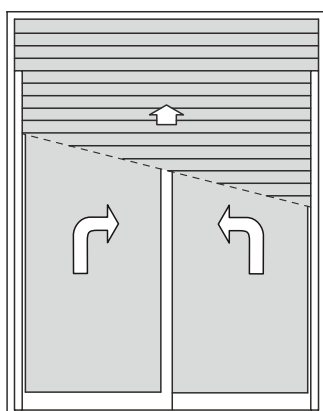

Portas de Giro

com e sem Thermal Break, 1 e 2 folhas

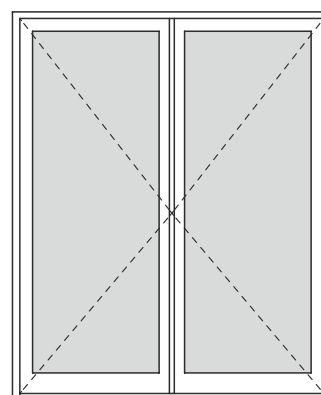
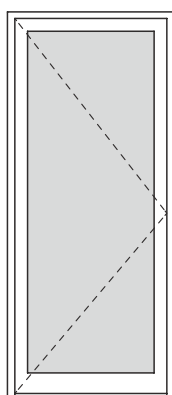

Diagramas de Dimensões

Janela e porta de correr - 2, 3 e 4 planos

Notas:

A largura do gráfico refere-se a apenas uma folha, ou seja, para obter a largura total da esquadria deve-se multiplicar a medida máxima encontrada no gráfico pela quantidade de folhas da tipologia.

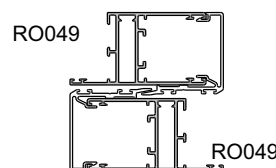
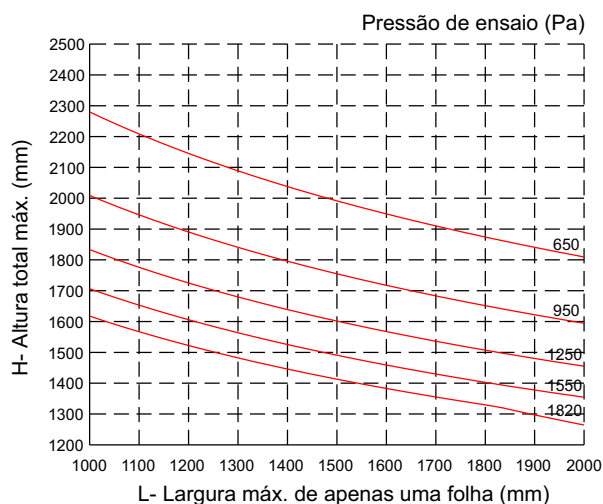
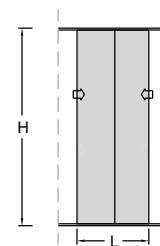

RO049	RO049
Área = 425 mm ²	Área = 425 mm ²
Jx = 125346 mm ⁴	Jx = 125346 mm ⁴
Wx = 5454 mm ³	Wx = 5454 mm ³
Jx total = 250692 mm⁴	

Tensão admissível = 7 kg/mm² (liga 6060-T5)

Flecha admissível = H / 175

Janela e porta de correr - 2, 3 e 4 planos

Notas:

A largura do gráfico refere-se a apenas uma folha, ou seja, para obter a largura total da esquadria deve-se multiplicar a medida máxima encontrada no gráfico pela quantidade de folhas da tipologia.

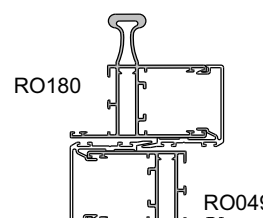
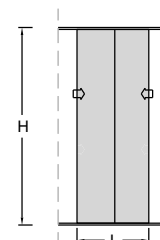
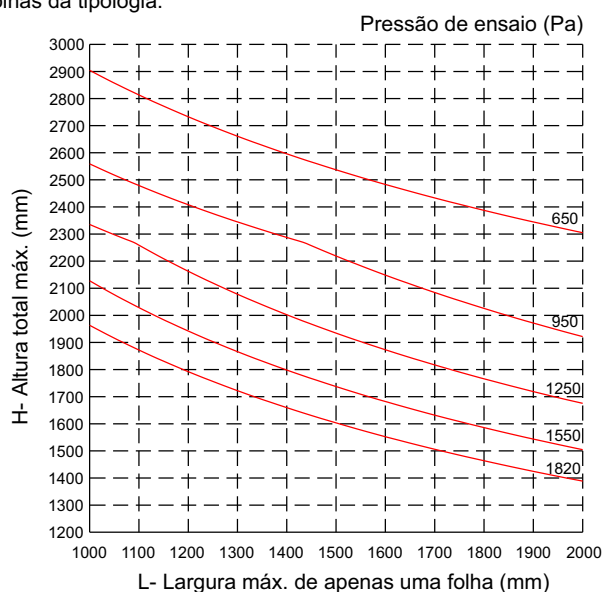

RO049	RO180
Área = 425 mm ²	Área = 618 mm ²
Jx = 125346 mm ⁴	Jx = 392911 mm ⁴
Wx = 5454 mm ³	Wx = 9974 mm ³
Jx total = 518257 mm⁴	

Tensão admissível = 7 kg/mm² (liga 6060-T5)

Flecha admissível = H / 175

Janela e porta de correr - 2, 3 e 4 planos

Notas:

A largura do gráfico refere-se a apenas uma folha, ou seja, para obter a largura total da esquadria deve-se multiplicar a medida máxima encontrada no gráfico pela quantidade de folhas da tipologia.

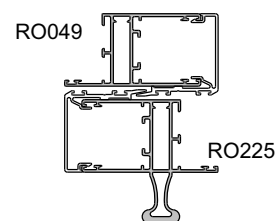
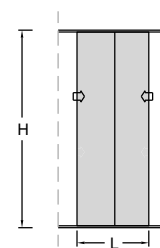
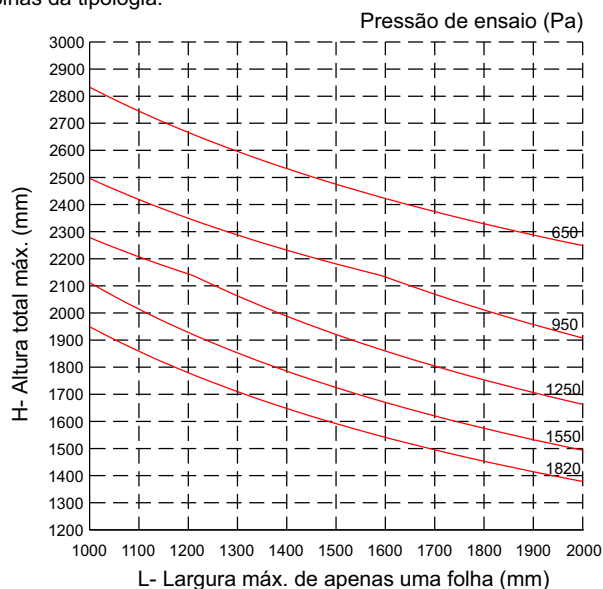

RO049	RO225
Área = 425 mm ²	Área = 618 mm ²
Jx = 125346 mm ⁴	Jx = 355914 mm ⁴
Wx = 5454 mm ³	Wx = 9590 mm ³
Jx total = 481260 mm⁴	

Tensão admissível = 7 kg/mm² (liga 6060-T5)

Flecha admissível = H / 175

Janela e porta de correr - 2, 3 e 4 planos

Notas:

A largura do gráfico refere-se a apenas uma folha, ou seja, para obter a largura total da esquadria deve-se multiplicar a medida máxima encontrada no gráfico pela quantidade de folhas da tipologia.

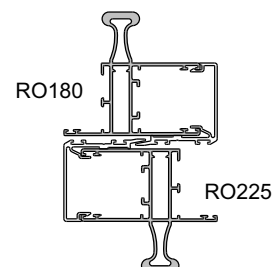
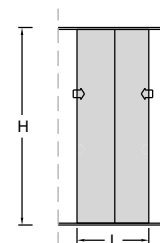
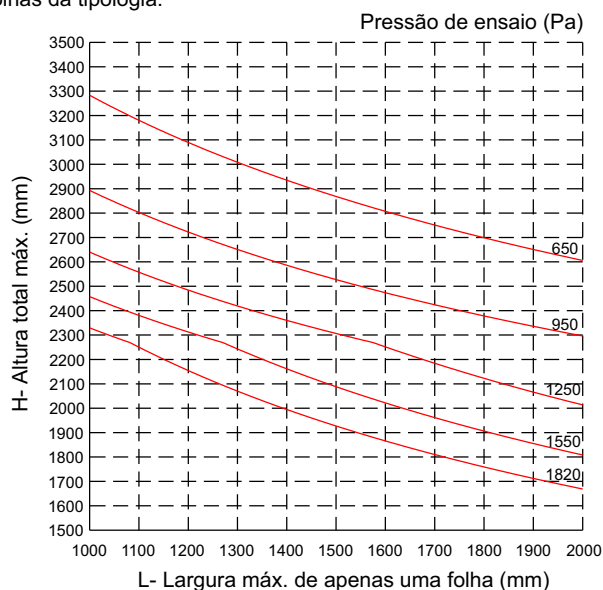

RO180	RO225
Área = 618 mm ²	Área = 618 mm ²
Jx = 392911 mm ⁴	Jx = 355914 mm ⁴
Wx = 9974 mm ³	Wx = 9590 mm ³
Jx total = 748825 mm⁴	

Tensão admissível = 7 kg/mm² (liga 6060-T5)

Flecha admissível = H / 175

Janela e porta de correr - 2, 3 e 4 planos

Notas:

A largura do gráfico refere-se a apenas uma folha, ou seja, para obter a largura total da esquadria deve-se multiplicar a medida máxima encontrada no gráfico pela quantidade de folhas da tipologia.

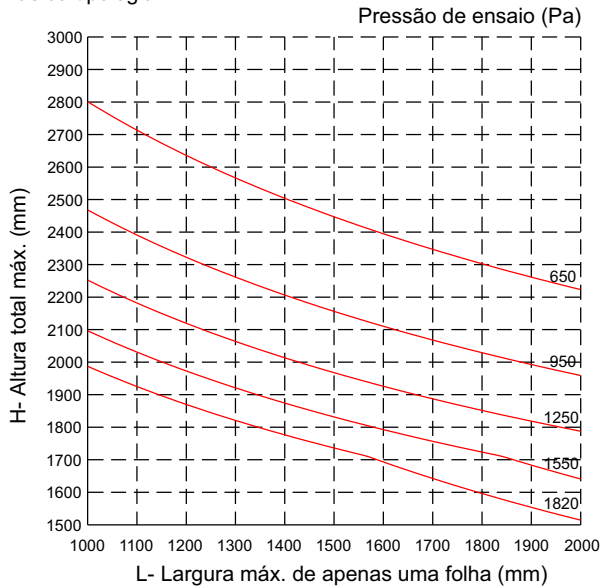

Tensão admissível = 7 kg/mm² (liga 6060-T5)

Flecha admissível = H / 175

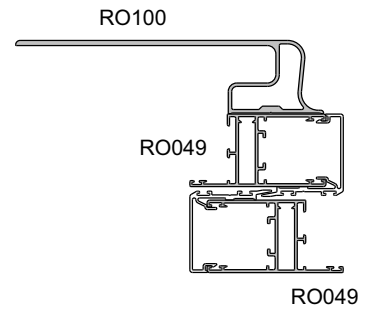
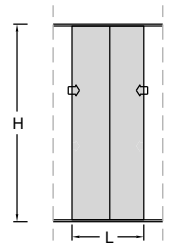

RO049	RO049	RO100
Área = 425 mm ²	Área = 425 mm ²	Área = 831 mm ²
Jx = 125346 mm ⁴	Jx = 125346 mm ⁴	Jx = 214344 mm ⁴
Wx = 5454 mm ³	Wx = 5454 mm ³	Wx = 10908 mm ³
Jx total = 465036 mm⁴		

Janela e porta de correr - 2, 3 e 4 planos

Notas:

A largura do gráfico refere-se a apenas uma folha, ou seja, para obter a largura total da esquadria deve-se multiplicar a medida máxima encontrada no gráfico pela quantidade de folhas da tipologia.

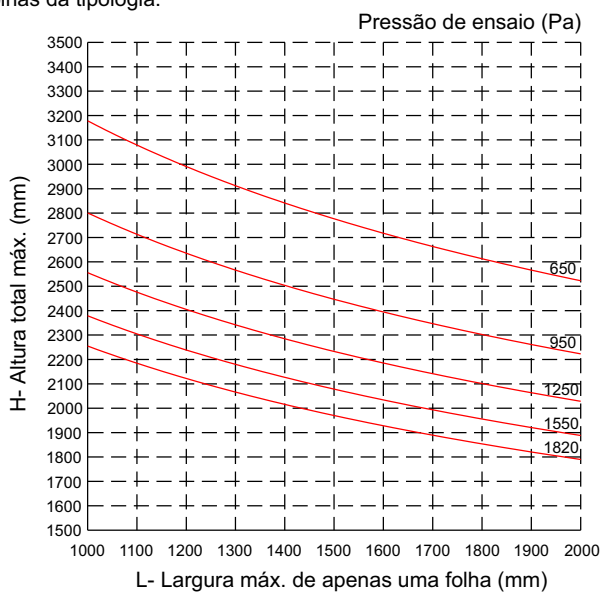

Tensão admissível = 7 kg/mm² (liga 6060-T5)

Flecha admissível = H / 175

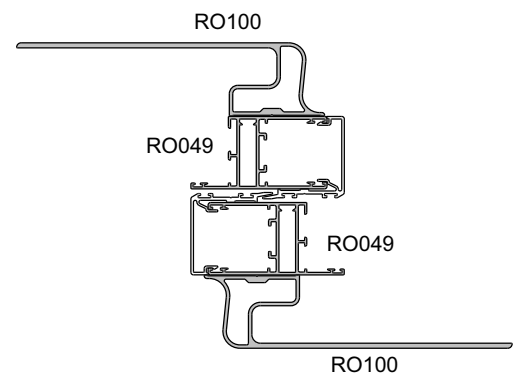
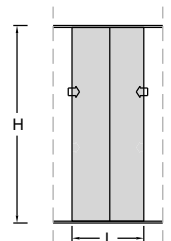

RO049	RO049	RO100	RO100
Área = 425 mm ²	Área = 425 mm ²	Área = 831 mm ²	Área = 831 mm ²
Jx = 125346 mm ⁴	Jx = 125346 mm ⁴	Jx = 214344 mm ⁴	Jx = 214344 mm ⁴
Wx = 5454 mm ³	Wx = 5454 mm ³	Wx = 10908 mm ³	Wx = 10908 mm ³
Jx total = 679380 mm⁴			

Janela e porta de correr - 2, 3 e 4 planos

Notas:

A largura do gráfico refere-se a apenas uma folha, ou seja, para obter a largura total da esquadria deve-se multiplicar a medida máxima encontrada no gráfico pela quantidade de folhas da tipologia.

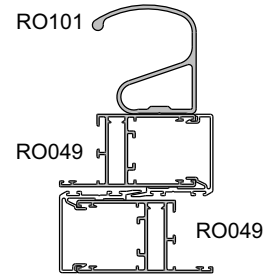
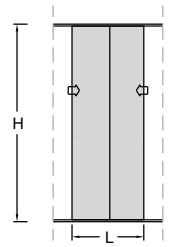
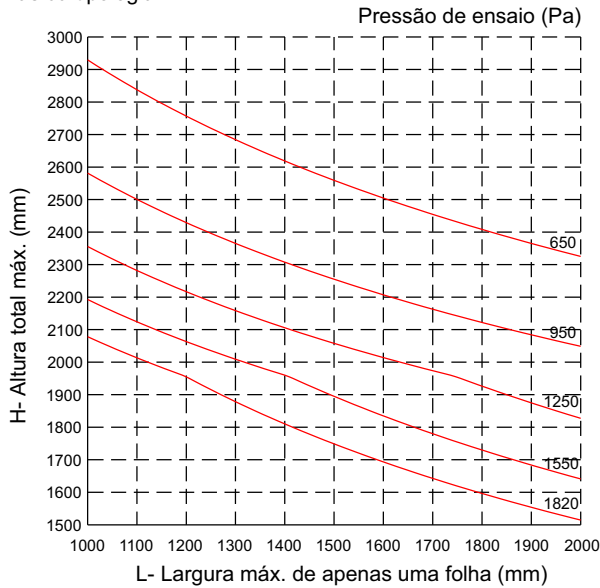

RO049	RO049	RO101
Área = 425 mm ²	Área = 425 mm ²	Área = 550 mm ²
Jx = 125346 mm ⁴	Jx = 125346 mm ⁴	Jx = 281259 mm ⁴
Wx = 5454 mm ³	Wx = 5454 mm ³	Wx = 8277 mm ³
Jx total = 531951 mm⁴		

Tensão admissível = 7 kg/mm² (liga 6060-T5)

Flecha admissível = H / 175

Janela e porta de correr - 2, 3 e 4 planos

Notas:

A largura do gráfico refere-se a apenas uma folha, ou seja, para obter a largura total da esquadria deve-se multiplicar a medida máxima encontrada no gráfico pela quantidade de folhas da tipologia.

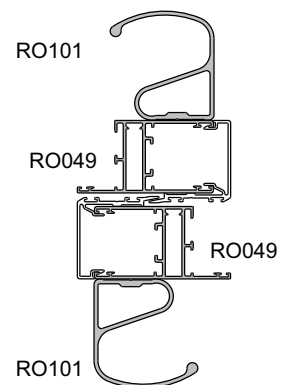
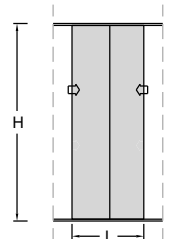
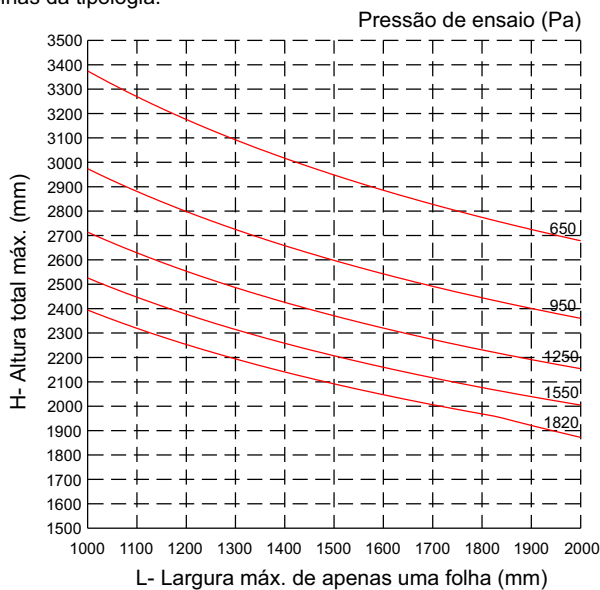

RO049	RO049	RO101	RO101
Área = 425 mm ²	Área = 425 mm ²	Área = 550 mm ²	Área = 550 mm ²
Jx = 125346 mm ⁴	Jx = 125346 mm ⁴	Jx = 281259 mm ⁴	Jx = 281259 mm ⁴
Wx = 5454 mm ³	Wx = 5454 mm ³	Wx = 8277 mm ³	Wx = 8277 mm ³
Jx total = 813210 mm⁴			

Tensão admissível = 7 kg/mm² (liga 6060-T5)

Flecha admissível = H / 175

Janela e porta de correr - 2, 3 e 4 planos

Notas:

A largura do gráfico refere-se a apenas uma folha, ou seja, para obter a largura total da esquadria deve-se multiplicar a medida máxima encontrada no gráfico pela quantidade de folhas da tipologia.

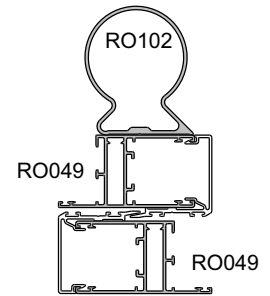
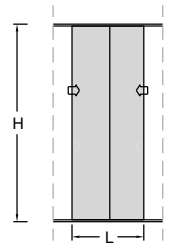
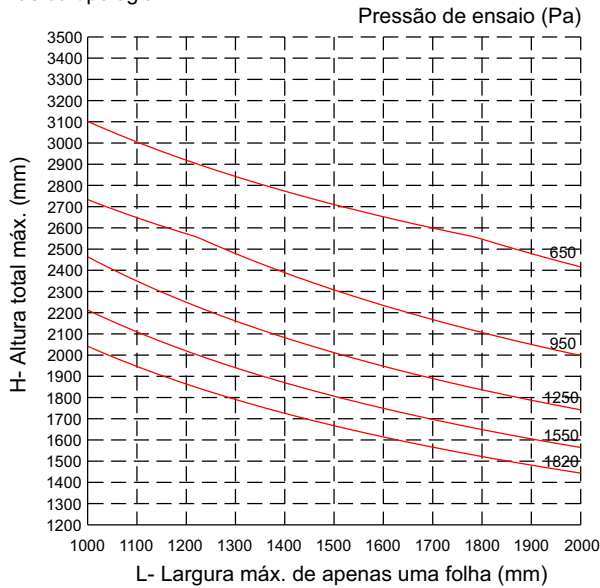

RO049	RO049	RO102
Área = 425 mm ²	Área = 425 mm ²	Área = 538 mm ²
Jx = 125346 mm ⁴	Jx = 125346 mm ⁴	Jx = 380871 mm ⁴
Wx = 5454 mm ³	Wx = 5454 mm ³	Wx = 8580 mm ³
Jx total = 631563 mm⁴		

Tensão admissível = 7 kg/mm² (liga 6060-T5)

Flecha admissível = H / 175

Janela e porta de correr - 2, 3 e 4 planos

Notas:

A largura do gráfico refere-se a apenas uma folha, ou seja, para obter a largura total da esquadria deve-se multiplicar a medida máxima encontrada no gráfico pela quantidade de folhas da tipologia.

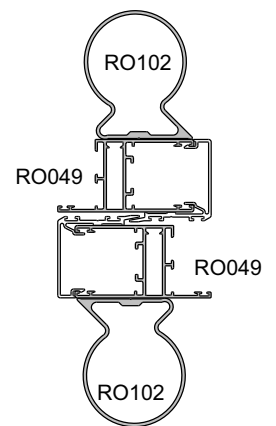
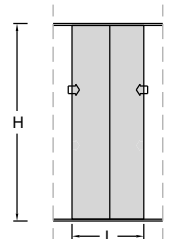
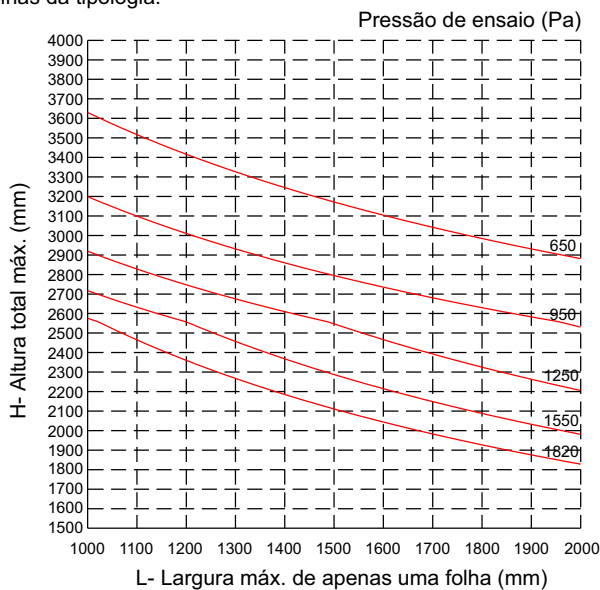

RO049	RO049	RO102	RO102
Área = 425 mm ²	Área = 425 mm ²	Área = 538 mm ²	Área = 538 mm ²
Jx = 125346 mm ⁴	Jx = 125346 mm ⁴	Jx = 380871 mm ⁴	Jx = 380871 mm ⁴
Wx = 5454 mm ³	Wx = 5454 mm ³	Wx = 8580 mm ³	Wx = 8580 mm ³
Jx total = 1012434 mm⁴			

Tensão admissível = 7 kg/mm² (liga 6060-T5)

Flecha admissível = H / 175

Janela e porta de correr - 2, 3 e 4 planos

Notas:

A largura do gráfico refere-se a apenas uma folha, ou seja, para obter a largura total da esquadria deve-se multiplicar a medida máxima encontrada no gráfico pela quantidade de folhas da tipologia.

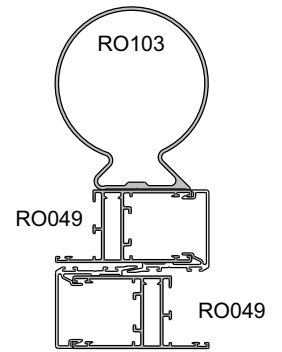
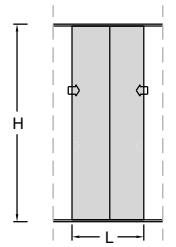
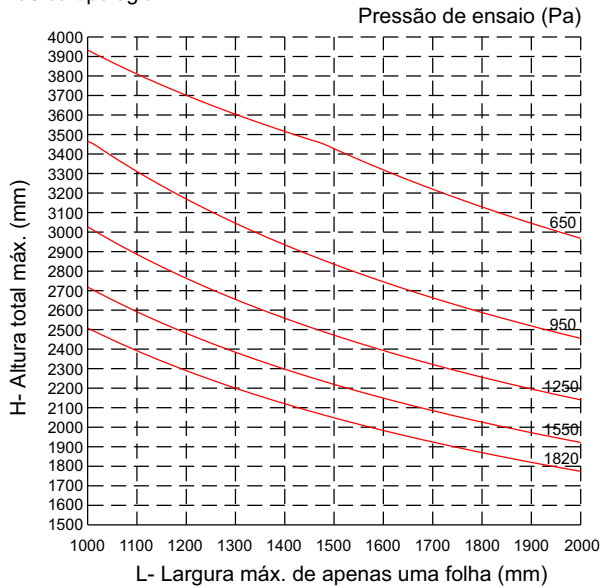

RO049	RO049	RO103
Área = 425 mm ²	Área = 425 mm ²	Área = 729 mm ²
Jx = 125346 mm ⁴	Jx = 125346 mm ⁴	Jx = 1036646 mm ⁴
Wx = 5454 mm ³	Wx = 5454 mm ³	Wx = 10908 mm ³
Jx total = 1287338 mm⁴		

Tensão admissível = 7 kg/mm² (liga 6060-T5)

Flecha admissível = H / 175

Janela e porta de correr - 2, 3 e 4 planos

Notas:

A largura do gráfico refere-se a apenas uma folha, ou seja, para obter a largura total da esquadria deve-se multiplicar a medida máxima encontrada no gráfico pela quantidade de folhas da tipologia.

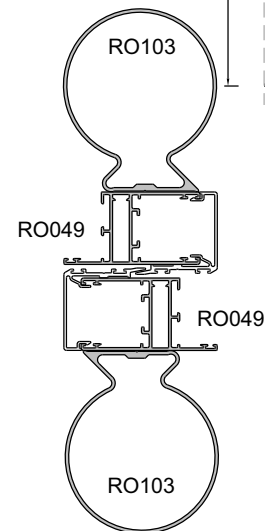
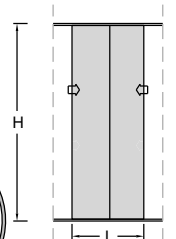
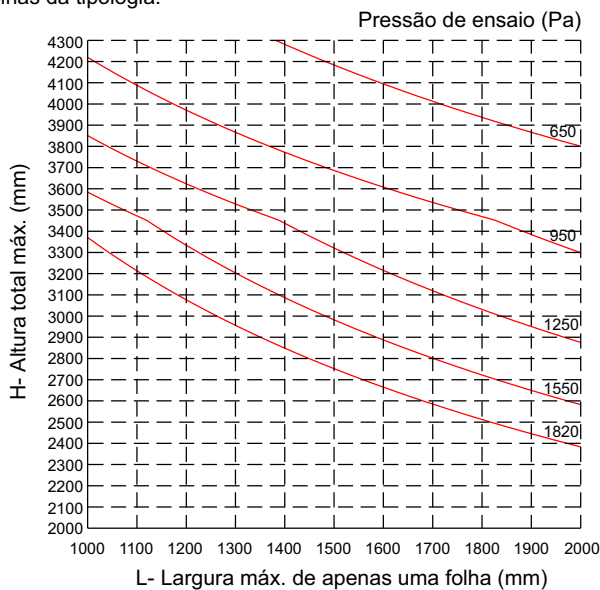

RO049	RO049	RO103	RO103
Área = 425 mm ²	Área = 425 mm ²	Área = 729 mm ²	Área = 729 mm ²
Jx = 125346 mm ⁴	Jx = 125346 mm ⁴	Jx = 1036646 mm ⁴	Jx = 1036646 mm ⁴
Wx = 5454 mm ³	Wx = 5454 mm ³	Wx = 10908 mm ³	Wx = 10908 mm ³
Jx total = 2323984 mm⁴			

Tensão admissível = 7 kg/mm² (liga 6060-T5)

Flecha admissível = H / 175

Janela e porta de correr - 2, 3 e 4 planos

Notas:

A largura do gráfico refere-se a apenas uma folha, ou seja, para obter a largura total da esquadria deve-se multiplicar a medida máxima encontrada no gráfico pela quantidade de folhas da tipologia.

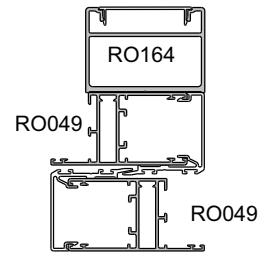
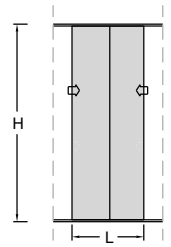
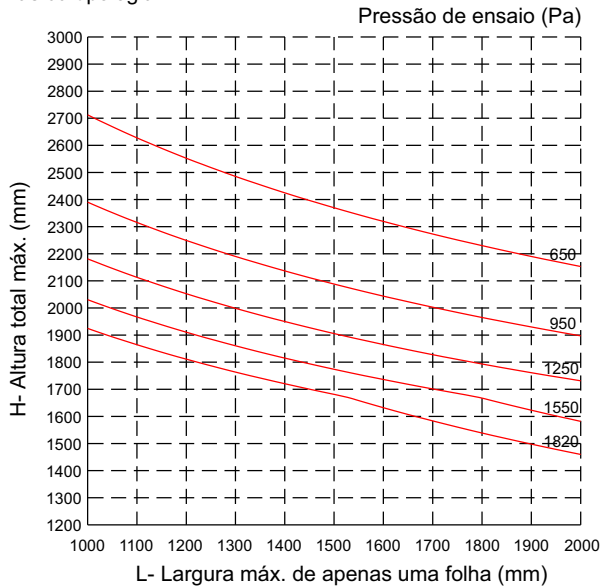

RO049	RO049	RO164
Área = 425 mm ²	Área = 425 mm ²	Área = 579 mm ²
Jx = 125346 mm ⁴	Jx = 125346 mm ⁴	Jx = 171680 mm ⁴
Wx = 5454 mm ³	Wx = 5454 mm ³	Wx = 5911 mm ³
Jx total = 422372 mm⁴		

Tensão admissível = 7 kg/mm² (liga 6060-T5)

Flecha admissível = H / 175

Janela e porta de correr - 2, 3 e 4 planos

Notas:

A largura do gráfico refere-se a apenas uma folha, ou seja, para obter a largura total da esquadria deve-se multiplicar a medida máxima encontrada no gráfico pela quantidade de folhas da tipologia.

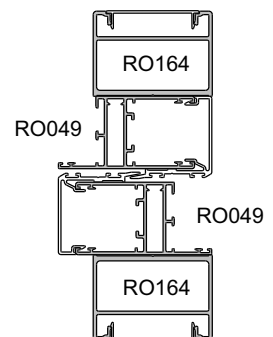
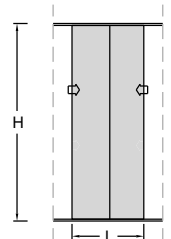
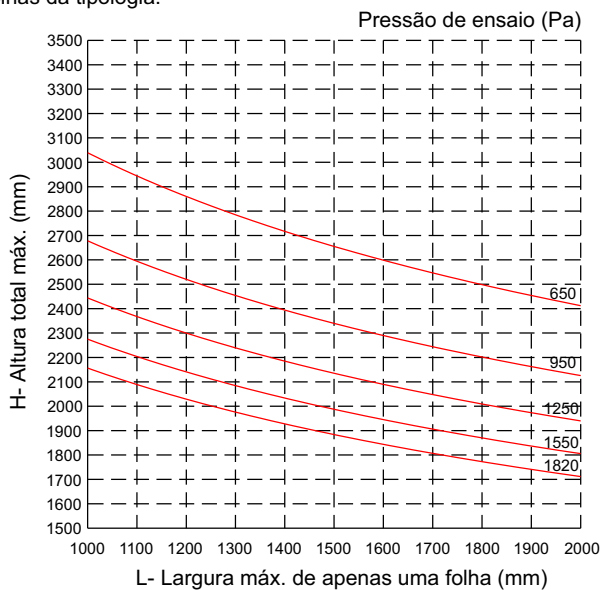

RO049	RO049	RO164	RO164
Área = 425 mm ²	Área = 425 mm ²	Área = 579 mm ²	Área = 579 mm ²
Jx = 125346 mm ⁴	Jx = 125346 mm ⁴	Jx = 171680 mm ⁴	Jx = 171680 mm ⁴
Wx = 5454 mm ³	Wx = 5454 mm ³	Wx = 5911 mm ³	Wx = 5911 mm ³
Jx total = 594052 mm⁴			

Tensão admissível = 7 kg/mm² (liga 6060-T5)

Flecha admissível = H / 175

Janela e porta de correr - 2, 3 e 4 planos

Notas:

A largura do gráfico refere-se a apenas uma folha, ou seja, para obter a largura total da esquadria deve-se multiplicar a medida máxima encontrada no gráfico pela quantidade de folhas da tipologia.

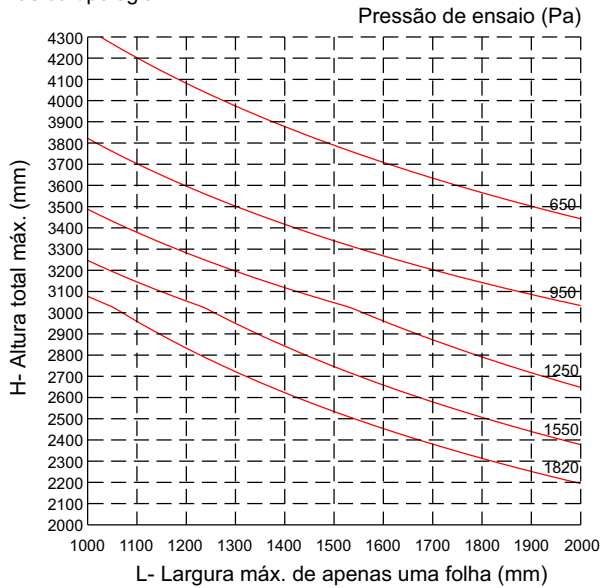

Tensão admissível = 7 kg/mm² (liga 6060-T5)

Flecha admissível = H / 175

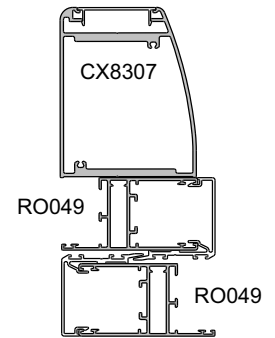
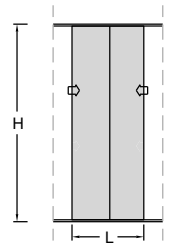

RO049	RO049	CX8307
Área = 425 mm ²	Área = 425 mm ²	Área = 1078 mm ²
Jx = 125346 mm ⁴	Jx = 125346 mm ⁴	Jx = 1476021 mm ⁴
Wx = 5454 mm ³	Wx = 5454 mm ³	Wx = 28098 mm ³
Jx total = 1726713 mm⁴		

Janela e porta de correr - 2, 3 e 4 planos

Notas:

A largura do gráfico refere-se a apenas uma folha, ou seja, para obter a largura total da esquadria deve-se multiplicar a medida máxima encontrada no gráfico pela quantidade de folhas da tipologia.

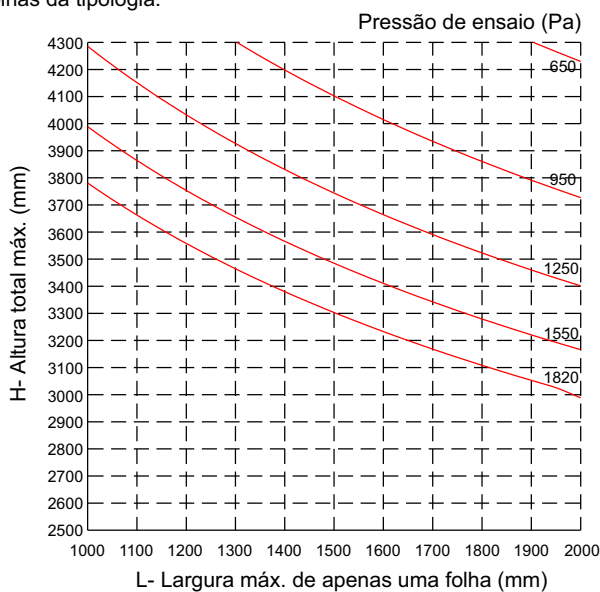

Tensão admissível = 7 kg/mm² (liga 6060-T5)

Flecha admissível = H / 175

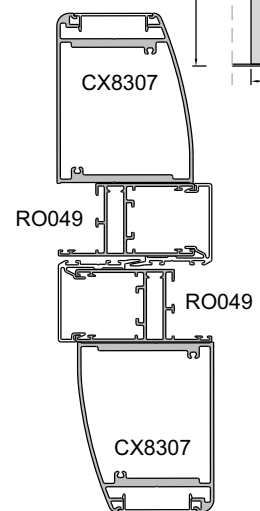
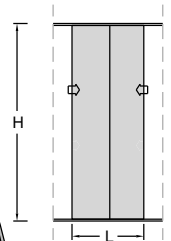

RO049	RO049	CX8307	CX8307
Área = 425 mm ²	Área = 425 mm ²	Área = 1078 mm ²	Área = 1078 mm ²
Jx = 125346 mm ⁴	Jx = 125346 mm ⁴	Jx = 1476021 mm ⁴	Jx = 1476021 mm ⁴
Wx = 5454 mm ³	Wx = 5454 mm ³	Wx = 28098 mm ³	Wx = 28098 mm ³
Jx total = 3202734 mm⁴			

Janela e porta de correr - 2 e 3 planos com encontro central

Notas:

A largura do gráfico refere-se a apenas uma folha, ou seja, para obter a largura total da esquadria deve-se multiplicar a medida máxima encontrada no gráfico pela quantidade de folhas da tipologia.

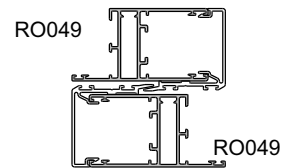
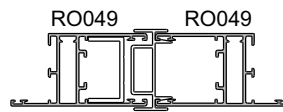
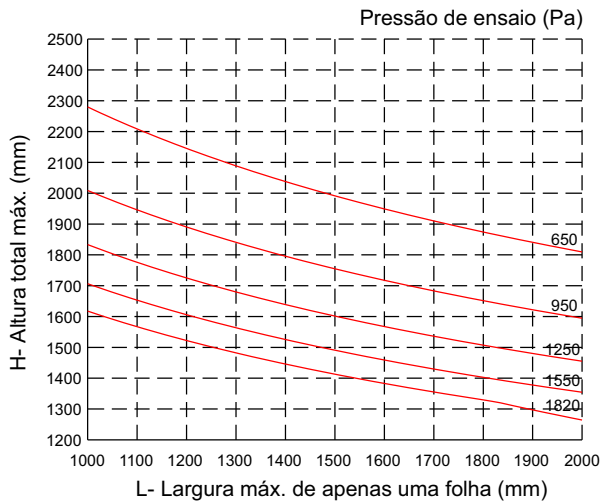
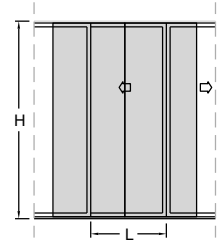

RO049	RO049	RO049	RO049
Área = 425 mm ²	Área = 425 mm ²	Área = 425 mm ²	Área = 425 mm ²
Jx = 125346 mm ⁴	Jx = 125346 mm ⁴	Jx = 125346 mm ⁴	Jx = 125346 mm ⁴
Wx = 5454 mm ³	Wx = 5454 mm ³	Wx = 5454 mm ³	Wx = 5454 mm ³
Jx total = 250692 mm⁴		Jx total = 250692 mm⁴	

Tensão admissível = 7 kg/mm² (liga 6060-T5)

Flecha admissível = H / 175

Janela e porta de correr - 2 e 3 planos com encontro central

Notas:

A largura do gráfico refere-se a apenas uma folha, ou seja, para obter a largura total da esquadria deve-se multiplicar a medida máxima encontrada no gráfico pela quantidade de folhas da tipologia.

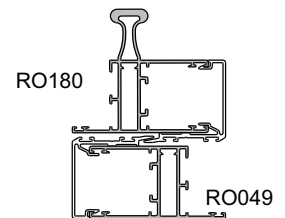
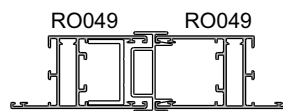
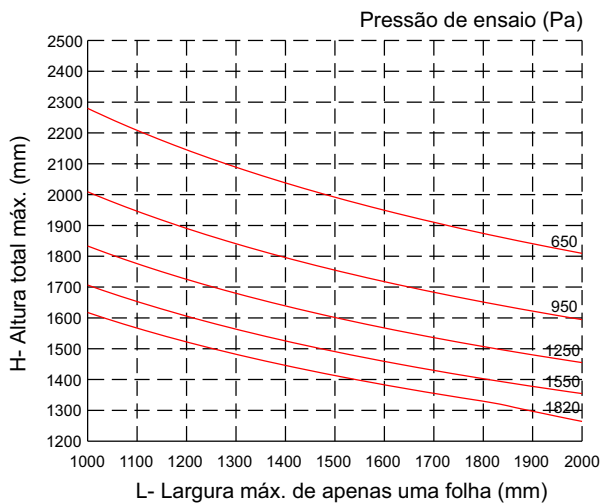
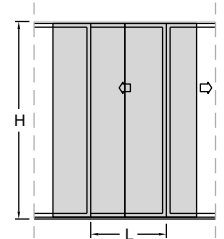

RO049	RO049	RO049	RO180
Área = 425 mm ²	Área = 425 mm ²	Área = 425 mm ²	Área = 618 mm ²
Jx = 125346 mm ⁴	Jx = 125346 mm ⁴	Jx = 125346 mm ⁴	Jx = 392911 mm ⁴
Wx = 5454 mm ³	Wx = 5454 mm ³	Wx = 5454 mm ³	Wx = 9974 mm ³
Jx total = 250692 mm⁴		Jx total = 518257 mm⁴	

Tensão admissível = 7 kg/mm² (liga 6060-T5)

Flecha admissível = H / 175

Janela e porta de correr - 2 e 3 planos com encontro central

Notas:

A largura do gráfico refere-se a apenas uma folha, ou seja, para obter a largura total da esquadria deve-se multiplicar a medida máxima encontrada no gráfico pela quantidade de folhas da tipologia.

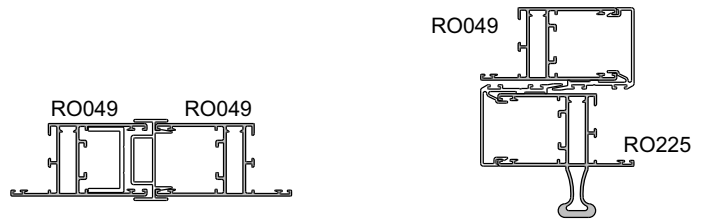
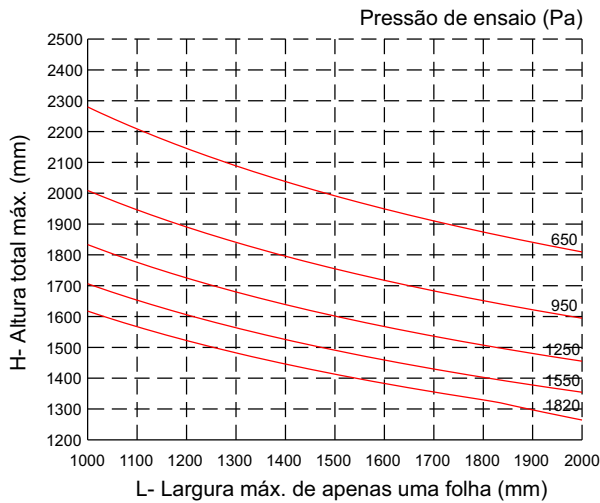
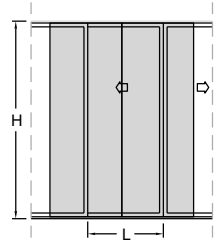

RO049	RO049	RO049	RO225
Área = 425 mm ²	Área = 425 mm ²	Área = 425 mm ²	Área = 618 mm ²
Jx = 125346 mm ⁴	Jx = 125346 mm ⁴	Jx = 125346 mm ⁴	Jx = 355914 mm ⁴
Wx = 5454 mm ³	Wx = 5454 mm ³	Wx = 5454 mm ³	Wx = 9590 mm ³
Jx total = 250692 mm⁴		Jx total = 481260 mm⁴	

Tensão admissível = 7 kg/mm² (liga 6060-T5)

Flecha admissível = H / 175

Janela e porta de correr - 2 e 3 planos com encontro central

Notas:

A largura do gráfico refere-se a apenas uma folha, ou seja, para obter a largura total da esquadria deve-se multiplicar a medida máxima encontrada no gráfico pela quantidade de folhas da tipologia.

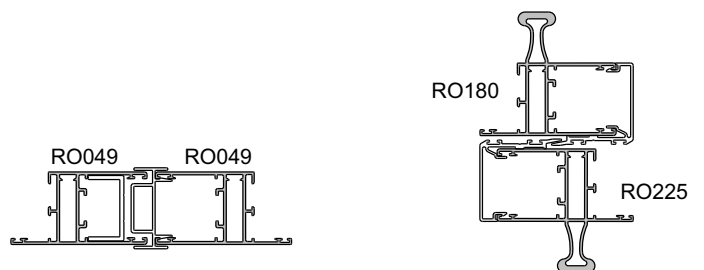
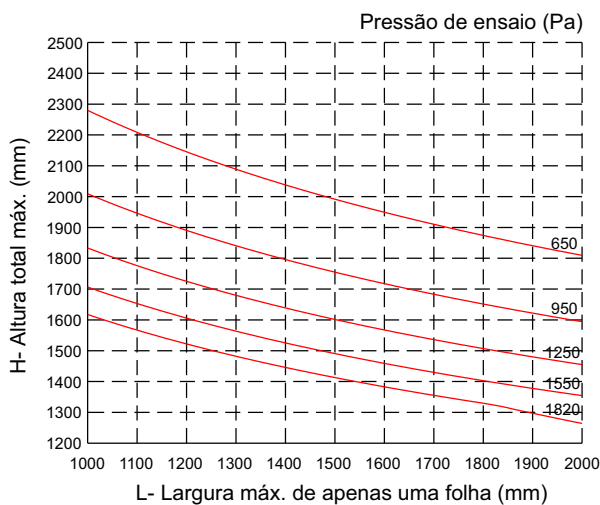
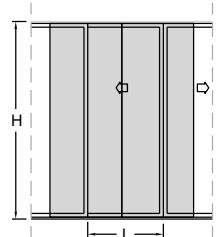

RO049	RO049	RO180	RO225
Área = 425 mm ²	Área = 425 mm ²	Área = 618 mm ²	Área = 618 mm ²
Jx = 125346 mm ⁴	Jx = 125346 mm ⁴	Jx = 392911 mm ⁴	Jx = 355914 mm ⁴
Wx = 5454 mm ³	Wx = 5454 mm ³	Wx = 9974 mm ³	Wx = 9590 mm ³
Jx total = 250692 mm⁴		Jx total = 748825 mm⁴	

Tensão admissível = 7 kg/mm² (liga 6060-T5)

Flecha admissível = H / 175

Janela e porta de correr - 2 e 3 planos com encontro central

Notas:

A largura do gráfico refere-se a apenas uma folha, ou seja, para obter a largura total da esquadria deve-se multiplicar a medida máxima encontrada no gráfico pela quantidade de folhas da tipologia.

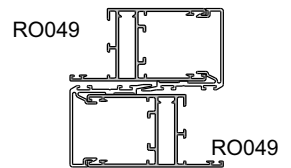
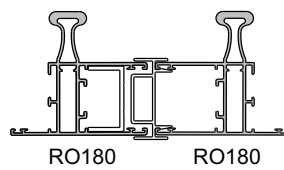
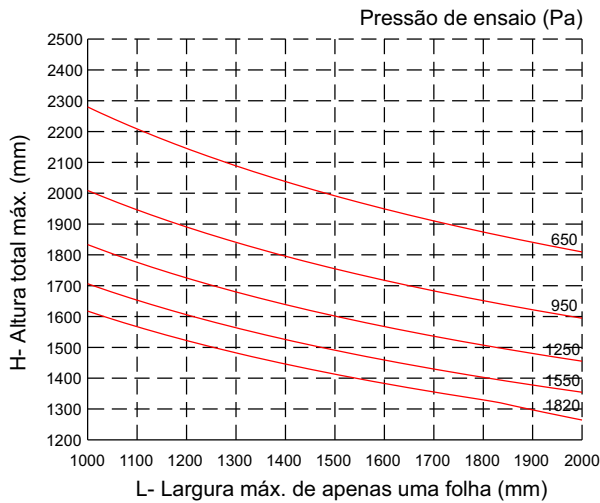
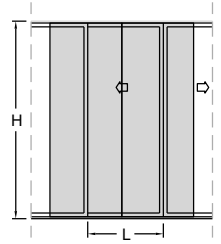

Tensão admissível = 7 kg/mm² (liga 6060-T5)

Flecha admissível = H / 175

RO180	RO180	RO049	RO049
Área = 618 mm ²	Área = 618 mm ²	Área = 425 mm ²	Área = 425 mm ²
Jx = 392911 mm ⁴	Jx = 392911 mm ⁴	Jx = 125346 mm ⁴	Jx = 125346 mm ⁴
Wx = 9974 mm ³	Wx = 9974 mm ³	Wx = 5454 mm ³	Wx = 5454 mm ³
Jx total = 785822 mm⁴		Jx total = 250692 mm⁴	

Janela e porta de correr - 2 e 3 planos com encontro central

Notas:

A largura do gráfico refere-se a apenas uma folha, ou seja, para obter a largura total da esquadria deve-se multiplicar a medida máxima encontrada no gráfico pela quantidade de folhas da tipologia.

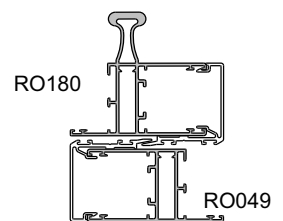
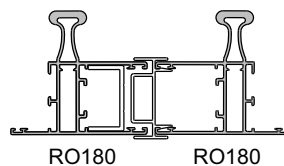
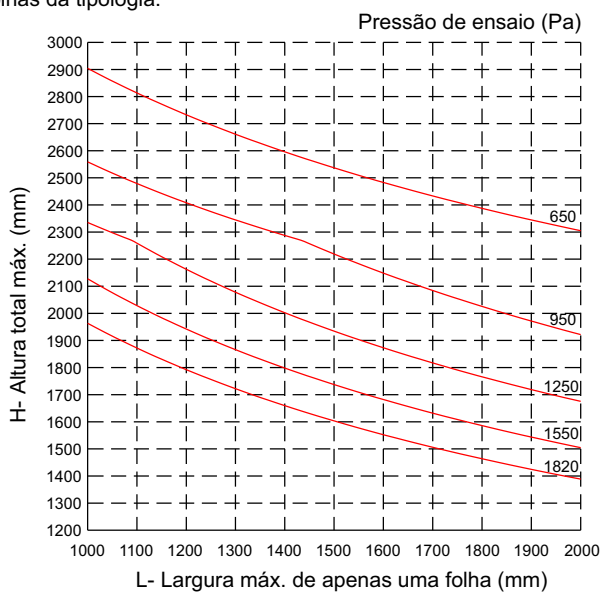
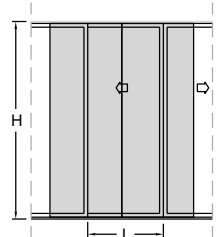

Tensão admissível = 7 kg/mm² (liga 6060-T5)

Flecha admissível = H / 175

RO180	RO180	RO049	RO180
Área = 618 mm ²	Área = 618 mm ²	Área = 425 mm ²	Área = 618 mm ²
Jx = 392911 mm ⁴	Jx = 392911 mm ⁴	Jx = 125346 mm ⁴	Jx = 392911 mm ⁴
Wx = 9974 mm ³	Wx = 9974 mm ³	Wx = 5454 mm ³	Wx = 9974 mm ³
Jx total = 785822 mm⁴		Jx total = 518257 mm⁴	

Janela e porta de correr - 2 e 3 planos com encontro central

Notas:

A largura do gráfico refere-se a apenas uma folha, ou seja, para obter a largura total da esquadria deve-se multiplicar a medida máxima encontrada no gráfico pela quantidade de folhas da tipologia.

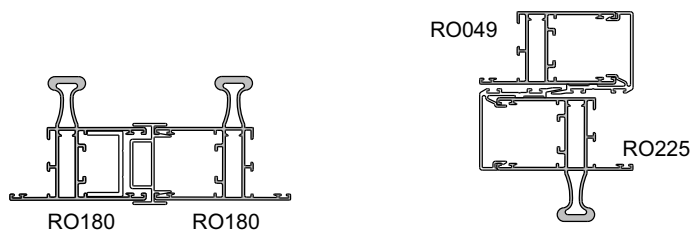
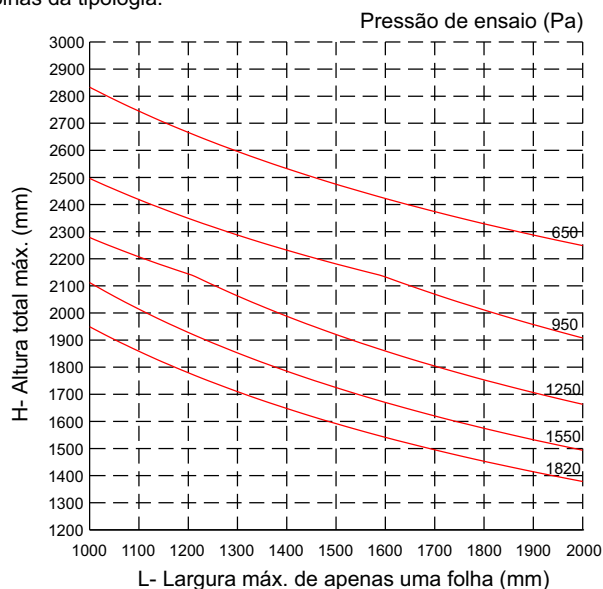
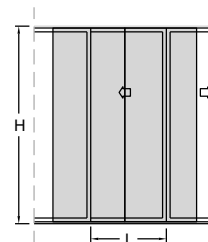

RO180	RO180	RO049	RO225
Área = 618 mm ²	Área = 618 mm ²	Área = 425 mm ²	Área = 618 mm ²
Jx = 392911 mm ⁴	Jx = 392911 mm ⁴	Jx = 125346 mm ⁴	Jx = 355914 mm ⁴
Wx = 9974 mm ³	Wx = 9974 mm ³	Wx = 5454 mm ³	Wx = 9590 mm ³
Jx total = 785822 mm⁴		Jx total = 481260 mm⁴	

Tensão admissível = 7 kg/mm² (liga 6060-T5)

Flecha admissível = H / 175

Janela e porta de correr - 2 e 3 planos com encontro central

Notas:

A largura do gráfico refere-se a apenas uma folha, ou seja, para obter a largura total da esquadria deve-se multiplicar a medida máxima encontrada no gráfico pela quantidade de folhas da tipologia.

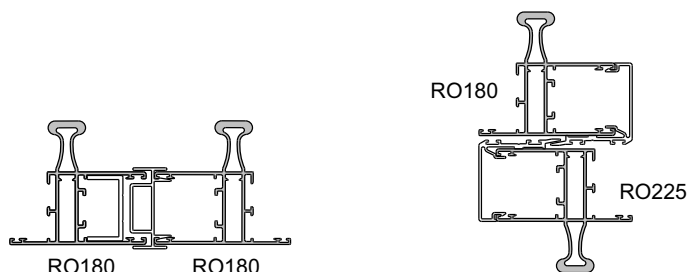
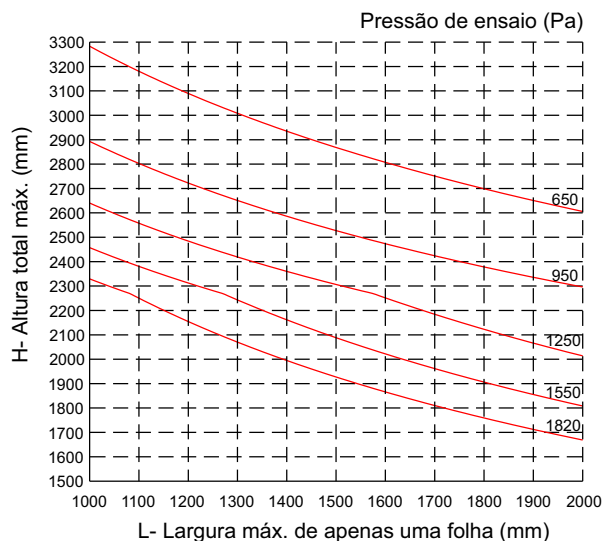
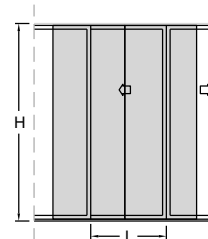

RO180	RO180	RO180	RO225
Área = 618 mm ²	Área = 618 mm ²	Área = 618 mm ²	Área = 618 mm ²
Jx = 392911 mm ⁴	Jx = 392911 mm ⁴	Jx = 392911 mm ⁴	Jx = 355914 mm ⁴
Wx = 9974 mm ³	Wx = 9974 mm ³	Wx = 9974 mm ³	Wx = 9590 mm ³
Jx total = 785822 mm⁴		Jx total = 748825 mm⁴	

Tensão admissível = 7 kg/mm² (liga 6060-T5)

Flecha admissível = H / 175

Janela e porta de correr - 2 e 3 planos com encontro central

Notas:

A largura do gráfico refere-se a apenas uma folha, ou seja, para obter a largura total da esquadria deve-se multiplicar a medida máxima encontrada no gráfico pela quantidade de folhas da tipologia.

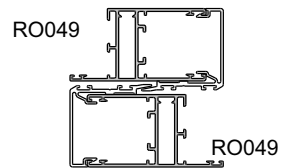
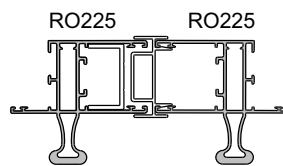
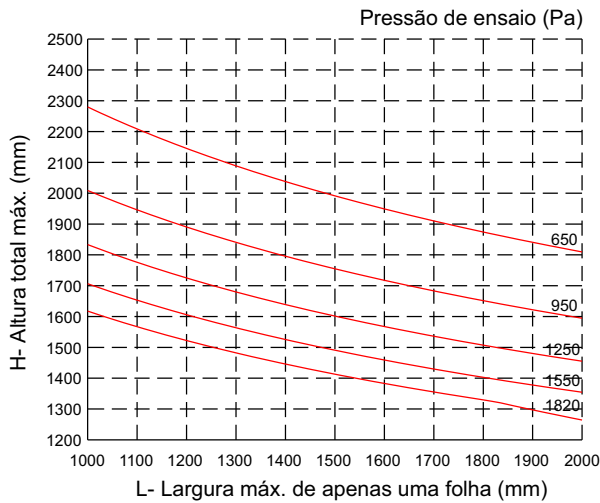
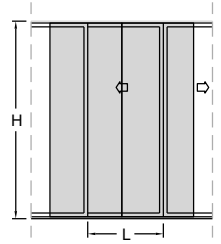

RO225	RO225	RO049	RO049
Área = 618 mm ²	Área = 618 mm ²	Área = 425 mm ²	Área = 425 mm ²
Jx = 355914 mm ⁴	Jx = 355914 mm ⁴	Jx = 125346 mm ⁴	Jx = 125346 mm ⁴
Wx = 9590 mm ³	Wx = 9590 mm ³	Wx = 5454 mm ³	Wx = 5454 mm ³
Jx total = 711828 mm⁴		Jx total = 250692 mm⁴	

Tensão admissível = 7 kg/mm² (liga 6060-T5)

Flecha admissível = H / 175

Janela e porta de correr - 2 e 3 planos com encontro central

Notas:

A largura do gráfico refere-se a apenas uma folha, ou seja, para obter a largura total da esquadria deve-se multiplicar a medida máxima encontrada no gráfico pela quantidade de folhas da tipologia.

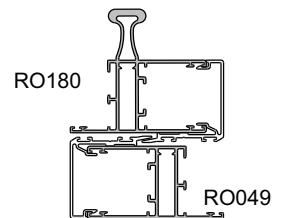
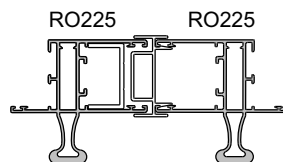
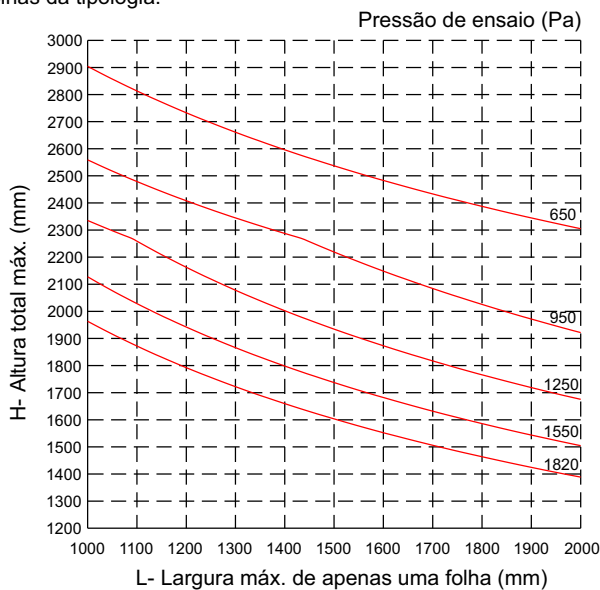
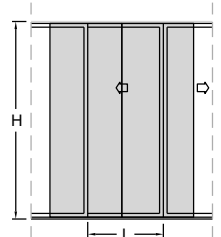

RO225	RO225	RO049	RO180
Área = 618 mm ²	Área = 618 mm ²	Área = 425 mm ²	Área = 618 mm ²
Jx = 355914 mm ⁴	Jx = 355914 mm ⁴	Jx = 125346 mm ⁴	Jx = 392911 mm ⁴
Wx = 9590 mm ³	Wx = 9590 mm ³	Wx = 5454 mm ³	Wx = 9974 mm ³
Jx total = 711828 mm⁴		Jx total = 518257 mm⁴	

Tensão admissível = 7 kg/mm² (liga 6060-T5)

Flecha admissível = H / 175

Janela e porta de correr - 2 e 3 planos com encontro central

Notas:

A largura do gráfico refere-se a apenas uma folha, ou seja, para obter a largura total da esquadria deve-se multiplicar a medida máxima encontrada no gráfico pela quantidade de folhas da tipologia.

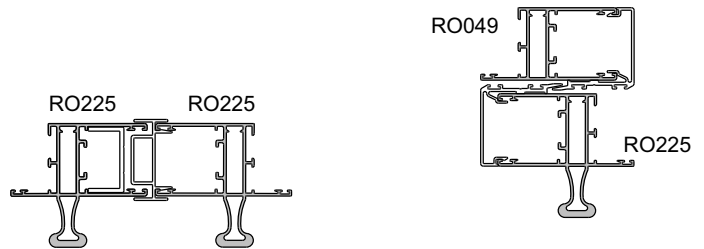
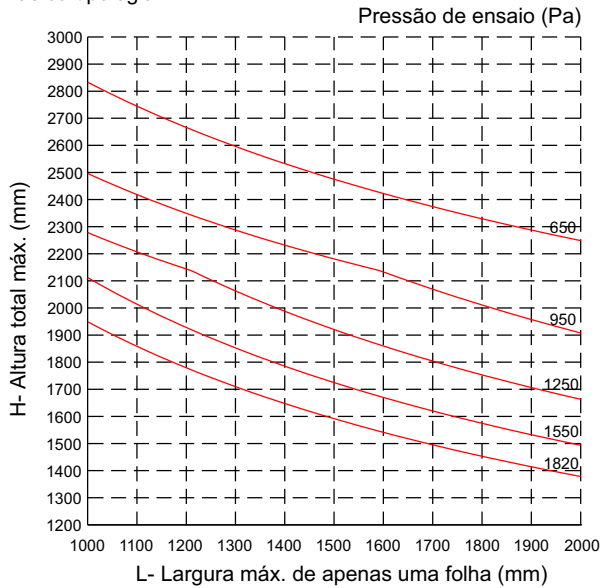
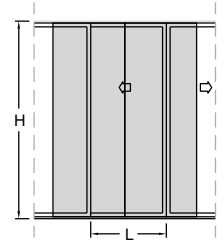

RO225	RO225	RO049	RO225
Área = 618 mm ²	Área = 618 mm ²	Área = 425 mm ²	Área = 618 mm ²
Jx = 355914 mm ⁴	Jx = 355914 mm ⁴	Jx = 125346 mm ⁴	Jx = 355914 mm ⁴
Wx = 9590 mm ³	Wx = 9590 mm ³	Wx = 5454 mm ³	Wx = 9590 mm ³
Jx total = 711828 mm⁴		Jx total = 481260 mm⁴	

Tensão admissível = 7 kg/mm² (liga 6060-T5)

Flecha admissível = H / 175

Janela e porta de correr - 2 e 3 planos com encontro central

Notas:

A largura do gráfico refere-se a apenas uma folha, ou seja, para obter a largura total da esquadria deve-se multiplicar a medida máxima encontrada no gráfico pela quantidade de folhas da tipologia.

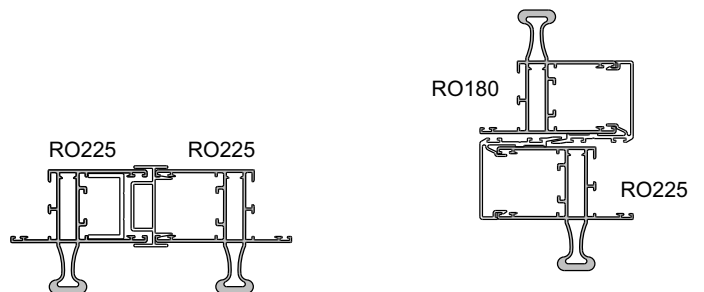
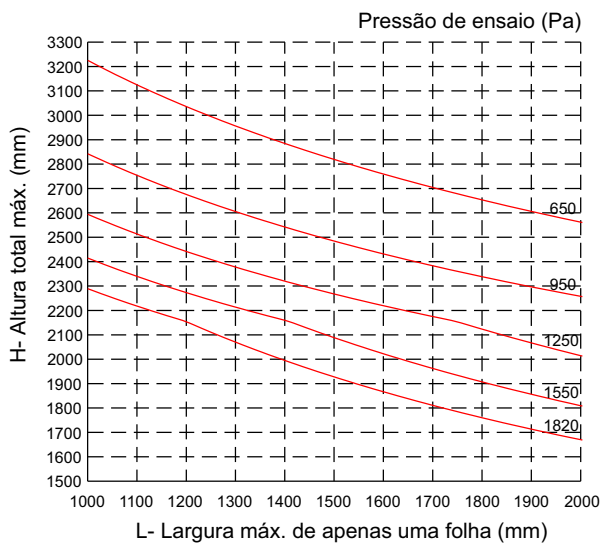
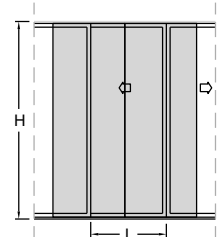

RO225	RO225	RO180	RO225
Área = 618 mm ²	Área = 618 mm ²	Área = 618 mm ²	Área = 618 mm ²
Jx = 355914 mm ⁴	Jx = 355914 mm ⁴	Jx = 392911 mm ⁴	Jx = 355914 mm ⁴
Wx = 9590 mm ³	Wx = 9590 mm ³	Wx = 9974 mm ³	Wx = 9590 mm ³
Jx total = 711828 mm⁴		Jx total = 748825 mm⁴	

Tensão admissível = 7 kg/mm² (liga 6060-T5)

Flecha admissível = H / 175

Janela e porta de correr - 2 e 3 planos com encontro central

Notas:

A largura do gráfico refere-se a apenas uma folha, ou seja, para obter a largura total da esquadria deve-se multiplicar a medida máxima encontrada no gráfico pela quantidade de folhas da tipologia.

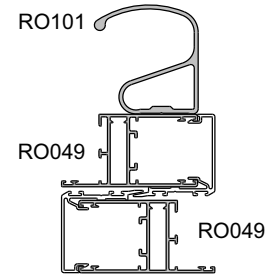
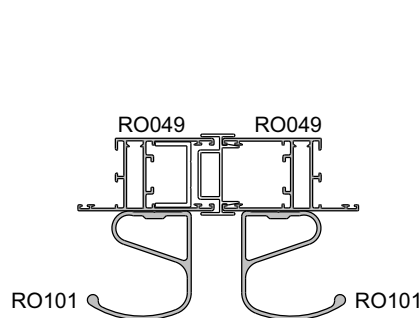
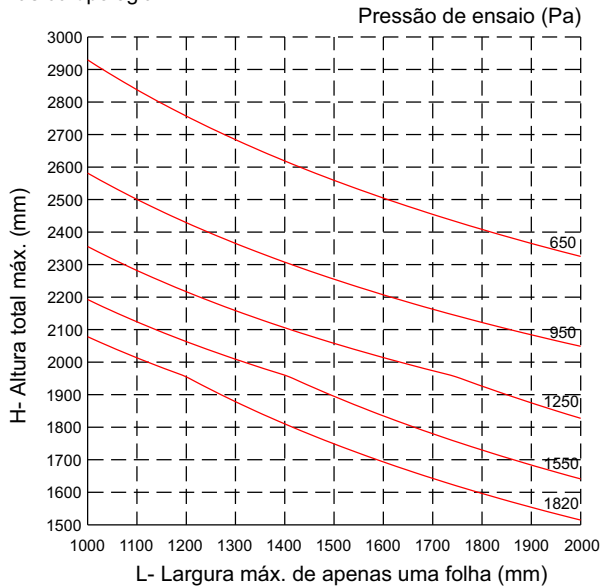
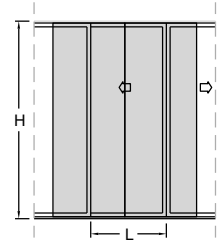

RO049 (2x)	RO101 (2x)	RO049 (2x)	RO101 (1x)
Área = 850 mm ²	Área = 1100 mm ²	Área = 850 mm ²	Área = 550 mm ²
Jx = 250692 mm ⁴	Jx = 562518 mm ⁴	Jx = 250692 mm ⁴	Jx = 281259 mm ⁴
Wx = 10908 mm ³	Wx = 16554 mm ³	Wx = 10908 mm ³	Wx = 8277 mm ³
Jx total = 813210 mm⁴		Jx total = 531951 mm⁴	

Tensão admissível = 7 kg/mm² (liga 6060-T5)

Flecha admissível = H / 175

Janela e porta de correr - 2 e 3 planos com encontro central

Notas:

A largura do gráfico refere-se a apenas uma folha, ou seja, para obter a largura total da esquadria deve-se multiplicar a medida máxima encontrada no gráfico pela quantidade de folhas da tipologia.

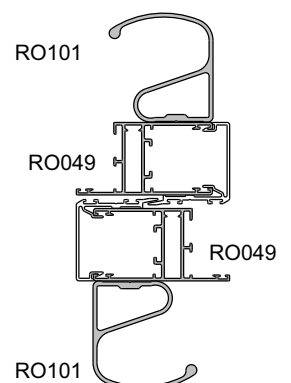
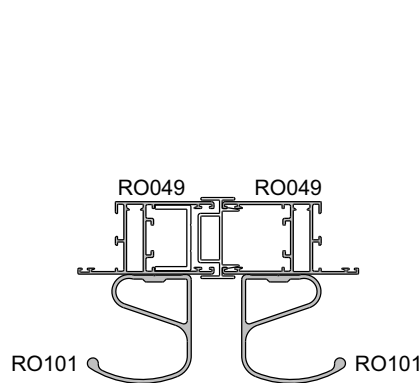
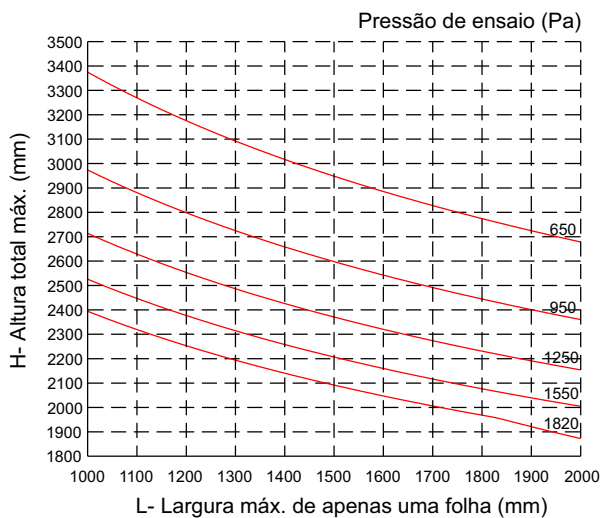
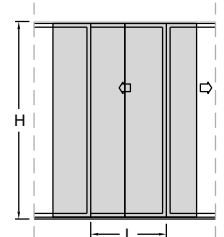

RO049 (2x)	RO101 (2x)	RO049 (2x)	RO101 (2x)
Área = 850 mm ²	Área = 1100 mm ²	Área = 850 mm ²	Área = 1100 mm ²
Jx = 250692 mm ⁴	Jx = 562518 mm ⁴	Jx = 250692 mm ⁴	Jx = 562518 mm ⁴
Wx = 10908 mm ³	Wx = 16554 mm ³	Wx = 10908 mm ³	Wx = 16554 mm ³
Jx total = 813210 mm⁴		Jx total = 813210 mm⁴	

Tensão admissível = 7 kg/mm² (liga 6060-T5)

Flecha admissível = H / 175

Porta de correr - 2 e 3 planos com encontro central

Notas:

A largura do gráfico refere-se a apenas uma folha, ou seja, para obter a largura total da esquadria deve-se multiplicar a medida máxima encontrada no gráfico pela quantidade de folhas da tipologia.

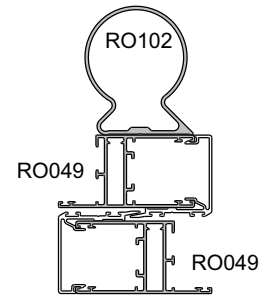
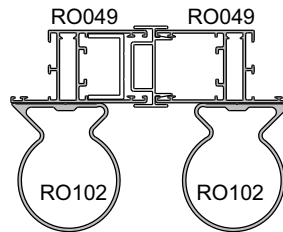
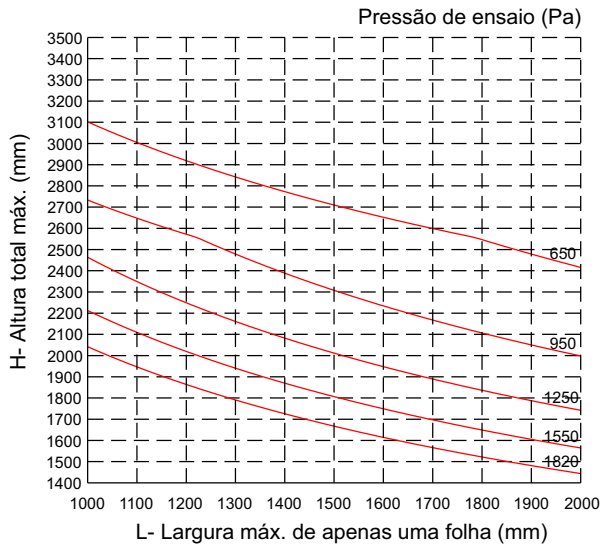
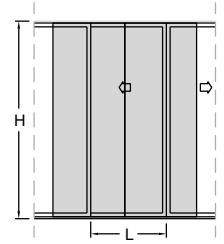

RO049 (2x)	RO102 (2x)	RO049 (2x)	RO102 (1x)
Área = 850 mm ²	Área = 1076 mm ²	Área = 850 mm ²	Área = 538 mm ²
Jx = 250692 mm ⁴	Jx = 761742 mm ⁴	Jx = 250692 mm ⁴	Jx = 380871 mm ⁴
Wx = 10908 mm ³	Wx = 17160 mm ³	Wx = 10908 mm ³	Wx = 8580 mm ³
Jx total = 1012434 mm⁴		Jx total = 631563 mm⁴	

Tensão admissível = 7 kg/mm² (liga 6060-T5)

Flecha admissível = H / 175

Porta de correr - 2 e 3 planos com encontro central

Notas:

A largura do gráfico refere-se a apenas uma folha, ou seja, para obter a largura total da esquadria deve-se multiplicar a medida máxima encontrada no gráfico pela quantidade de folhas da tipologia.

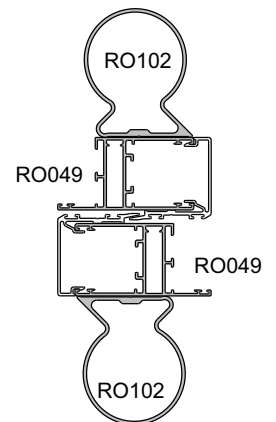
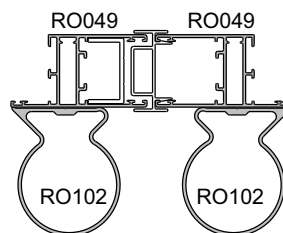
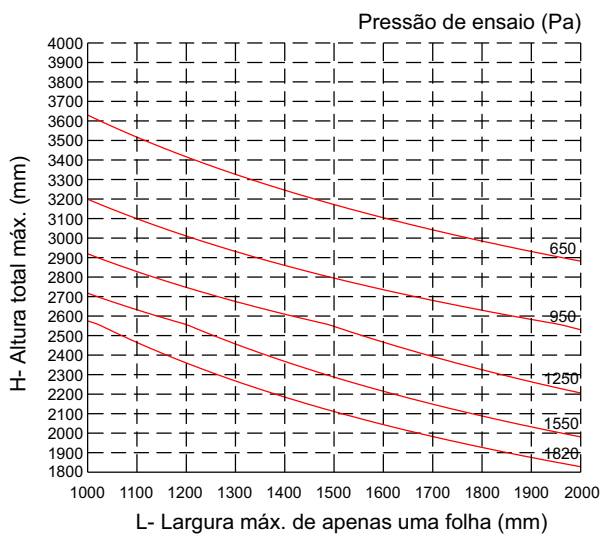
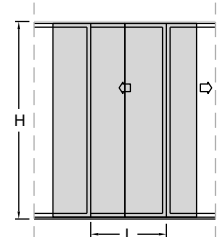

RO049 (2x)	RO102 (2x)	RO049 (2x)	RO102 (2x)
Área = 850 mm ²	Área = 1076 mm ²	Área = 850 mm ²	Área = 1076 mm ²
Jx = 250692 mm ⁴	Jx = 761742 mm ⁴	Jx = 250692 mm ⁴	Jx = 761742 mm ⁴
Wx = 10908 mm ³	Wx = 17160 mm ³	Wx = 10908 mm ³	Wx = 17160 mm ³
Jx total = 1012434 mm⁴		Jx total = 1012434 mm⁴	

Tensão admissível = 7 kg/mm² (liga 6060-T5)

Flecha admissível = H / 175

Porta de correr - 2 e 3 planos com encontro central

Notas:

A largura do gráfico refere-se a apenas uma folha, ou seja, para obter a largura total da esquadria deve-se multiplicar a medida máxima encontrada no gráfico pela quantidade de folhas da tipologia.

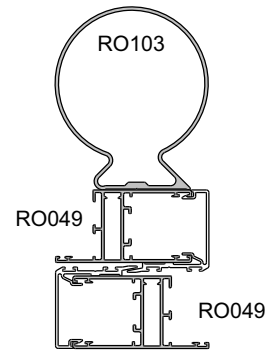
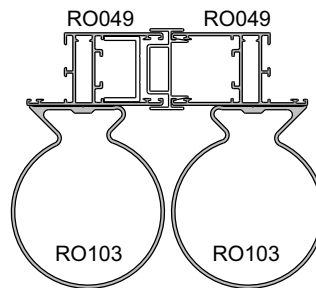
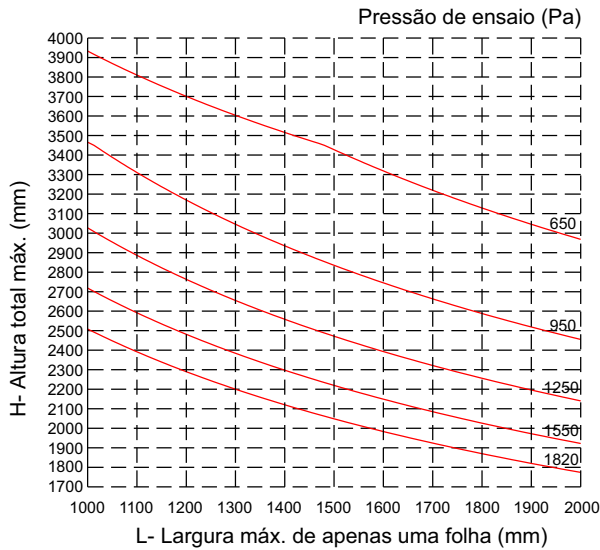
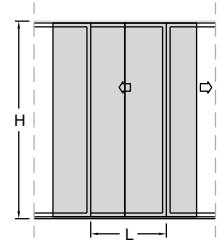

RO049 (2x)	RO103 (2x)	RO049 (2x)	RO103 (1x)
Área = 850 mm ²	Área = 1458 mm ²	Área = 850 mm ²	Área = 729 mm ²
Jx = 250692 mm ⁴	Jx = 2073292 mm ⁴	Jx = 250692 mm ⁴	Jx = 1036646 mm ⁴
Wx = 10908 mm ³	Wx = 21816 mm ³	Wx = 10908 mm ³	Wx = 10908 mm ³
Jx total = 2323984 mm⁴		Jx total = 1287338 mm⁴	

Tensão admissível = 7 kg/mm² (liga 6060-T5)

Flecha admissível = H / 175

Porta de correr - 2 e 3 planos com encontro central

Notas:

A largura do gráfico refere-se a apenas uma folha, ou seja, para obter a largura total da esquadria deve-se multiplicar a medida máxima encontrada no gráfico pela quantidade de folhas da tipologia.

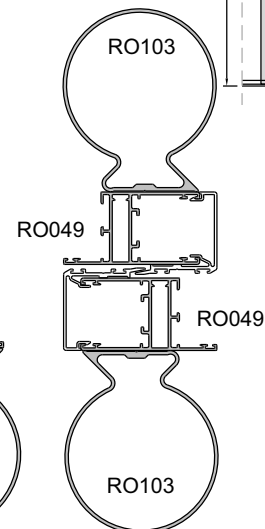
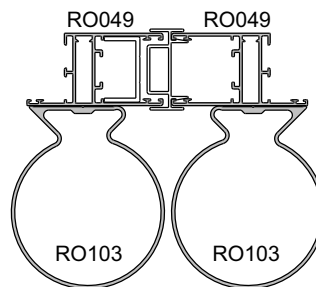
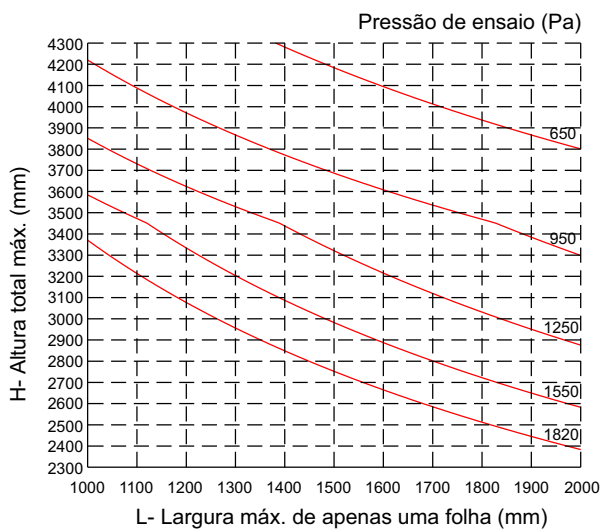
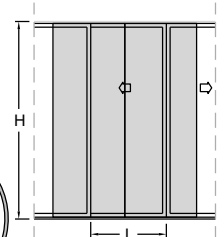

RO049 (2x)	RO103 (2x)	RO049 (2x)	RO103 (2x)
Área = 850 mm ²	Área = 1458 mm ²	Área = 850 mm ²	Área = 1458 mm ²
Jx = 250692 mm ⁴	Jx = 2073292 mm ⁴	Jx = 250692 mm ⁴	Jx = 2073292 mm ⁴
Wx = 10908 mm ³	Wx = 21816 mm ³	Wx = 10908 mm ³	Wx = 21816 mm ³
Jx total = 2323984 mm⁴		Jx total = 2323984 mm⁴	

Tensão admissível = 7 kg/mm² (liga 6060-T5)

Flecha admissível = H / 175

Porta de correr - 2 e 3 planos com encontro central

Notas:

A largura do gráfico refere-se a apenas uma folha, ou seja, para obter a largura total da esquadria deve-se multiplicar a medida máxima encontrada no gráfico pela quantidade de folhas da tipologia.

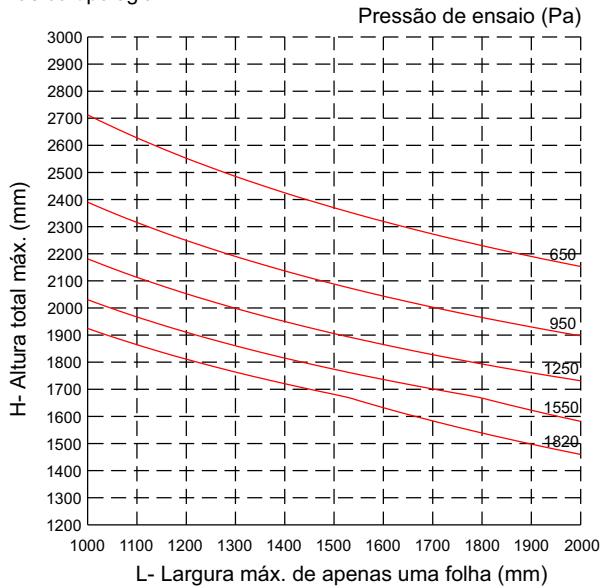

Tensão admissível = 7 kg/mm² (liga 6060-T5)

Flecha admissível = H / 175

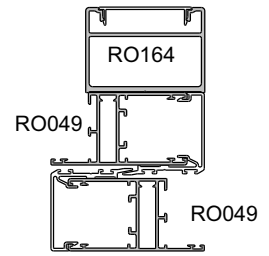
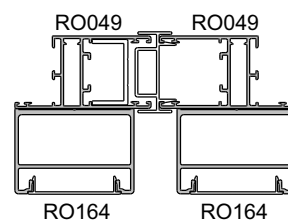

RO049 (2x)	RO164 (2x)	RO049 (2x)	RO164 (1x)
Área = 850 mm ²	Área = 1158 mm ²	Área = 850 mm ²	Área = 579 mm ²
Jx = 250692 mm ⁴	Jx = 343360 mm ⁴	Jx = 250692 mm ⁴	Jx = 171680 mm ⁴
Wx = 10908 mm ³	Wx = 11822 mm ³	Wx = 10908 mm ³	Wx = 5911 mm ³
Jx total = 594052 mm⁴		Jx total = 422372 mm⁴	

Porta de correr - 2 e 3 planos com encontro central

Notas:

A largura do gráfico refere-se a apenas uma folha, ou seja, para obter a largura total da esquadria deve-se multiplicar a medida máxima encontrada no gráfico pela quantidade de folhas da tipologia.

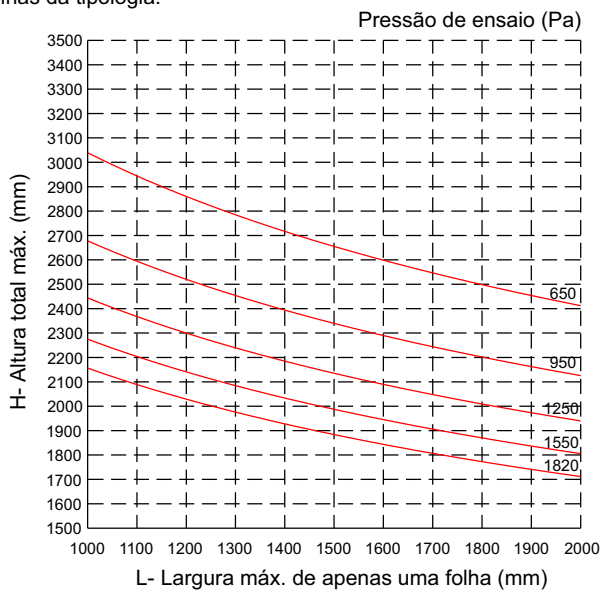

Tensão admissível = 7 kg/mm² (liga 6060-T5)

Flecha admissível = H / 175

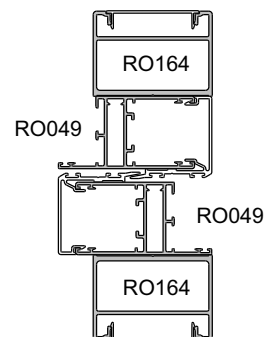
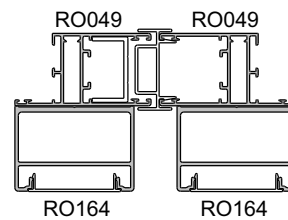

RO049 (2x)	RO164 (2x)	RO049 (2x)	RO164 (2x)
Área = 850 mm ²	Área = 1158 mm ²	Área = 850 mm ²	Área = 1158 mm ²
Jx = 250692 mm ⁴	Jx = 343360 mm ⁴	Jx = 250692 mm ⁴	Jx = 343360 mm ⁴
Wx = 10908 mm ³	Wx = 11822 mm ³	Wx = 10908 mm ³	Wx = 11822 mm ³
Jx total = 594052 mm⁴		Jx total = 594052 mm⁴	

Porta de correr - 2 e 3 planos com encontro central

Notas:

A largura do gráfico refere-se a apenas uma folha, ou seja, para obter a largura total da esquadria deve-se multiplicar a medida máxima encontrada no gráfico pela quantidade de folhas da tipologia.

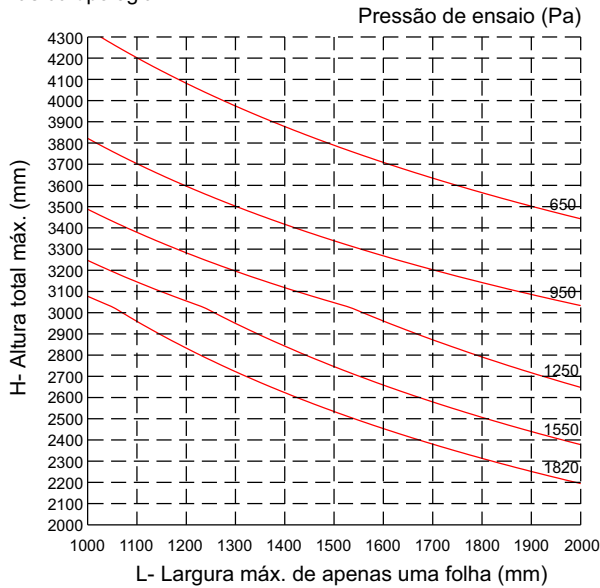

Tensão admissível = 7 kg/mm² (liga 6060-T5)

Flecha admissível = H / 175

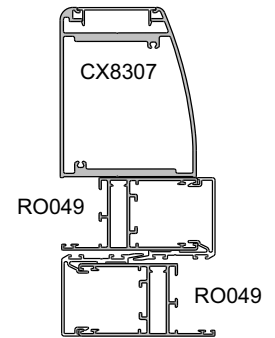
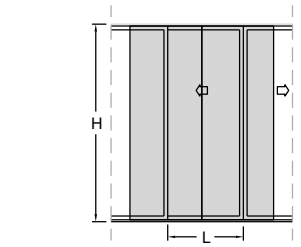
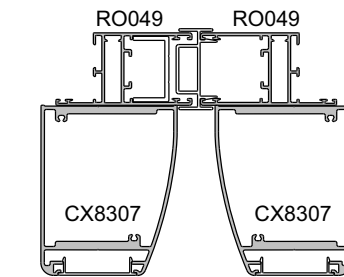

RO049 (2x)	CX8307 (2x)	RO049 (2x)	CX8307 (1x)
Área = 850 mm ²	Área = 2156 mm ²	Área = 850 mm ²	Área = 1078 mm ²
Jx = 250692 mm ⁴	Jx = 2952042 mm ⁴	Jx = 250692 mm ⁴	Jx = 1476021 mm ⁴
Wx = 10908 mm ³	Wx = 56196 mm ³	Wx = 10908 mm ³	Wx = 28098 mm ³
Jx total = 3202734 mm⁴		Jx total = 1726713 mm⁴	

Porta de correr - 2 e 3 planos com encontro central

Notas:

A largura do gráfico refere-se a apenas uma folha, ou seja, para obter a largura total da esquadria deve-se multiplicar a medida máxima encontrada no gráfico pela quantidade de folhas da tipologia.

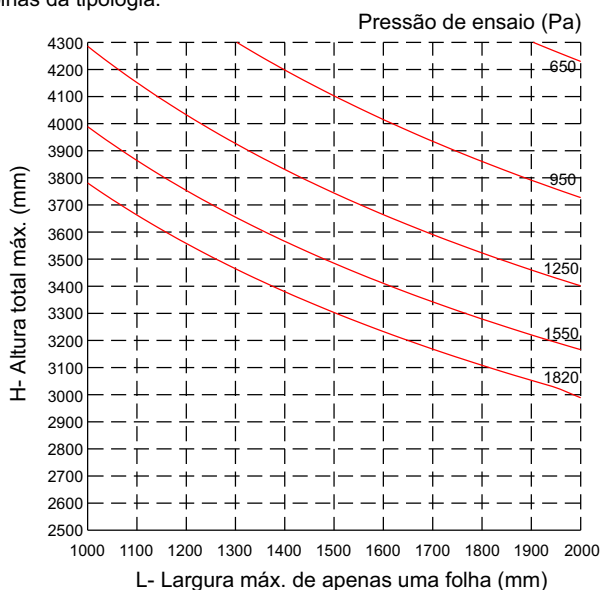

Tensão admissível = 7 kg/mm² (liga 6060-T5)

Flecha admissível = H / 175

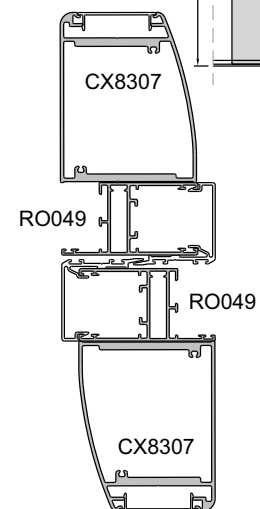
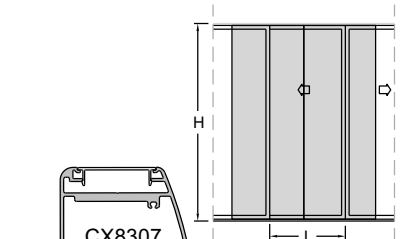
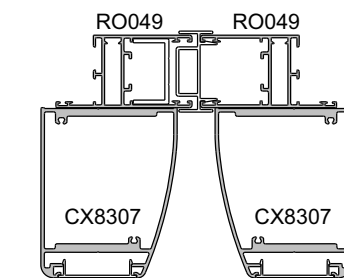

RO049 (2x)	CX8307 (2x)	RO049 (2x)	CX8307 (2x)
Área = 850 mm ²	Área = 2156 mm ²	Área = 850 mm ²	Área = 2156 mm ²
Jx = 250692 mm ⁴	Jx = 2952042 mm ⁴	Jx = 250692 mm ⁴	Jx = 2952042 mm ⁴
Wx = 10908 mm ³	Wx = 56196 mm ³	Wx = 10908 mm ³	Wx = 56196 mm ³
Jx total = 3202734 mm⁴		Jx total = 3202734 mm⁴	

Janela e porta de correr - 2, 3 e 4 planos

Notas:

A largura do gráfico refere-se a apenas uma folha, ou seja, para obter a largura total da esquadria deve-se multiplicar a medida máxima encontrada no gráfico pela quantidade de folhas da tipologia.

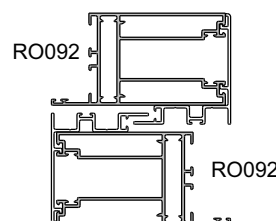
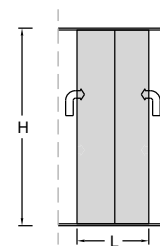
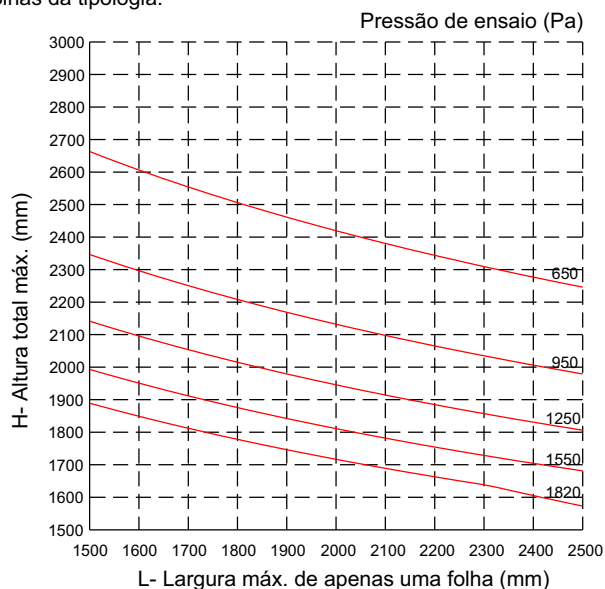

RO092	RO092
Área = 757 mm ²	Área = 757 mm ²
Jx = 299713 mm ⁴	Jx = 299713 mm ⁴
Wx = 10553 mm ³	Wx = 10553 mm ³
Jx total = 599426 mm⁴	

Tensão admissível = 7 kg/mm² (liga 6060-T5)

Flecha admissível = H / 175

Janela e porta de correr - 2, 3 e 4 planos

Notas:

A largura do gráfico refere-se a apenas uma folha, ou seja, para obter a largura total da esquadria deve-se multiplicar a medida máxima encontrada no gráfico pela quantidade de folhas da tipologia.

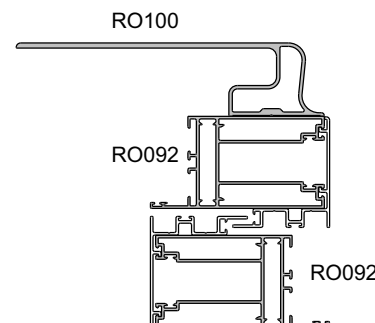
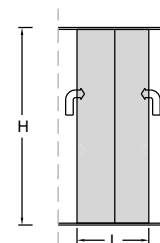
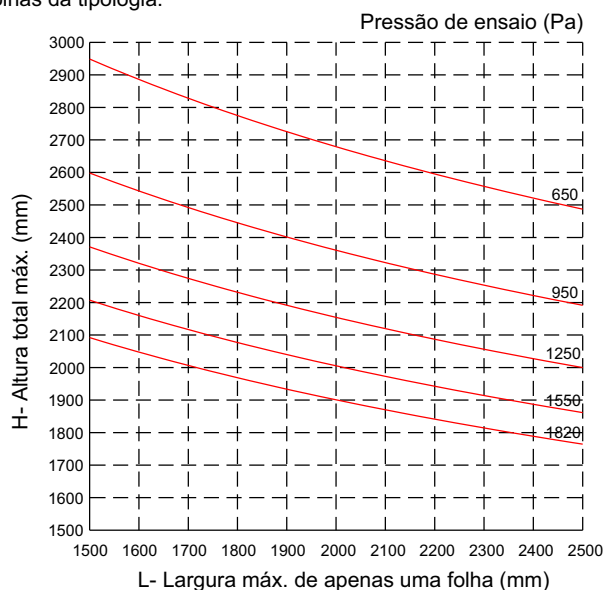

RO092	RO092	RO100
Área = 757 mm ²	Área = 757 mm ²	Área = 831 mm ²
Jx = 299713 mm ⁴	Jx = 299713 mm ⁴	Jx = 214344 mm ⁴
Wx = 10553 mm ³	Wx = 10553 mm ³	Wx = 10908 mm ³
Jx total = 813770 mm⁴		

Tensão admissível = 7 kg/mm² (liga 6060-T5)

Flecha admissível = H / 175

Janela e porta de correr - 2, 3 e 4 planos

Notas:

A largura do gráfico refere-se a apenas uma folha, ou seja, para obter a largura total da esquadria deve-se multiplicar a medida máxima encontrada no gráfico pela quantidade de folhas da tipologia.

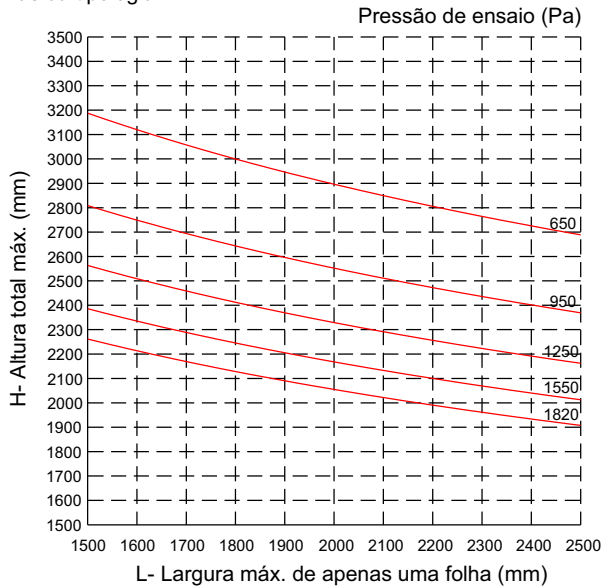

Tensão admissível = 7 kg/mm² (liga 6060-T5)

Flecha admissível = H / 175

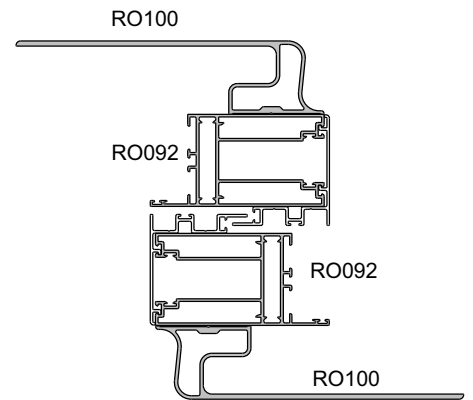
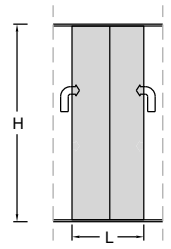

RO092	RO092	RO100	RO100
Área = 757 mm ²	Área = 757 mm ²	Área = 831 mm ²	Área = 831 mm ²
Jx = 299713 mm ⁴	Jx = 299713 mm ⁴	Jx = 214344 mm ⁴	Jx = 214344 mm ⁴
Wx = 10553 mm ³	Wx = 10553 mm ³	Wx = 10908 mm ³	Wx = 10908 mm ³
Jx total = 1028114 mm⁴			

Janela e porta de correr - 2, 3 e 4 planos

Notas:

A largura do gráfico refere-se a apenas uma folha, ou seja, para obter a largura total da esquadria deve-se multiplicar a medida máxima encontrada no gráfico pela quantidade de folhas da tipologia.

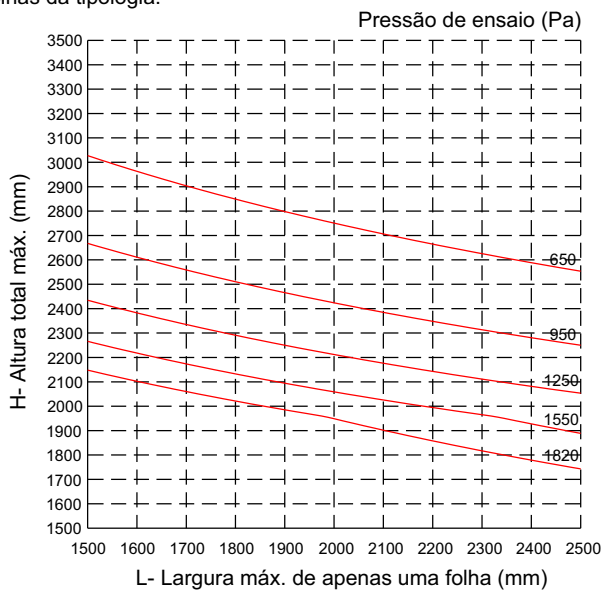

Tensão admissível = 7 kg/mm² (liga 6060-T5)

Flecha admissível = H / 175

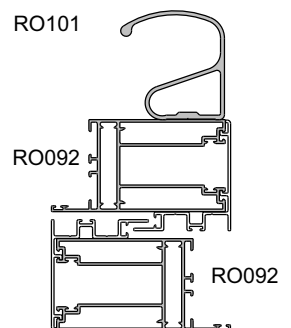
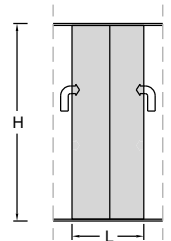

RO092	RO092	RO101
Área = 757 mm ²	Área = 757 mm ²	Área = 550 mm ²
Jx = 299713 mm ⁴	Jx = 299713 mm ⁴	Jx = 281259 mm ⁴
Wx = 10553 mm ³	Wx = 10553 mm ³	Wx = 8277 mm ³
Jx total = 880685 mm⁴		

Janela e porta de correr - 2, 3 e 4 planos

Notas:

A largura do gráfico refere-se a apenas uma folha, ou seja, para obter a largura total da esquadria deve-se multiplicar a medida máxima encontrada no gráfico pela quantidade de folhas da tipologia.

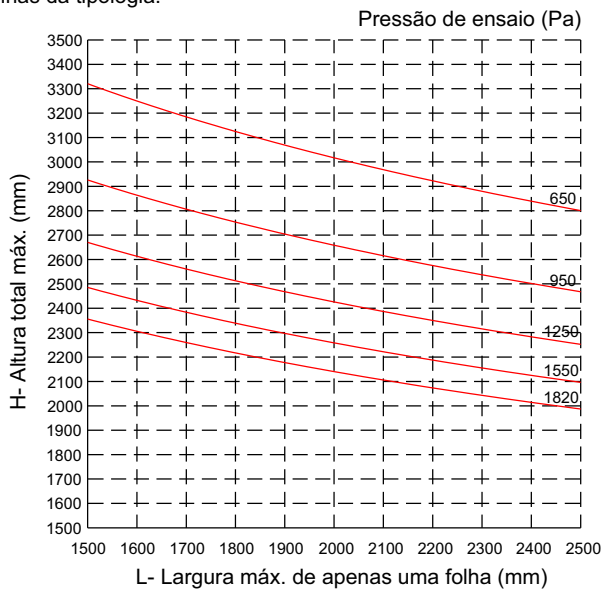

Tensão admissível = 7 kg/mm² (liga 6060-T5)

Flecha admissível = H / 175

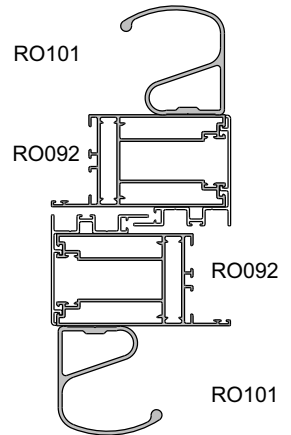
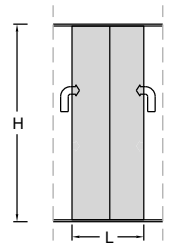

RO092	RO092	RO101	RO101
Área = 757 mm ²	Área = 757 mm ²	Área = 550 mm ²	Área = 550 mm ²
Jx = 299713 mm ⁴	Jx = 299713 mm ⁴	Jx = 281259 mm ⁴	Jx = 281259 mm ⁴
Wx = 10553 mm ³	Wx = 10553 mm ³	Wx = 8277 mm ³	Wx = 8277 mm ³
Jx total = 1161944 mm⁴			

Janela e porta de correr - 2, 3 e 4 planos

Notas:

A largura do gráfico refere-se a apenas uma folha, ou seja, para obter a largura total da esquadria deve-se multiplicar a medida máxima encontrada no gráfico pela quantidade de folhas da tipologia.

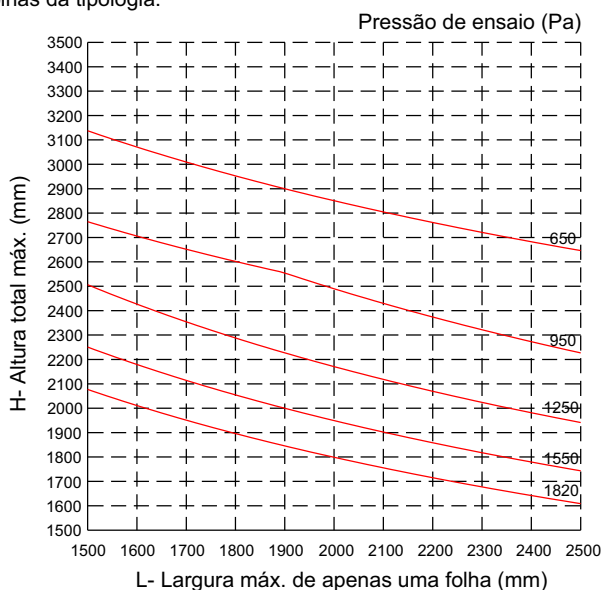

Tensão admissível = 7 kg/mm² (liga 6060-T5)

Flecha admissível = H / 175

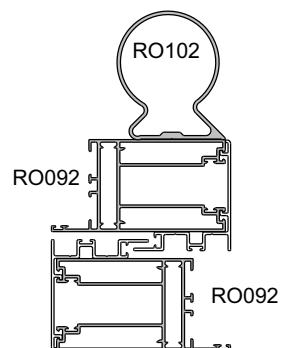
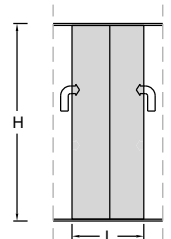

RO092	RO092	RO102
Área = 757 mm ²	Área = 757 mm ²	Área = 538 mm ²
Jx = 299713 mm ⁴	Jx = 299713 mm ⁴	Jx = 380871 mm ⁴
Wx = 10553 mm ³	Wx = 10553 mm ³	Wx = 8580 mm ³
Jx total = 980297 mm⁴		

Janela e porta de correr - 2, 3 e 4 planos

Notas:

A largura do gráfico refere-se a apenas uma folha, ou seja, para obter a largura total da esquadria deve-se multiplicar a medida máxima encontrada no gráfico pela quantidade de folhas da tipologia.

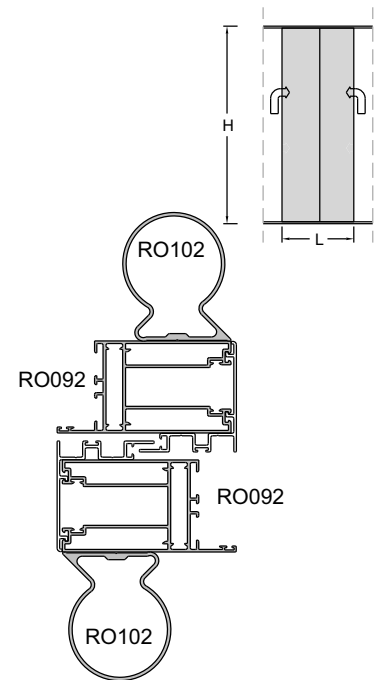
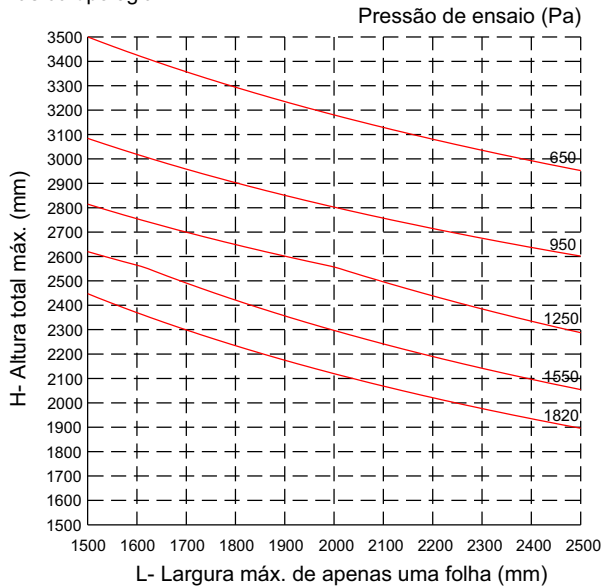

Tensão admissível = 7 kg/mm² (liga 6060-T5)

Flecha admissível = H / 175

RO092	RO092	RO102	RO102
Área = 757 mm ²	Área = 757 mm ²	Área = 538 mm ²	Área = 538 mm ²
Jx = 299713 mm ⁴	Jx = 299713 mm ⁴	Jx = 380871 mm ⁴	Jx = 380871 mm ⁴
Wx = 10553 mm ³	Wx = 10553 mm ³	Wx = 8580 mm ³	Wx = 8580 mm ³
Jx total = 1361168 mm⁴			

Janela e porta de correr - 2, 3 e 4 planos

Notas:

A largura do gráfico refere-se a apenas uma folha, ou seja, para obter a largura total da esquadria deve-se multiplicar a medida máxima encontrada no gráfico pela quantidade de folhas da tipologia.

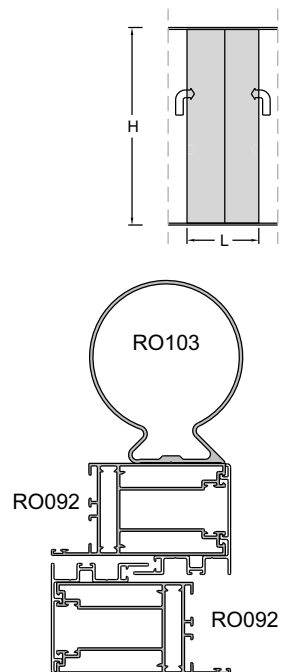
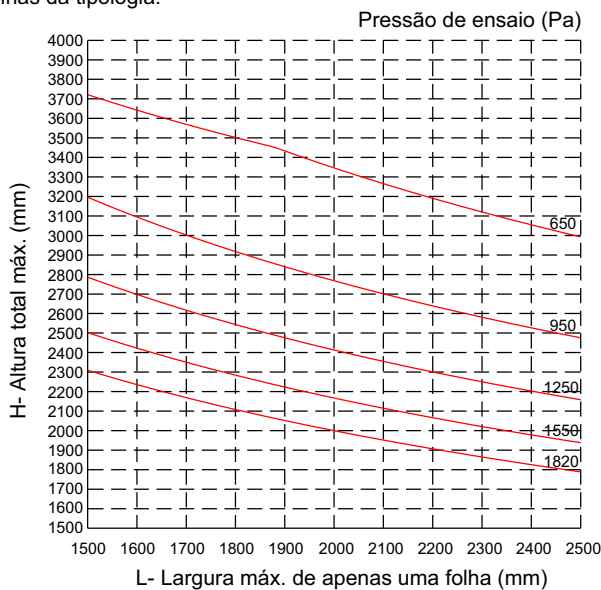

Tensão admissível = 7 kg/mm² (liga 6060-T5)

Flecha admissível = H / 175

RO092	RO092	RO103
Área = 757 mm ²	Área = 757 mm ²	Área = 729 mm ²
Jx = 299713 mm ⁴	Jx = 299713 mm ⁴	Jx = 1036646 mm ⁴
Wx = 10553 mm ³	Wx = 10553 mm ³	Wx = 10908 mm ³
Jx total = 1636072 mm⁴		

Janela e porta de correr - 2, 3 e 4 planos

Notas:

A largura do gráfico refere-se a apenas uma folha, ou seja, para obter a largura total da esquadria deve-se multiplicar a medida máxima encontrada no gráfico pela quantidade de folhas da tipologia.

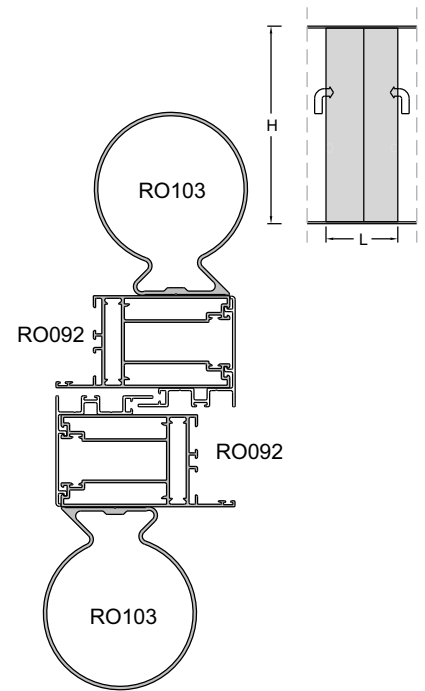
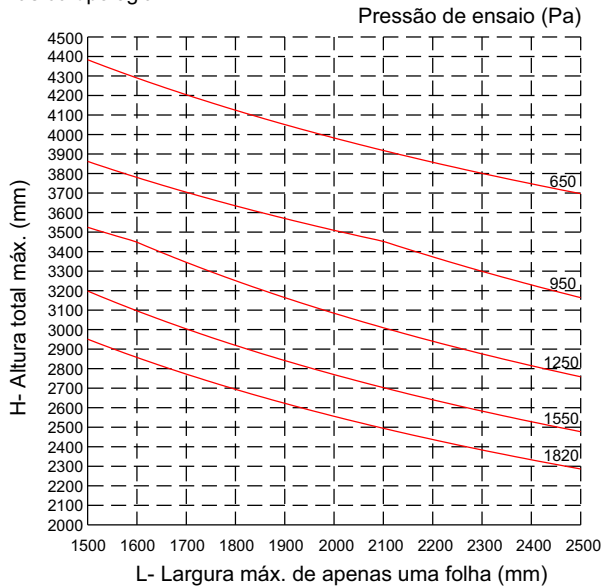

RO092	RO092	RO103	RO103
Área = 757 mm ²	Área = 757 mm ²	Área = 729 mm ²	Área = 729 mm ²
Jx = 299713 mm ⁴	Jx = 299713 mm ⁴	Jx = 1036646 mm ⁴	Jx = 1036646 mm ⁴
Wx = 10553 mm ³	Wx = 10553 mm ³	Wx = 10908 mm ³	Wx = 10908 mm ³
Jx total = 2672718 mm⁴			

Tensão admissível = 7 kg/mm² (liga 6060-T5)

Flecha admissível = H / 175

Janela e porta de correr - 2, 3 e 4 planos

Notas:

A largura do gráfico refere-se a apenas uma folha, ou seja, para obter a largura total da esquadria deve-se multiplicar a medida máxima encontrada no gráfico pela quantidade de folhas da tipologia.

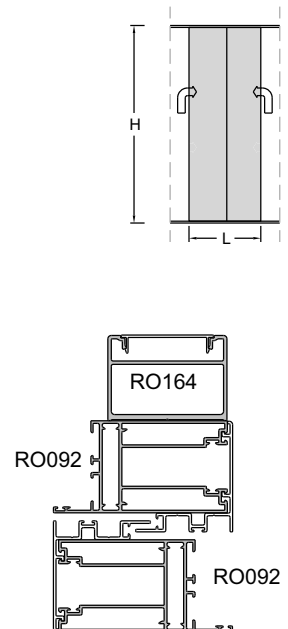
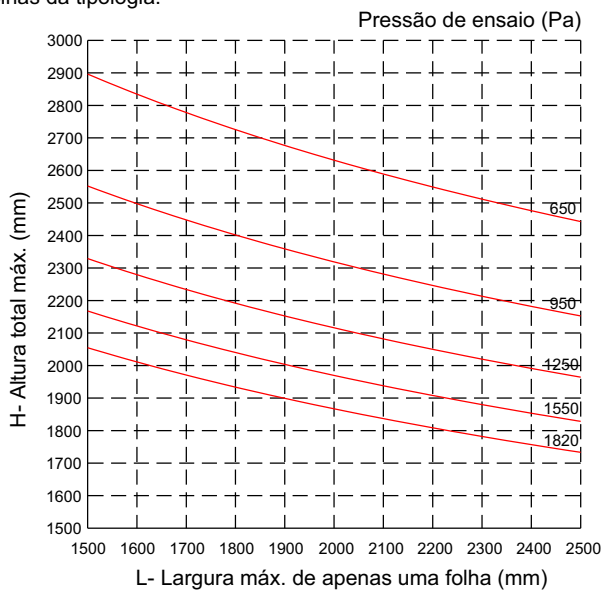

RO092	RO092	RO164
Área = 757 mm ²	Área = 757 mm ²	Área = 579 mm ²
Jx = 299713 mm ⁴	Jx = 299713 mm ⁴	Jx = 171680 mm ⁴
Wx = 10553 mm ³	Wx = 10553 mm ³	Wx = 5911 mm ³
Jx total = 771106 mm⁴		

Tensão admissível = 7 kg/mm² (liga 6060-T5)

Flecha admissível = H / 175

Janela e porta de correr - 2, 3 e 4 planos

Notas:

A largura do gráfico refere-se a apenas uma folha, ou seja, para obter a largura total da esquadria deve-se multiplicar a medida máxima encontrada no gráfico pela quantidade de folhas da tipologia.

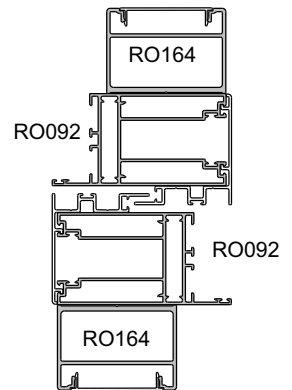
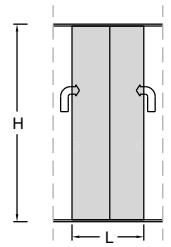
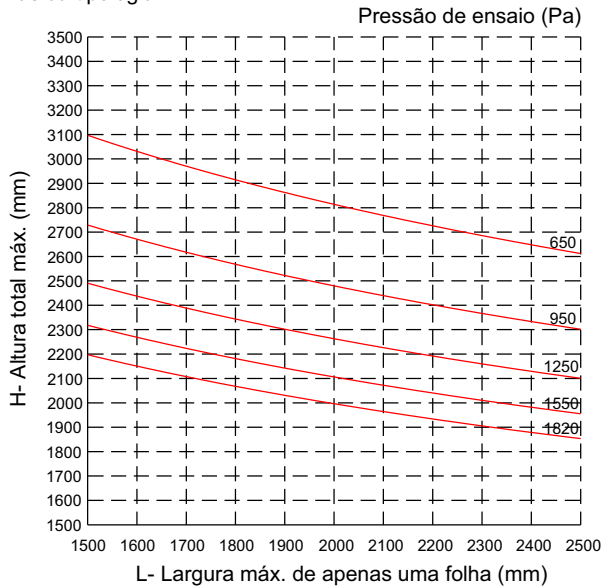

RO092	RO092	RO164	RO164
Área = 757 mm ²	Área = 757 mm ²	Área = 579 mm ²	Área = 579 mm ²
Jx = 299713 mm ⁴	Jx = 299713 mm ⁴	Jx = 171680 mm ⁴	Jx = 171680 mm ⁴
Wx = 10553 mm ³	Wx = 10553 mm ³	Wx = 5911 mm ³	Wx = 5911 mm ³
Jx total = 942786 mm⁴			

Tensão admissível = 7 kg/mm² (liga 6060-T5)

Flecha admissível = H / 175

Janela e porta de correr - 2, 3 e 4 planos

Notas:

A largura do gráfico refere-se a apenas uma folha, ou seja, para obter a largura total da esquadria deve-se multiplicar a medida máxima encontrada no gráfico pela quantidade de folhas da tipologia.

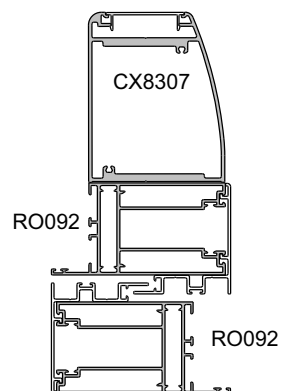
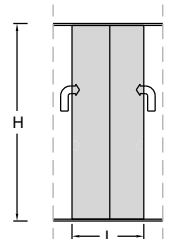
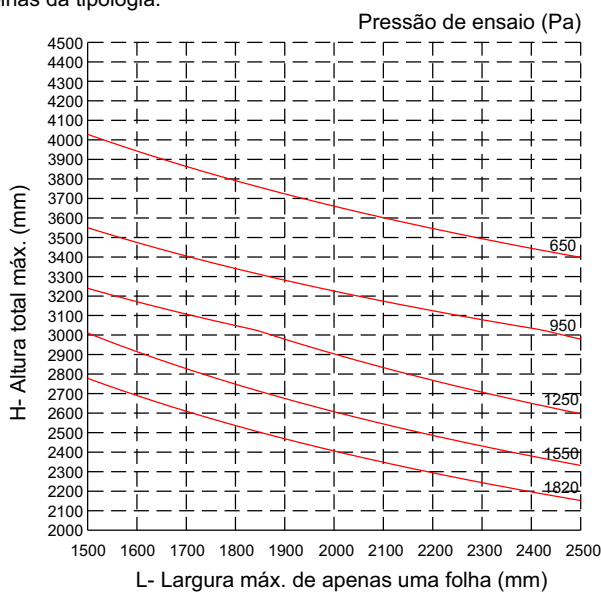

RO092	RO092	CX8307
Área = 757 mm ²	Área = 757 mm ²	Área = 1078 mm ²
Jx = 299713 mm ⁴	Jx = 299713 mm ⁴	Jx = 1476021 mm ⁴
Wx = 10553 mm ³	Wx = 10553 mm ³	Wx = 28098 mm ³
Jx total = 2075447 mm⁴		

Tensão admissível = 7 kg/mm² (liga 6060-T5)

Flecha admissível = H / 175

Janela e porta de correr - 2, 3 e 4 planos

Notas:

A largura do gráfico refere-se a apenas uma folha, ou seja, para obter a largura total da esquadria deve-se multiplicar a medida máxima encontrada no gráfico pela quantidade de folhas da tipologia.

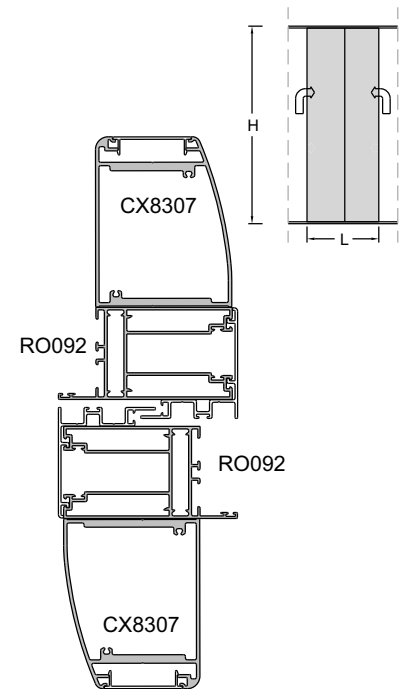
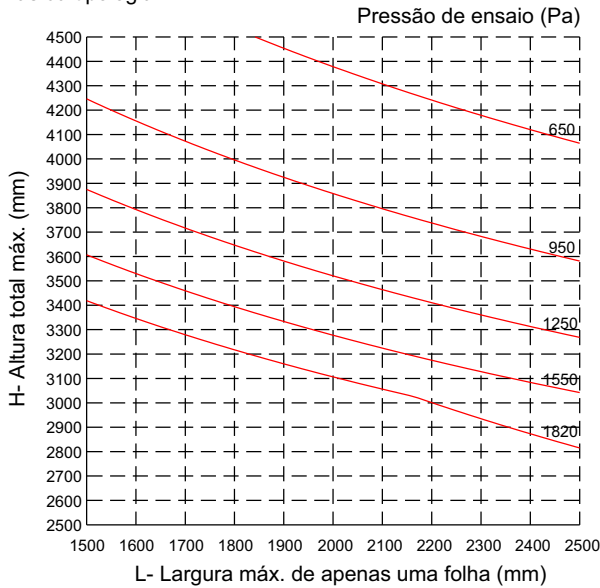

RO092	RO092	CX8307	CX8307
Área = 757 mm ²	Área = 757 mm ²	Área = 1078 mm ²	Área = 1078 mm ²
Jx = 299713 mm ⁴	Jx = 299713 mm ⁴	Jx = 1476021 mm ⁴	Jx = 1476021 mm ⁴
Wx = 10553 mm ³	Wx = 10553 mm ³	Wx = 28098 mm ³	Wx = 28098 mm ³
Jx total = 3551468 mm⁴			

Tensão admissível = 7 kg/mm² (liga 6060-T5)

Flecha admissível = H / 175

Janela e porta de correr - 2, 3 e 4 planos

Notas:

A largura do gráfico refere-se a apenas uma folha, ou seja, para obter a largura total da esquadria deve-se multiplicar a medida máxima encontrada no gráfico pela quantidade de folhas da tipologia.

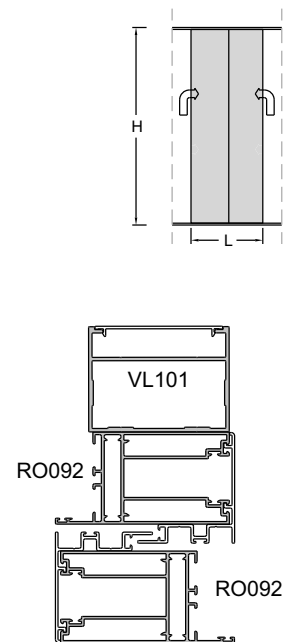
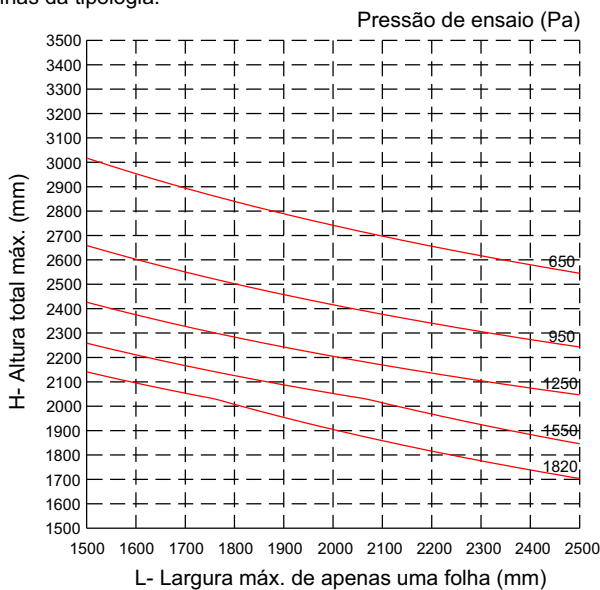

RO092	RO092	VL101
Área = 757 mm ²	Área = 757 mm ²	Área = 633 mm ²
Jx = 299713 mm ⁴	Jx = 299713 mm ⁴	Jx = 272661 mm ⁴
Wx = 10553 mm ³	Wx = 10553 mm ³	Wx = 7741 mm ³
Jx total = 872087 mm⁴		

Tensão admissível = 7 kg/mm² (liga 6060-T5)

Flecha admissível = H / 175

Janela e porta de correr - 2, 3 e 4 planos

Notas:

A largura do gráfico refere-se a apenas uma folha, ou seja, para obter a largura total da esquadria deve-se multiplicar a medida máxima encontrada no gráfico pela quantidade de folhas da tipologia.

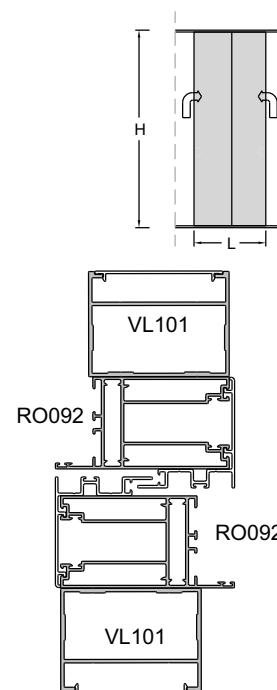
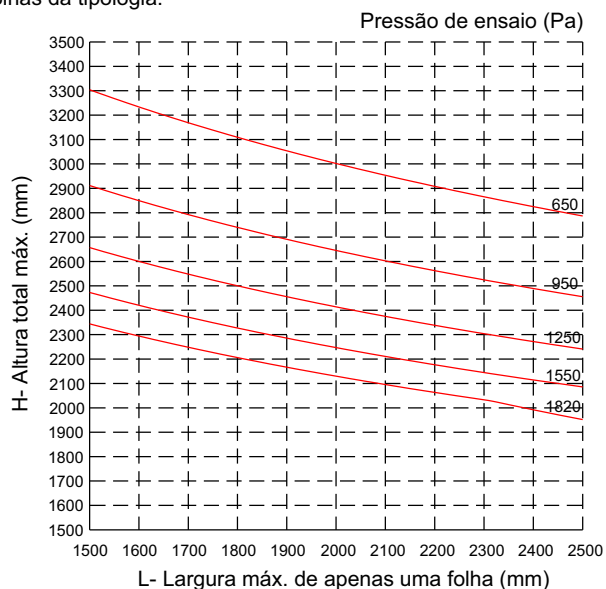

RO092	RO092	VL101	VL101
Área = 757 mm ²	Área = 757 mm ²	Área = 633 mm ²	Área = 633 mm ²
Jx = 299713 mm ⁴	Jx = 299713 mm ⁴	Jx = 272661 mm ⁴	Jx = 272661 mm ⁴
Wx = 10553 mm ³	Wx = 10553 mm ³	Wx = 7741 mm ³	Wx = 7741 mm ³
Jx total = 1144748 mm⁴			

Tensão admissível = 7 kg/mm² (liga 6060-T5)

Flecha admissível = H / 175

Janela e porta de correr - 2, 3 e 4 planos

Notas:

A largura do gráfico refere-se a apenas uma folha, ou seja, para obter a largura total da esquadria deve-se multiplicar a medida máxima encontrada no gráfico pela quantidade de folhas da tipologia.

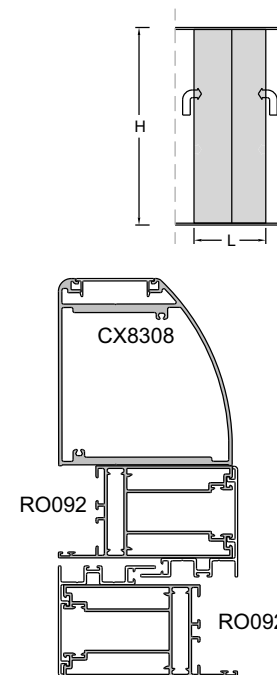
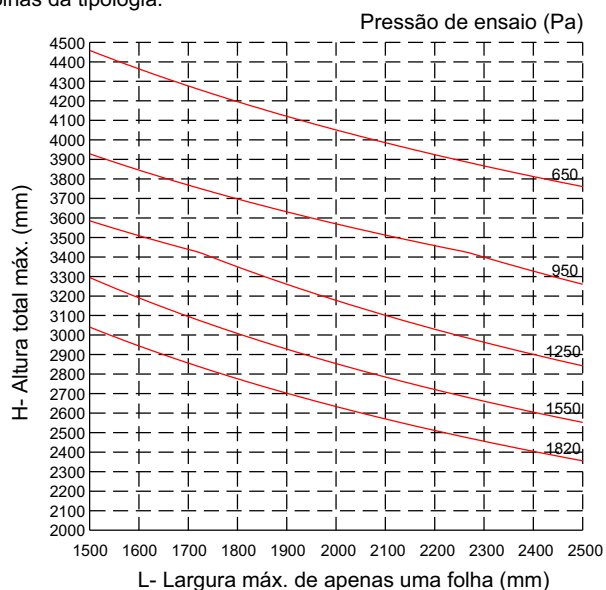

RO092	RO092	CX8308
Área = 757 mm ²	Área = 757 mm ²	Área = 1272 mm ²
Jx = 299713 mm ⁴	Jx = 299713 mm ⁴	Jx = 2214125 mm ⁴
Wx = 10553 mm ³	Wx = 10553 mm ³	Wx = 37249 mm ³
Jx total = 2813551 mm⁴		

Tensão admissível = 7 kg/mm² (liga 6060-T5)

Flecha admissível = H / 175

Janela e porta de correr - 2, 3 e 4 planos

Notas:

A largura do gráfico refere-se a apenas uma folha, ou seja, para obter a largura total da esquadria deve-se multiplicar a medida máxima encontrada no gráfico pela quantidade de folhas da tipologia.

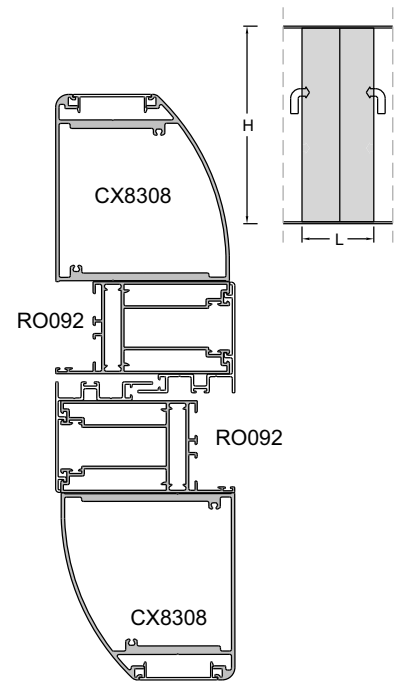
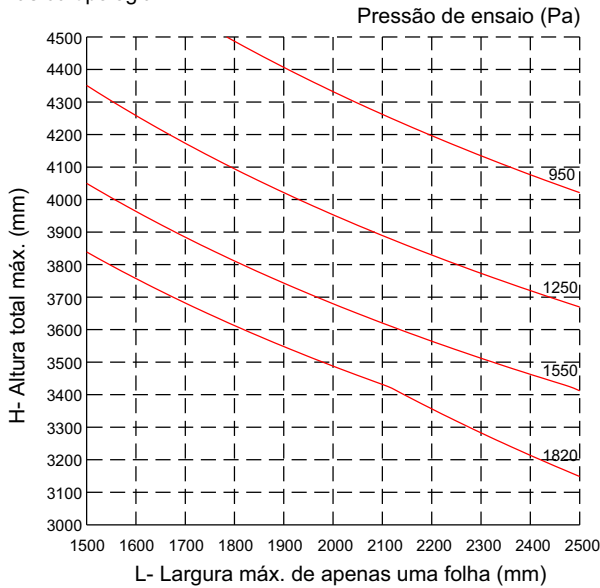

RO092	RO092	CX8308	CX8308
Área = 757 mm ²	Área = 757 mm ²	Área = 1272 mm ²	Área = 1272 mm ²
Jx = 299713 mm ⁴	Jx = 299713 mm ⁴	Jx = 2214125 mm ⁴	Jx = 2214125 mm ⁴
Wx = 10553 mm ³	Wx = 10553 mm ³	Wx = 37249 mm ³	Wx = 37249 mm ³
Jx total = 5027676 mm⁴			

Tensão admissível = 7 kg/mm² (liga 6060-T5)

Flecha admissível = H / 175

Porta de correr - 2 e 3 planos com encontro central

Notas:

A largura do gráfico refere-se a apenas uma folha, ou seja, para obter a largura total da esquadria deve-se multiplicar a medida máxima encontrada no gráfico pela quantidade de folhas da tipologia.

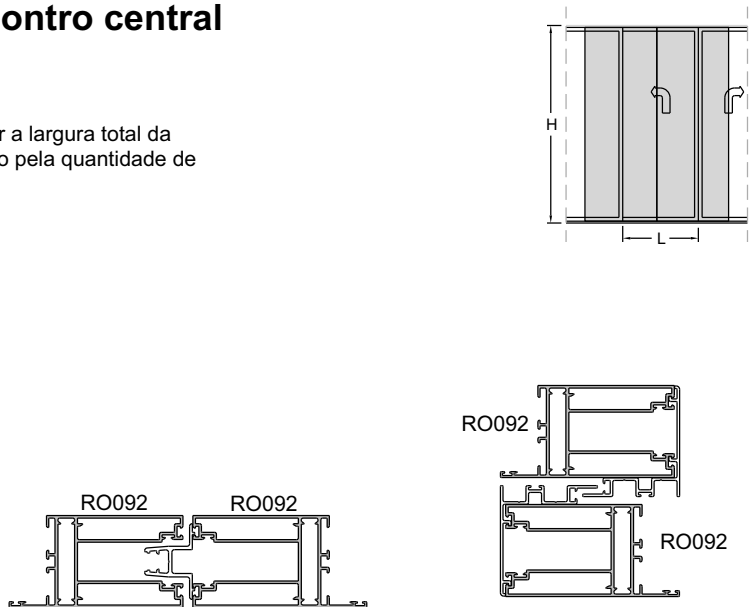
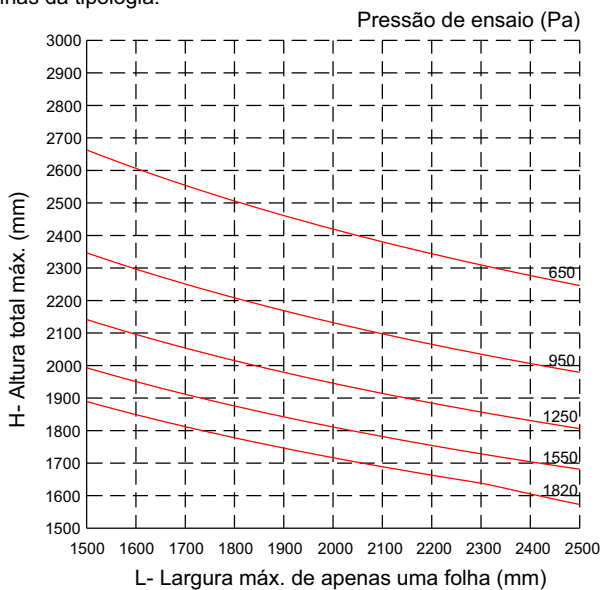

RO092	RO092	RO092	RO092
Área = 757 mm ²	Área = 757 mm ²	Área = 757 mm ²	Área = 757 mm ²
Jx = 299713 mm ⁴	Jx = 299713 mm ⁴	Jx = 299713 mm ⁴	Jx = 299713 mm ⁴
Wx = 10553 mm ³	Wx = 10553 mm ³	Wx = 10553 mm ³	Wx = 10553 mm ³
Jx total = 599426 mm⁴		Jx total = 599426 mm⁴	

Tensão admissível = 7 kg/mm² (liga 6060-T5)

Flecha admissível = H / 175

Porta de correr - 2 e 3 planos com encontro central

Notas:

A largura do gráfico refere-se a apenas uma folha, ou seja, para obter a largura total da esquadria deve-se multiplicar a medida máxima encontrada no gráfico pela quantidade de folhas da tipologia.

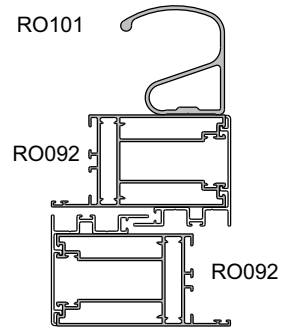
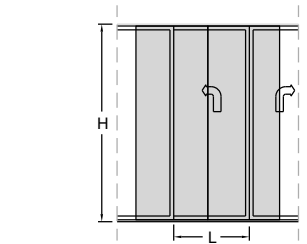
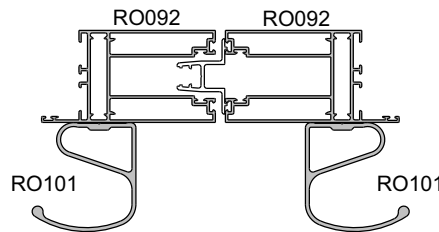
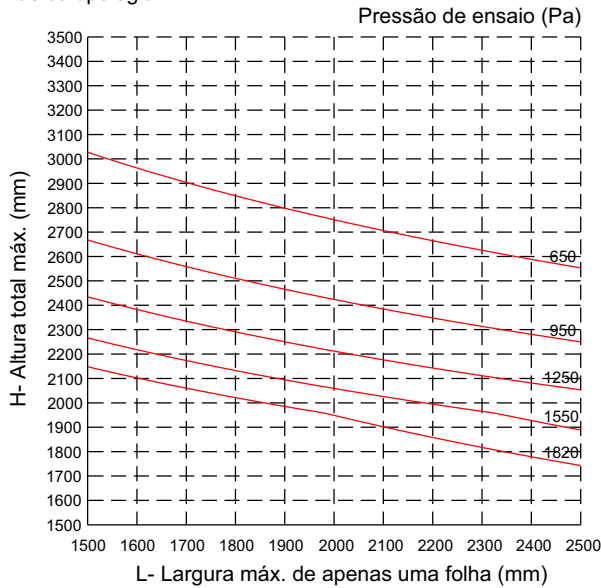

RO092 (2x)	RO101 (2x)
Área = 1514 mm ²	Área = 1100 mm ²
Jx = 599426 mm ⁴	Jx = 562518 mm ⁴
Wx = 21106 mm ³	Wx = 16554 mm ³
Jx total = 1161944 mm⁴	

RO092 (2x)	RO101 (1x)
Área = 1514 mm ²	Área = 550 mm ²
Jx = 599426 mm ⁴	Jx = 281259 mm ⁴
Wx = 21106 mm ³	Wx = 8277 mm ³
Jx total = 880685 mm⁴	

Tensão admissível = 7 kg/mm² (liga 6060-T5)

Flecha admissível = H / 175

Porta de correr - 2 e 3 planos com encontro central

Notas:

A largura do gráfico refere-se a apenas uma folha, ou seja, para obter a largura total da esquadria deve-se multiplicar a medida máxima encontrada no gráfico pela quantidade de folhas da tipologia.

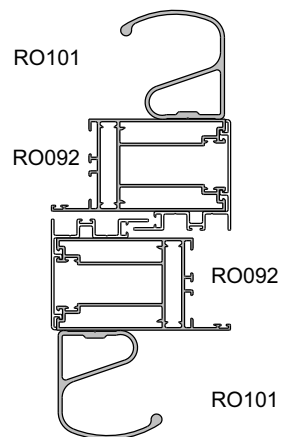
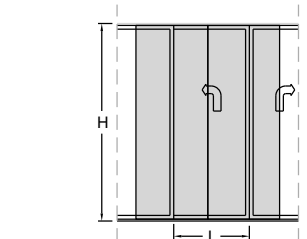
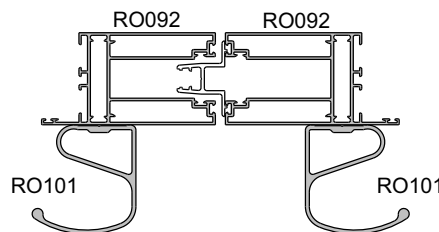
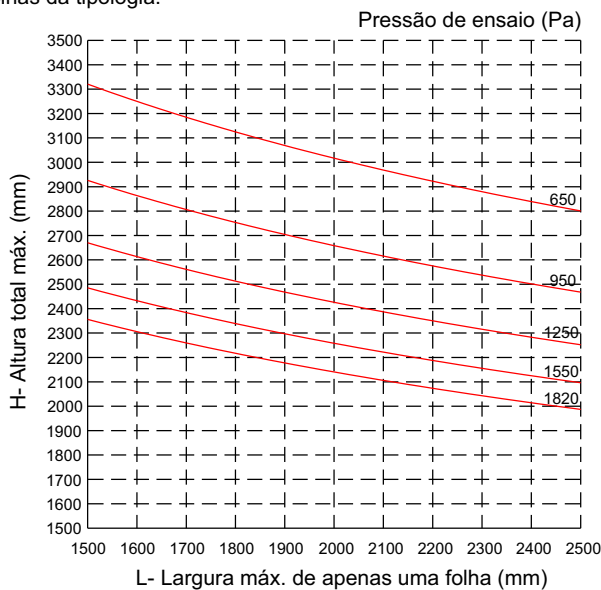

RO092 (2x)	RO101 (2x)
Área = 1514 mm ²	Área = 1100 mm ²
Jx = 599426 mm ⁴	Jx = 562518 mm ⁴
Wx = 21106 mm ³	Wx = 16554 mm ³
Jx total = 1161944 mm⁴	

RO092 (2x)	RO101 (2x)
Área = 1514 mm ²	Área = 1100 mm ²
Jx = 599426 mm ⁴	Jx = 562518 mm ⁴
Wx = 21106 mm ³	Wx = 16554 mm ³
Jx total = 1161944 mm⁴	

Tensão admissível = 7 kg/mm² (liga 6060-T5)

Flecha admissível = H / 175

Porta de correr - 2 e 3 planos com encontro central

Notas:

A largura do gráfico refere-se a apenas uma folha, ou seja, para obter a largura total da esquadria deve-se multiplicar a medida máxima encontrada no gráfico pela quantidade de folhas da tipologia.

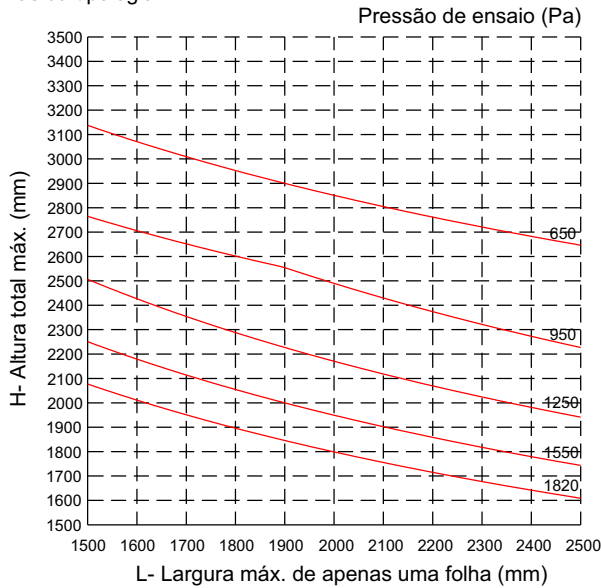

Tensão admissível = 7 kg/mm² (liga 6060-T5)

Flecha admissível = H / 175

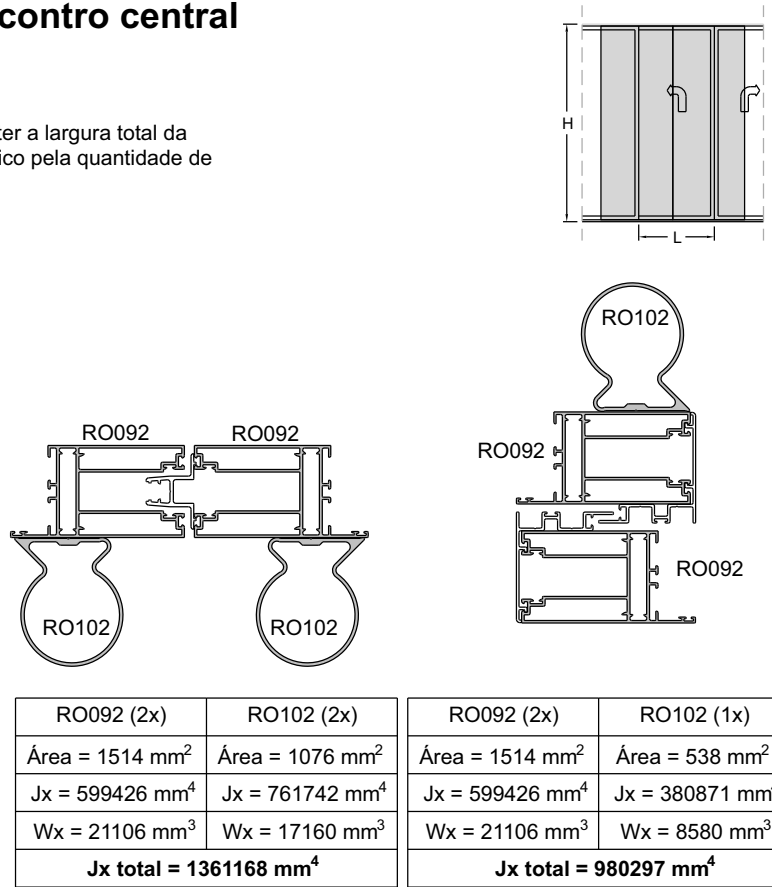

Porta de correr - 2 e 3 planos com encontro central

Notas:

A largura do gráfico refere-se a apenas uma folha, ou seja, para obter a largura total da esquadria deve-se multiplicar a medida máxima encontrada no gráfico pela quantidade de folhas da tipologia.

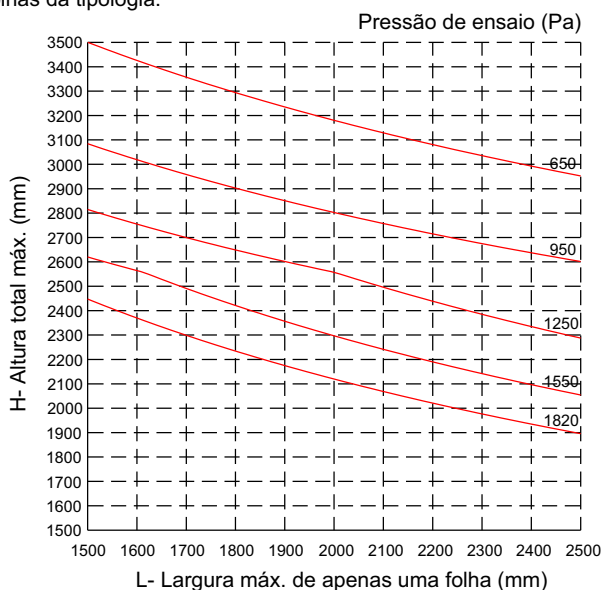

Tensão admissível = 7 kg/mm² (liga 6060-T5)

Flecha admissível = H / 175

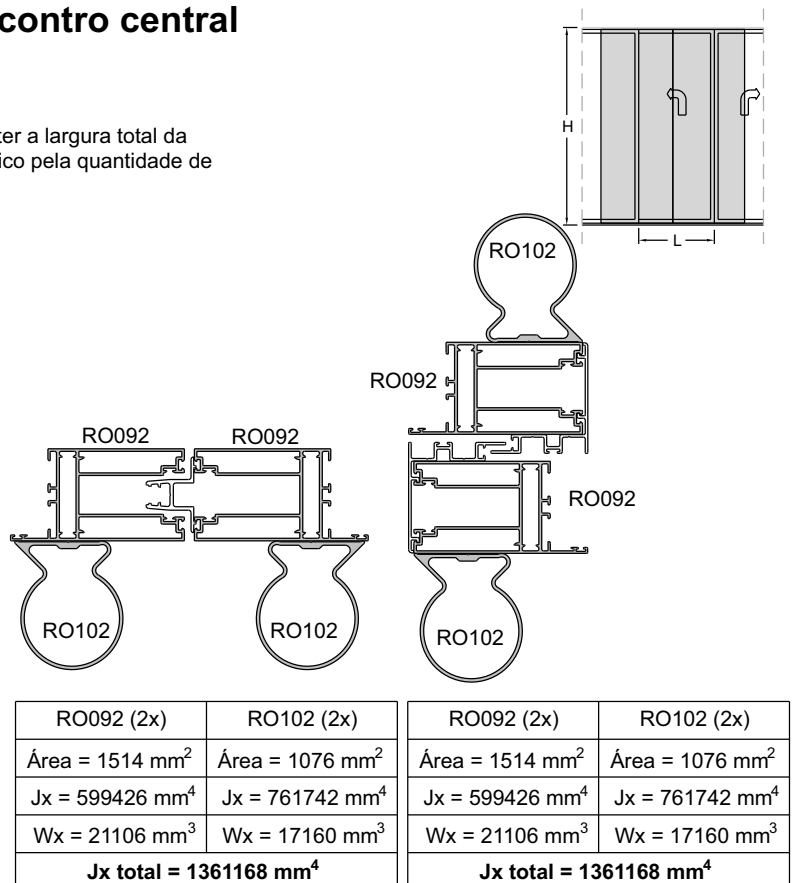

Porta de correr - 2 e 3 planos com encontro central

Notas:

A largura do gráfico refere-se a apenas uma folha, ou seja, para obter a largura total da esquadria deve-se multiplicar a medida máxima encontrada no gráfico pela quantidade de folhas da tipologia.

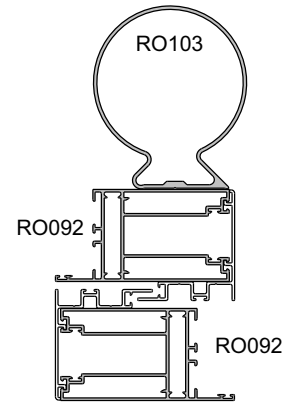
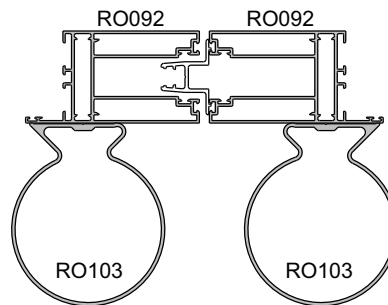
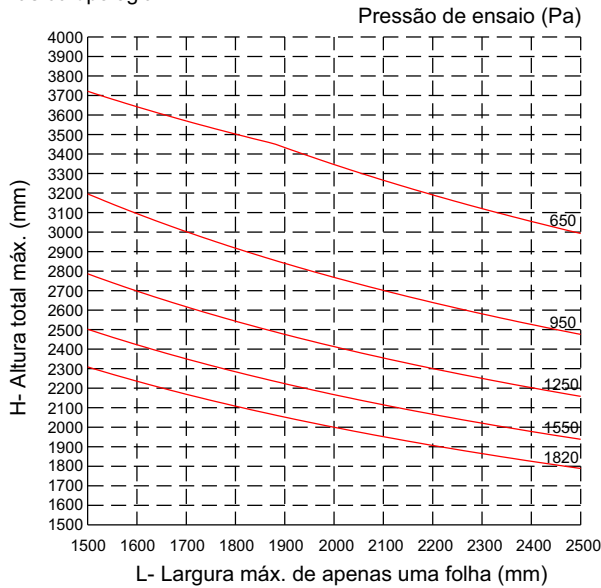

RO092 (2x)	RO103 (2x)	RO092 (2x)	RO103 (1x)
Área = 1514 mm ²	Área = 1458 mm ²	Área = 1514 mm ²	Área = 729 mm ²
Jx = 599426 mm ⁴	Jx = 2073292 mm ⁴	Jx = 599426 mm ⁴	Jx = 1036646 mm ⁴
Wx = 21106 mm ³	Wx = 21816 mm ³	Wx = 21106 mm ³	Wx = 10908 mm ³
Jx total = 2672718 mm⁴		Jx total = 1636072 mm⁴	

Tensão admissível = 7 kg/mm² (liga 6060-T5)

Flecha admissível = H / 175

Porta de correr - 2 e 3 planos com encontro central

Notas:

A largura do gráfico refere-se a apenas uma folha, ou seja, para obter a largura total da esquadria deve-se multiplicar a medida máxima encontrada no gráfico pela quantidade de folhas da tipologia.

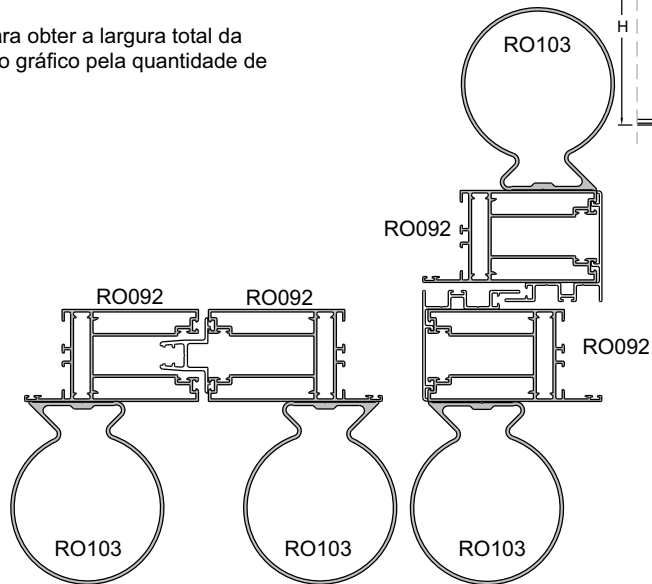
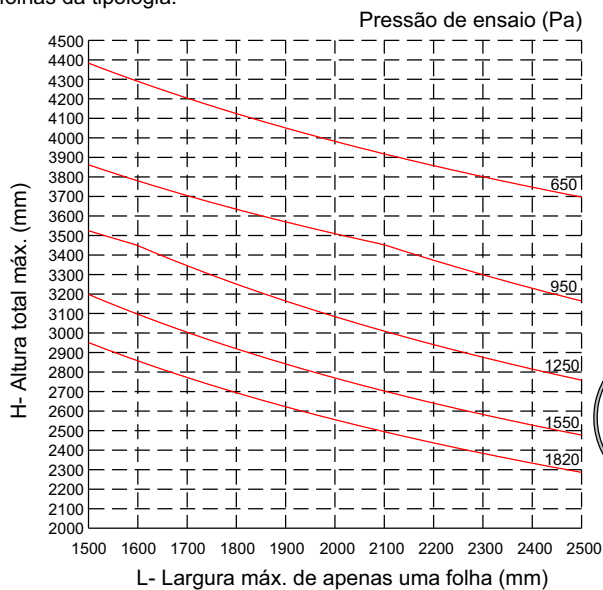

RO092 (2x)	RO103 (2x)	RO092 (2x)	RO103 (2x)
Área = 1514 mm ²	Área = 1458 mm ²	Área = 1514 mm ²	Área = 1458 mm ²
Jx = 599426 mm ⁴	Jx = 2073292 mm ⁴	Jx = 599426 mm ⁴	Jx = 2073292 mm ⁴
Wx = 21106 mm ³	Wx = 21816 mm ³	Wx = 21106 mm ³	Wx = 21816 mm ³
Jx total = 2672718 mm⁴		Jx total = 2672718 mm⁴	

Tensão admissível = 7 kg/mm² (liga 6060-T5)

Flecha admissível = H / 175

Porta de correr - 2 e 3 planos com encontro central

Notas:

A largura do gráfico refere-se a apenas uma folha, ou seja, para obter a largura total da esquadria deve-se multiplicar a medida máxima encontrada no gráfico pela quantidade de folhas da tipologia.

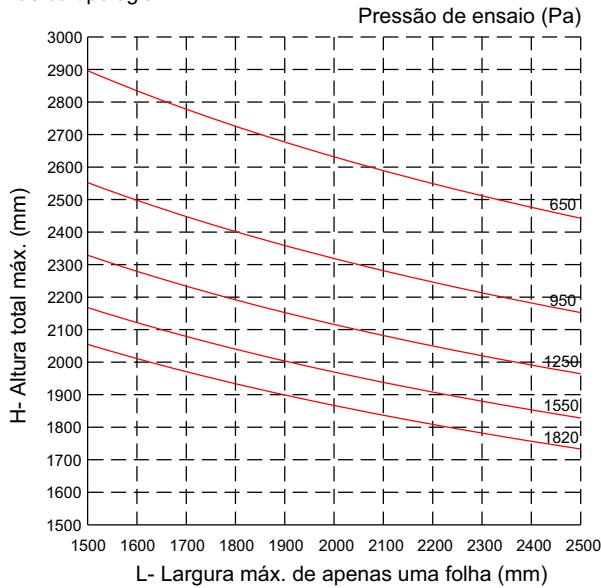

Tensão admissível = 7 kg/mm² (liga 6060-T5)

Flecha admissível = H / 175

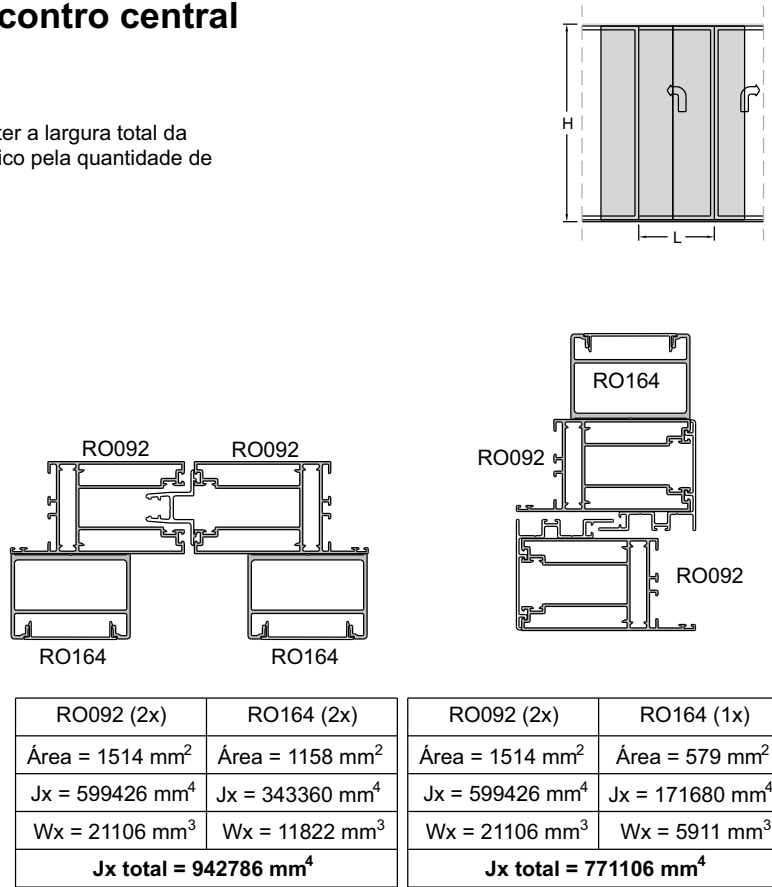

Porta de correr - 2 e 3 planos com encontro central

Notas:

A largura do gráfico refere-se a apenas uma folha, ou seja, para obter a largura total da esquadria deve-se multiplicar a medida máxima encontrada no gráfico pela quantidade de folhas da tipologia.

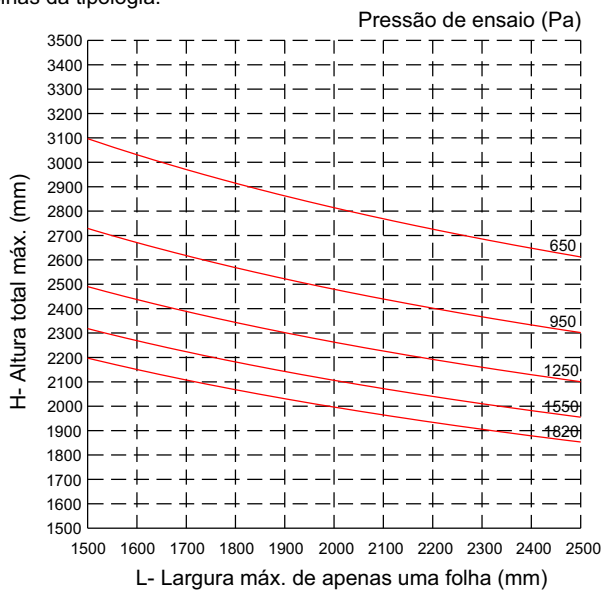

Tensão admissível = 7 kg/mm² (liga 6060-T5)

Flecha admissível = H / 175

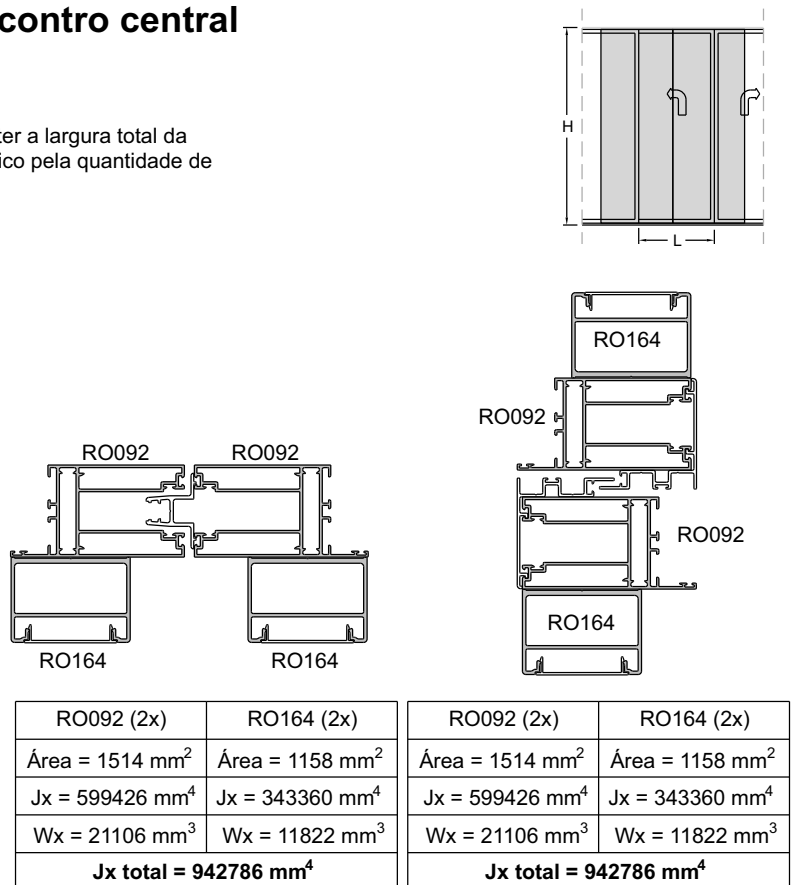

Porta de correr - 2 e 3 planos com encontro central

Notas:

A largura do gráfico refere-se a apenas uma folha, ou seja, para obter a largura total da esquadria deve-se multiplicar a medida máxima encontrada no gráfico pela quantidade de folhas da tipologia.

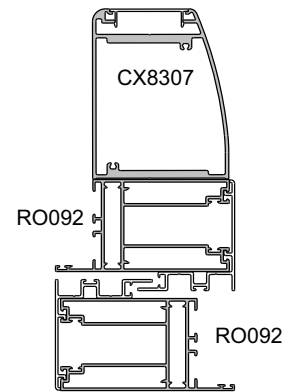
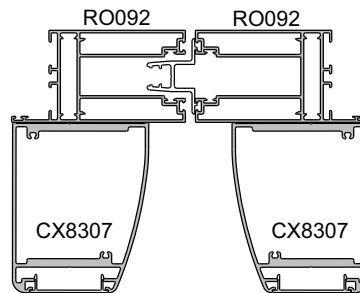
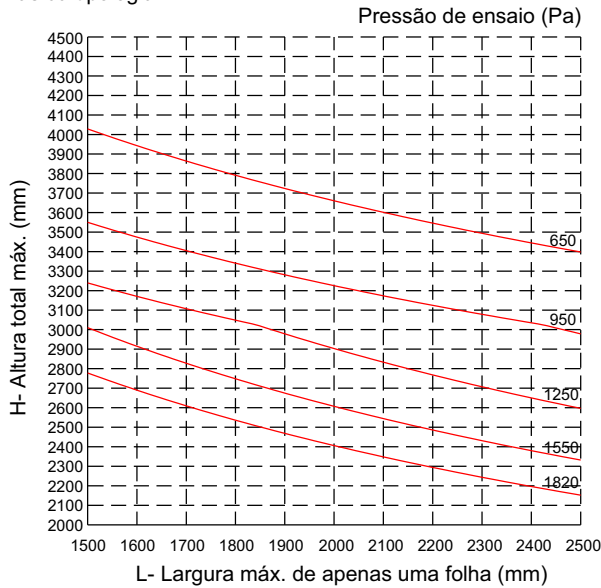

RO092 (2x)	CX8307 (2x)	RO092 (2x)	CX8307 (1x)
Área = 1514 mm ²	Área = 2156 mm ²	Área = 1514 mm ²	Área = 1078 mm ²
Jx = 599426 mm ⁴	Jx = 2952042 mm ⁴	Jx = 599426 mm ⁴	Jx = 1476021 mm ⁴
Wx = 21106 mm ³	Wx = 56196 mm ³	Wx = 21106 mm ³	Wx = 28098 mm ³
Jx total = 3551468 mm⁴		Jx total = 2075447 mm⁴	

Tensão admissível = 7 kg/mm² (liga 6060-T5)

Flecha admissível = H / 175

Porta de correr - 2 e 3 planos com encontro central

Notas:

A largura do gráfico refere-se a apenas uma folha, ou seja, para obter a largura total da esquadria deve-se multiplicar a medida máxima encontrada no gráfico pela quantidade de folhas da tipologia.

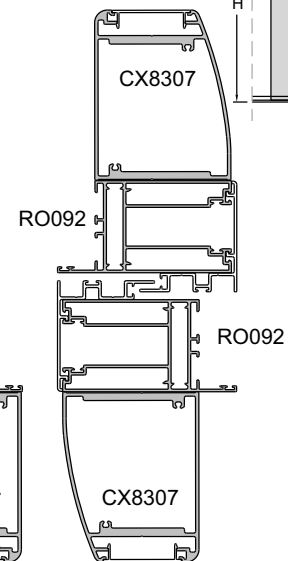
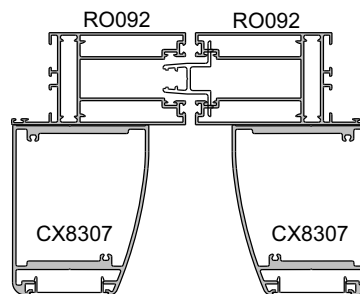
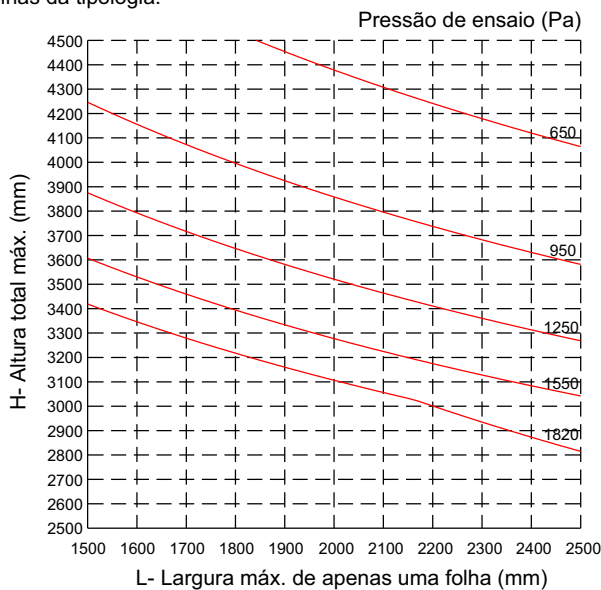

RO092 (2x)	CX8307 (2x)	RO092 (2x)	CX8307 (2x)
Área = 1514 mm ²	Área = 2156 mm ²	Área = 1514 mm ²	Área = 2156 mm ²
Jx = 599426 mm ⁴	Jx = 2952042 mm ⁴	Jx = 599426 mm ⁴	Jx = 2952042 mm ⁴
Wx = 21106 mm ³	Wx = 56196 mm ³	Wx = 21106 mm ³	Wx = 56196 mm ³
Jx total = 3551468 mm⁴		Jx total = 3551468 mm⁴	

Tensão admissível = 7 kg/mm² (liga 6060-T5)

Flecha admissível = H / 175

Porta de correr - 2 e 3 planos com encontro central

Notas:

A largura do gráfico refere-se a apenas uma folha, ou seja, para obter a largura total da esquadria deve-se multiplicar a medida máxima encontrada no gráfico pela quantidade de folhas da tipologia.

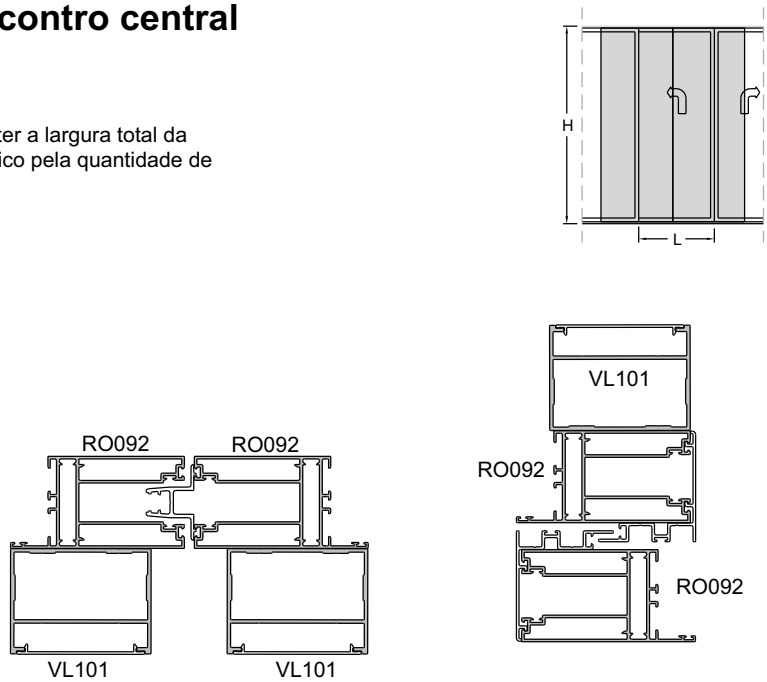
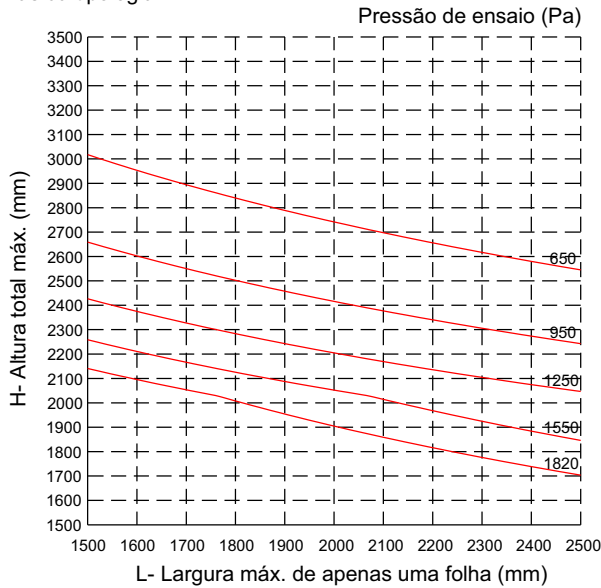

RO092 (2x)	VL101 (2x)
Área = 1514 mm ²	Área = 1266 mm ²
Jx = 599426 mm ⁴	Jx = 545322 mm ⁴
Wx = 21106 mm ³	Wx = 15482 mm ³
Jx total = 1144748 mm⁴	

RO092 (2x)	VL101 (1x)
Área = 1514 mm ²	Área = 633 mm ²
Jx = 599426 mm ⁴	Jx = 272661 mm ⁴
Wx = 21106 mm ³	Wx = 7741 mm ³
Jx total = 872087 mm⁴	

Tensão admissível = 7 kg/mm² (liga 6060-T5)

Flecha admissível = H / 175

Porta de correr - 2 e 3 planos com encontro central

Notas:

A largura do gráfico refere-se a apenas uma folha, ou seja, para obter a largura total da esquadria deve-se multiplicar a medida máxima encontrada no gráfico pela quantidade de folhas da tipologia.

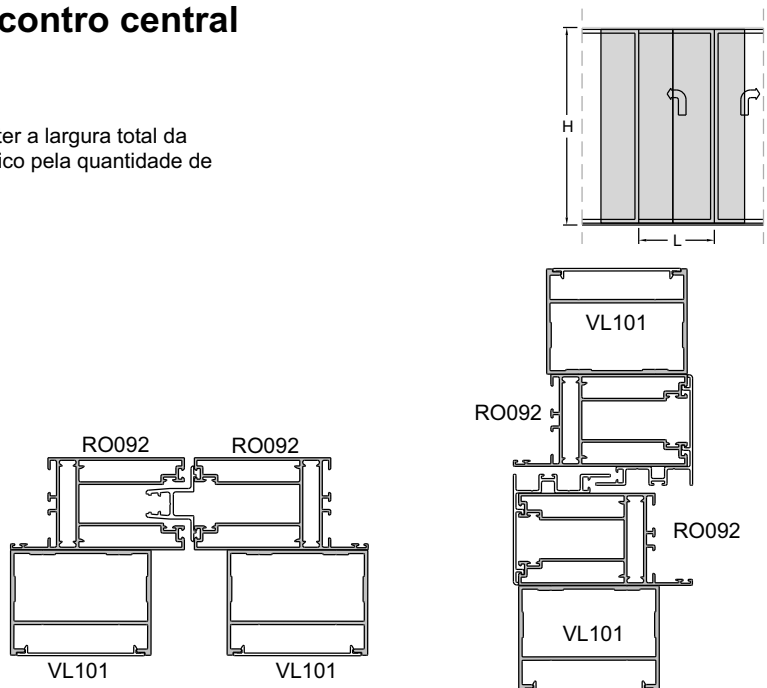
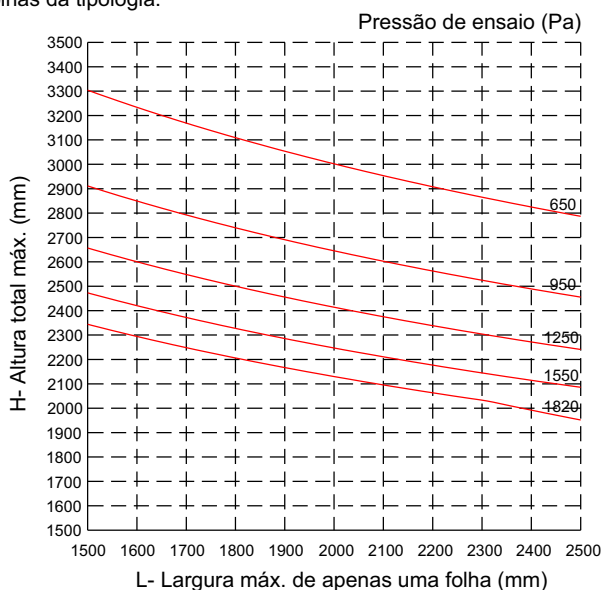

RO092 (2x)	VL101 (2x)
Área = 1514 mm ²	Área = 1266 mm ²
Jx = 599426 mm ⁴	Jx = 545322 mm ⁴
Wx = 21106 mm ³	Wx = 15482 mm ³
Jx total = 1144748 mm⁴	

RO092 (2x)	VL101 (2x)
Área = 1514 mm ²	Área = 1266 mm ²
Jx = 599426 mm ⁴	Jx = 545322 mm ⁴
Wx = 21106 mm ³	Wx = 15482 mm ³
Jx total = 1144748 mm⁴	

Tensão admissível = 7 kg/mm² (liga 6060-T5)

Flecha admissível = H / 175

Porta de correr - 2 e 3 planos com encontro central

Notas:

A largura do gráfico refere-se a apenas uma folha, ou seja, para obter a largura total da esquadria deve-se multiplicar a medida máxima encontrada no gráfico pela quantidade de folhas da tipologia.

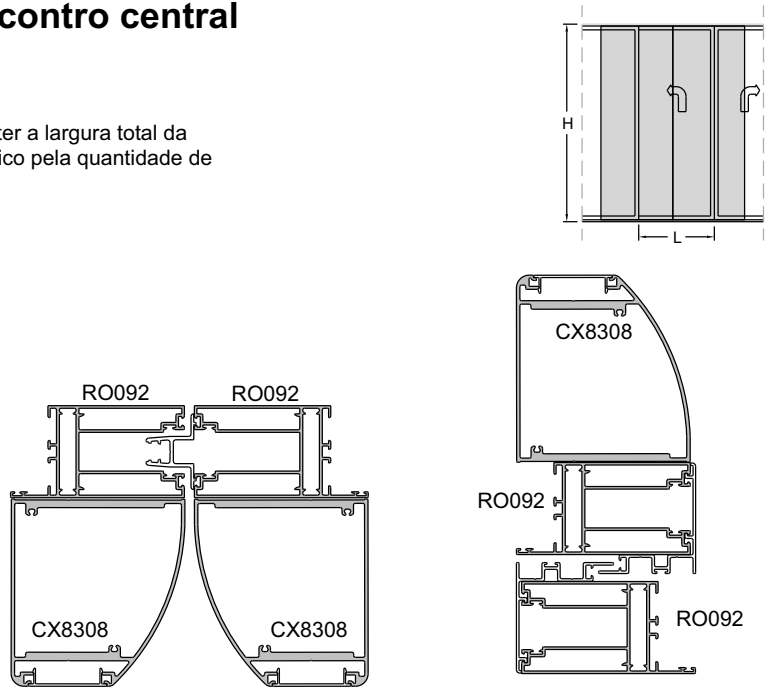
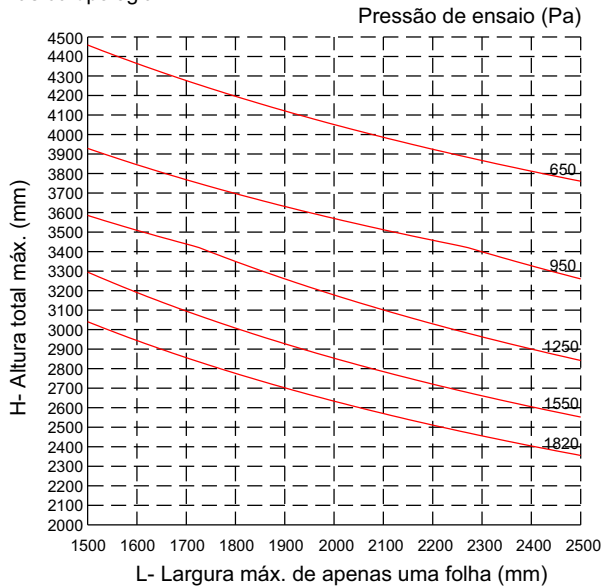

RO092 (2x)	CX8308 (2x)	RO092 (2x)	CX8308 (1x)
Área = 1514 mm ²	Área = 2544 mm ²	Área = 1514 mm ²	Área = 1272 mm ²
Jx = 599426 mm ⁴	Jx = 4428250 mm ⁴	Jx = 599426 mm ⁴	Jx = 2214125 mm ⁴
Wx = 21106 mm ³	Wx = 74498 mm ³	Wx = 21106 mm ³	Wx = 37249 mm ³
Jx total = 5027676 mm⁴		Jx total = 2813551 mm⁴	

Tensão admissível = 7 kg/mm² (liga 6060-T5)

Flecha admissível = H / 175

Porta de correr - 2 e 3 planos com encontro central

Notas:

A largura do gráfico refere-se a apenas uma folha, ou seja, para obter a largura total da esquadria deve-se multiplicar a medida máxima encontrada no gráfico pela quantidade de folhas da tipologia.

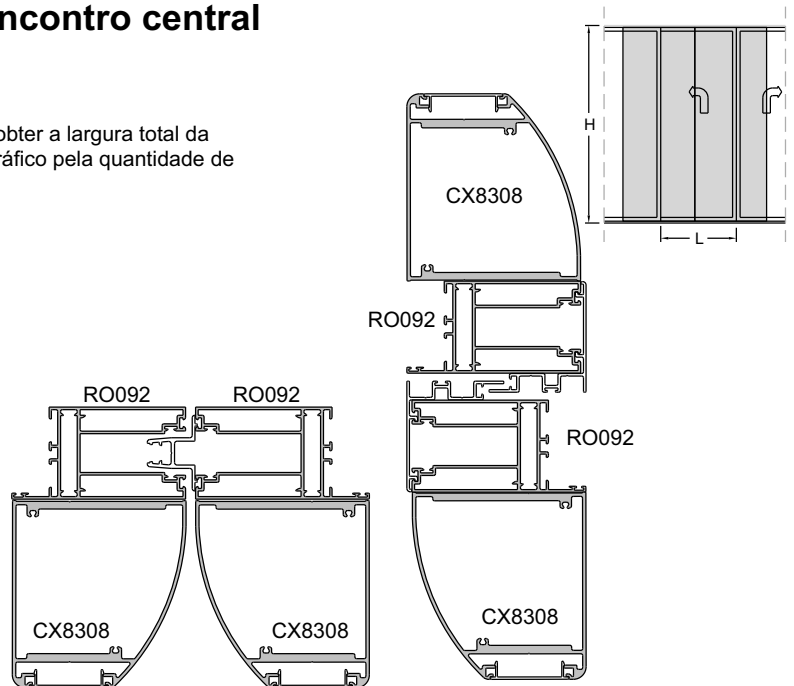
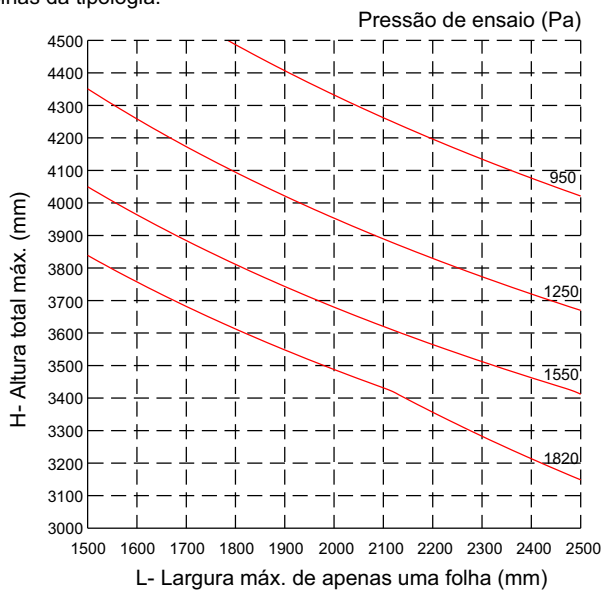

RO092 (2x)	CX8308 (2x)	RO092 (2x)	CX8308 (2x)
Área = 1514 mm ²	Área = 2544 mm ²	Área = 1514 mm ²	Área = 2544 mm ²
Jx = 599426 mm ⁴	Jx = 4428250 mm ⁴	Jx = 599426 mm ⁴	Jx = 4428250 mm ⁴
Wx = 21106 mm ³	Wx = 74498 mm ³	Wx = 21106 mm ³	Wx = 74498 mm ³
Jx total = 5027676 mm⁴		Jx total = 5027676 mm⁴	

Tensão admissível = 7 kg/mm² (liga 6060-T5)

Flecha admissível = H / 175

Janela Oscilo Batente

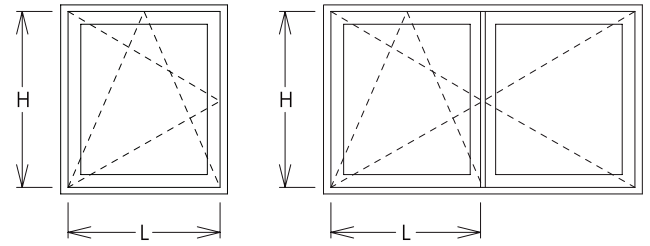
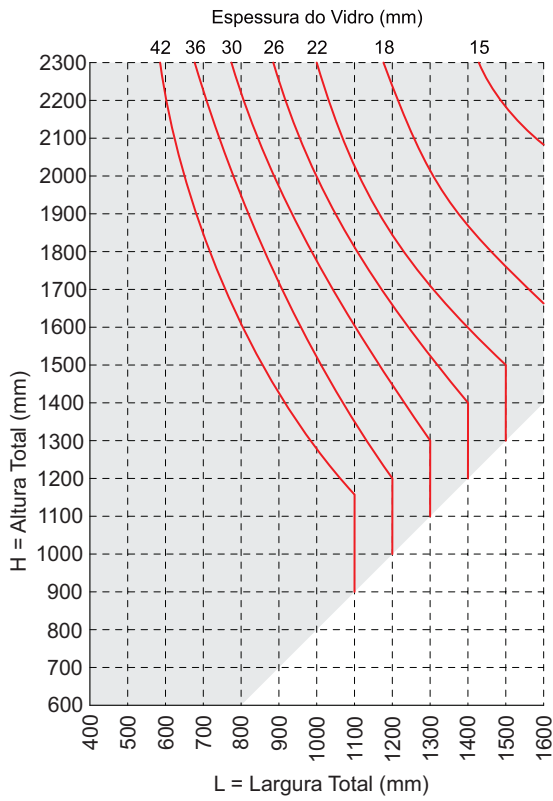

OBS: Tamanhos em função do peso e espessura do vidro

- Peso máximo da Folha = 120kg
- Dimensões permitidas (folha)
 - Dimensões não permitidas

Perfis

RO008 0,886 kg/m

Marco montante e travessa

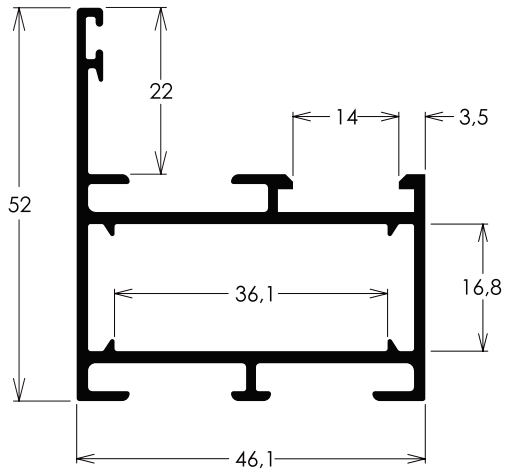

RO013 0,993 kg/m

Marco travessa inferior

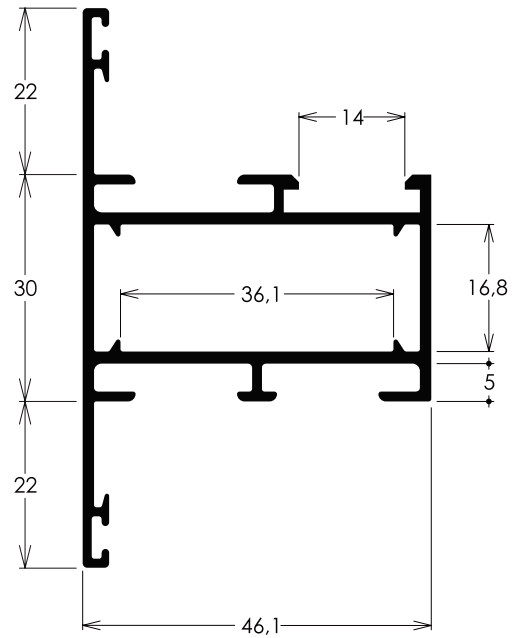

RO011 1,065 kg/m

Mata junta da folha

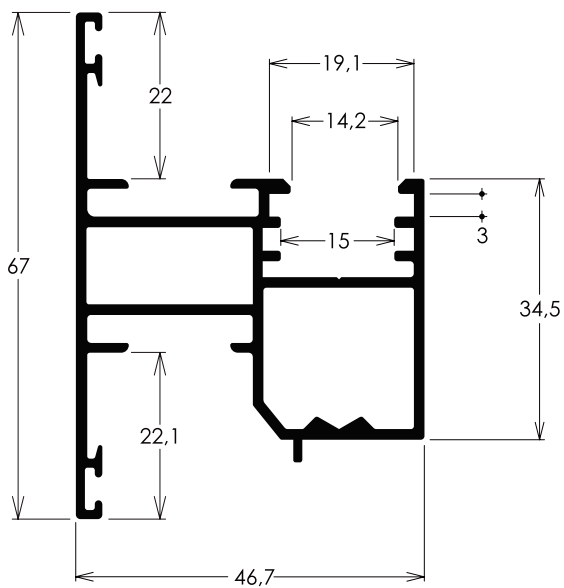

RO010 1,208 kg/m

Folha montante e travessa

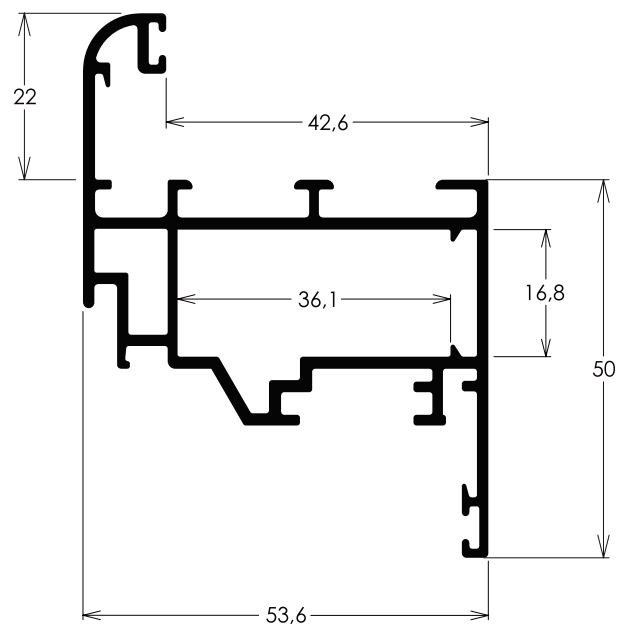

Oscilo batentes

T60

Marco montante e travessa

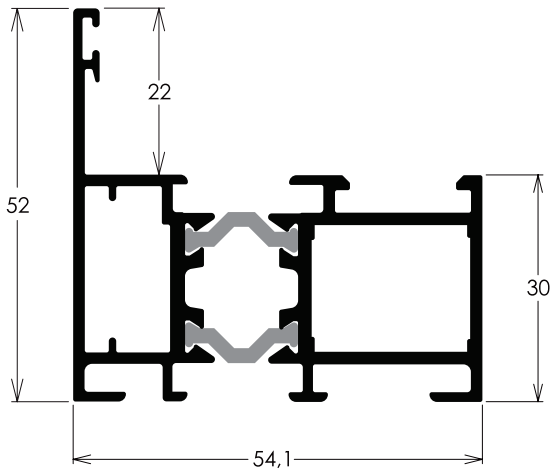

T61

Marco travessa inferior

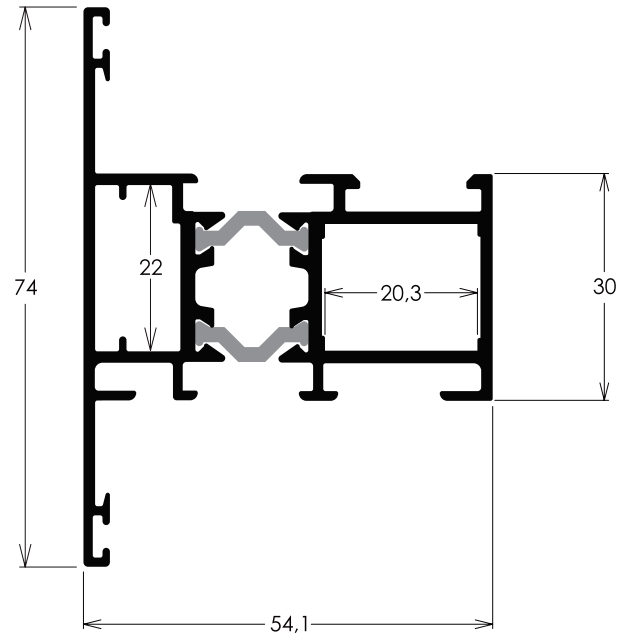

T63

Mata junta da folha

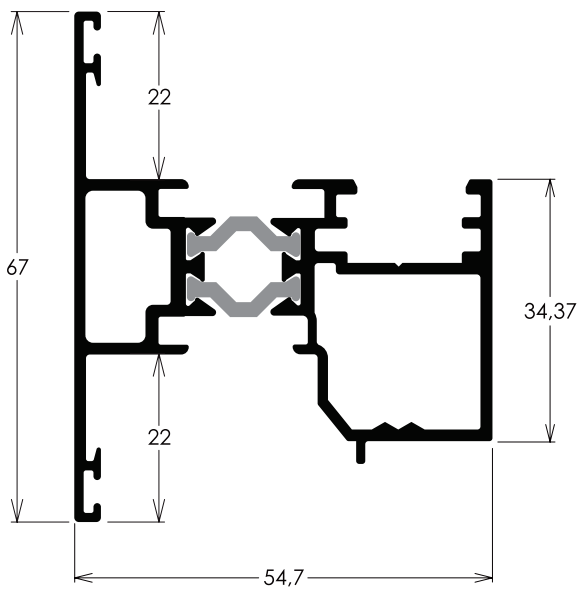

T62

Folha montante e travessa

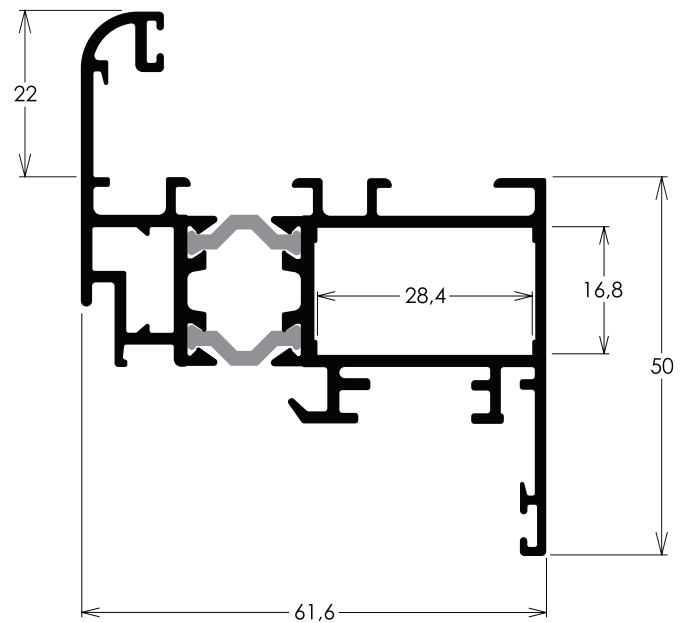

Oscilo batentes

RO082 0,997 kg/m
Marco travessa intermediária

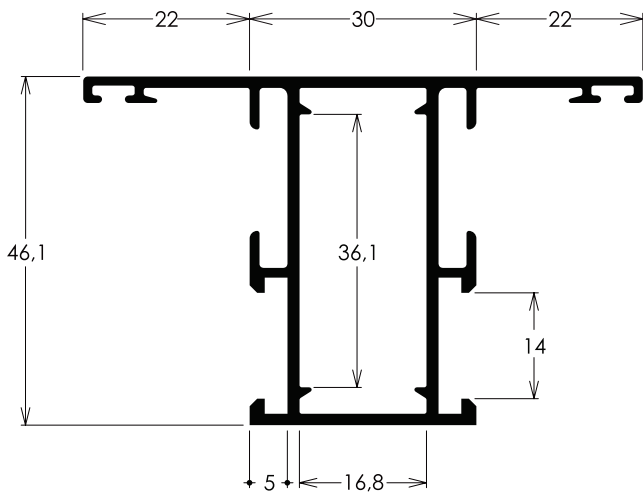

T84
Marco travessa intermediária

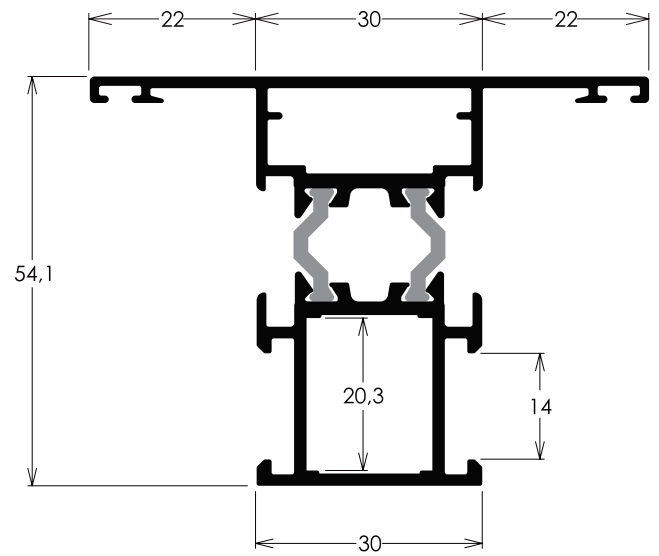

RO081 0,528 kg/m
Inversor

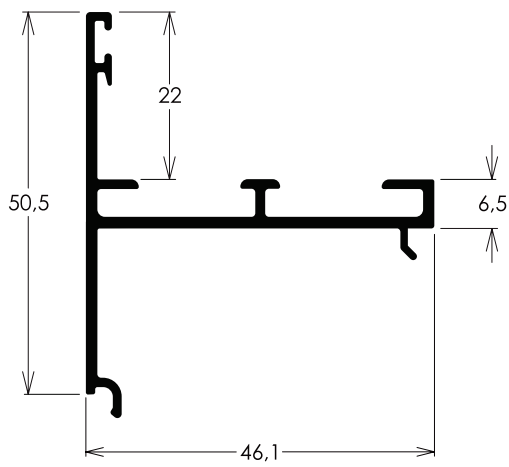

RO014 1,366 kg/m
Marco travessa intermediária

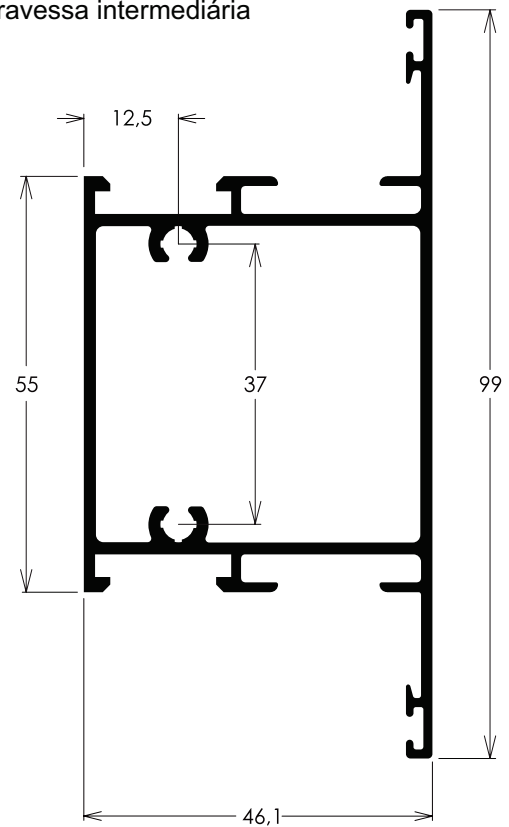

Veneziana orientável

RO097 1,816 kg/m

Folha travessa intermediária

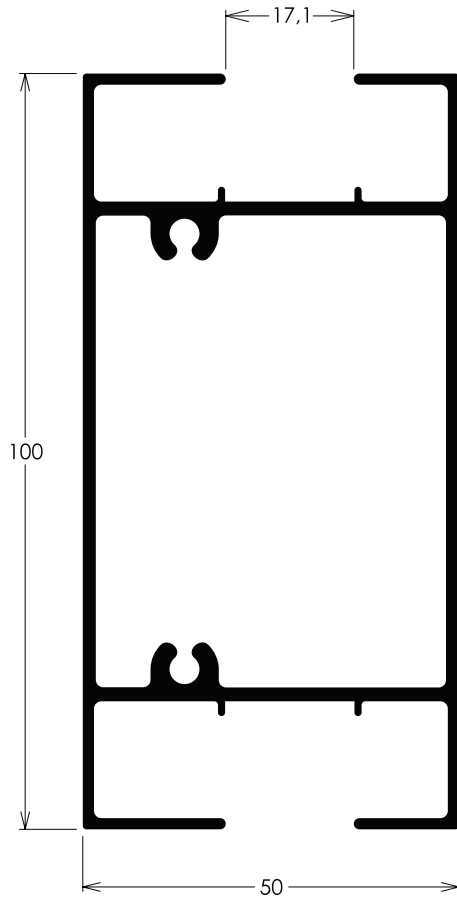

RO096 1,220 kg/m

Folha montante e travessa

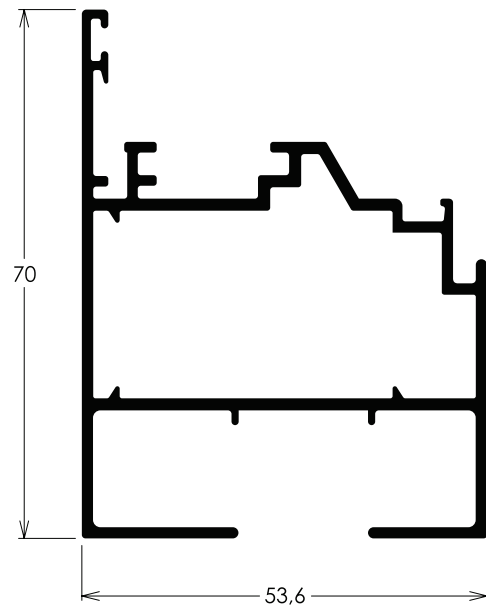

RO098 0,292 kg/m

Terminal da palheta

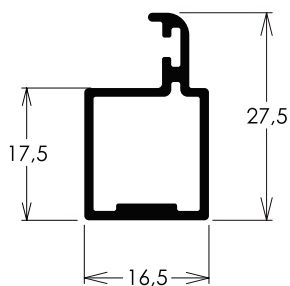

RO099 0,376 kg/m

Palheta veneziana

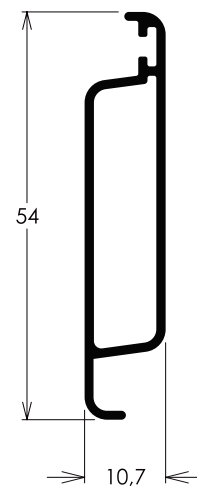

RO077 0,835 kg/m

Marco montante e travessa

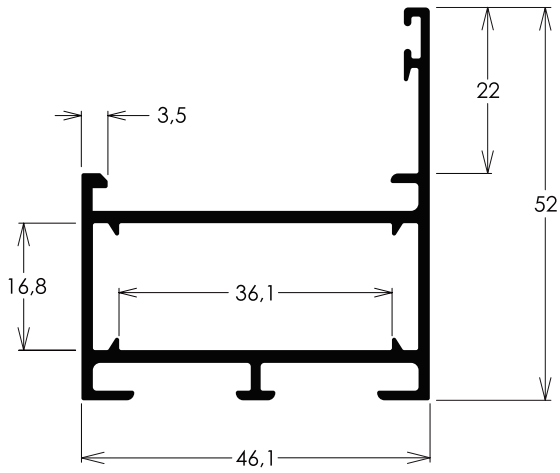

RO078 0,943 kg/m

Marco travessa inferior

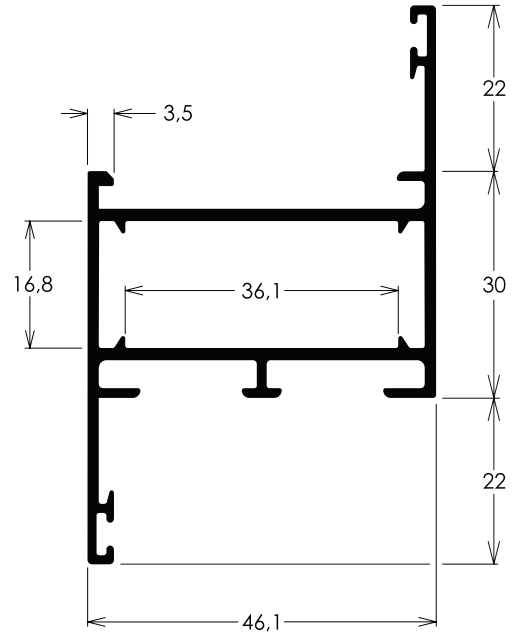

RO079 0,993 kg/m

Marco travessa intermediária

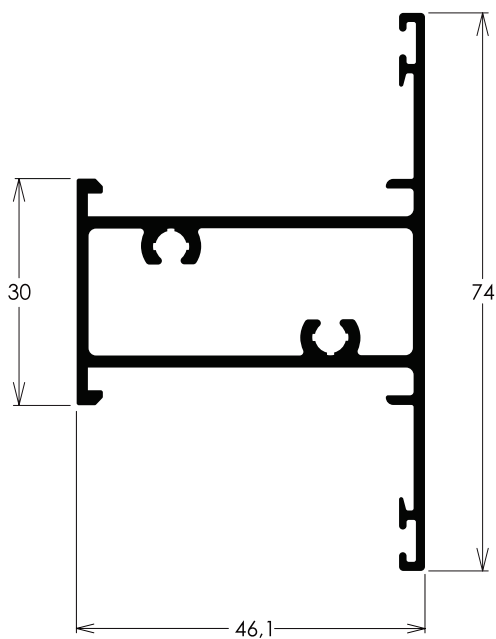

RO080 1,015 kg/m

Folha montante e travessa

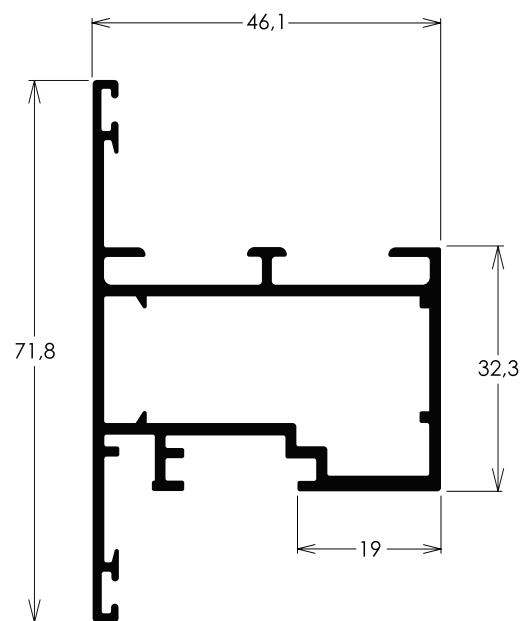

T88

Marco montante e travessa

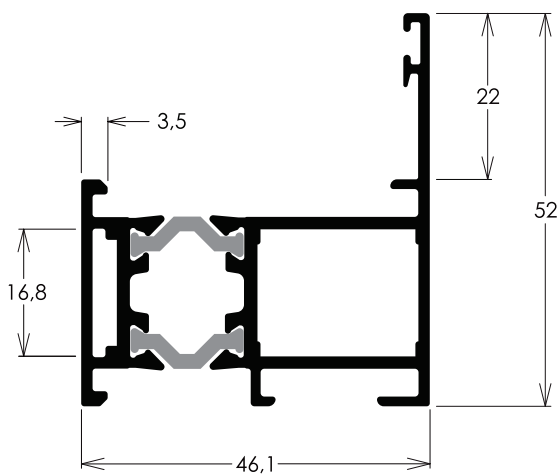

T89

Marco travessa inferior

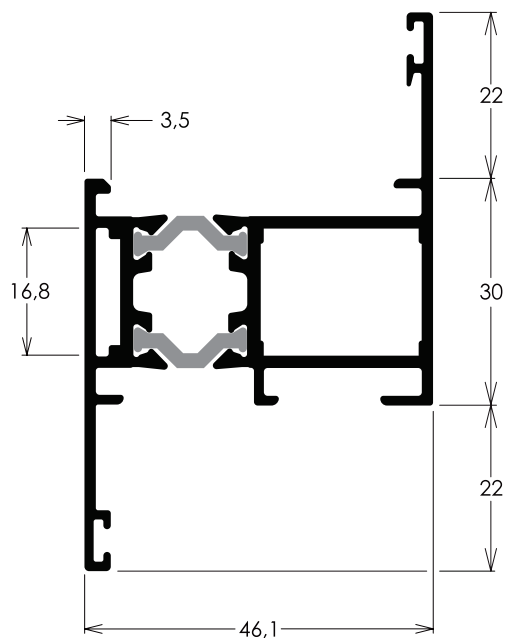

T91

Marco travessa intermediária

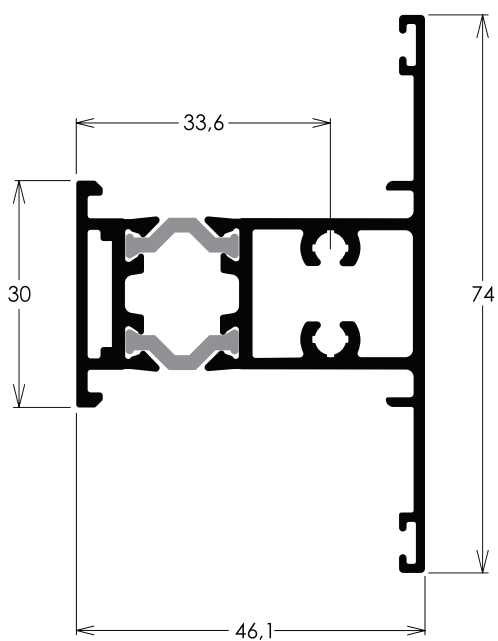

T90

Folha montante e travessa

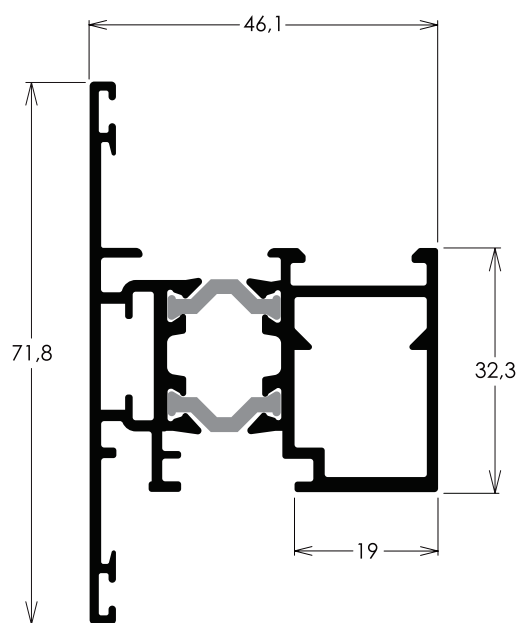

Marco 2 planos e folha

RO048 2,256 kg/m

Marco 2 planos travessa e montante

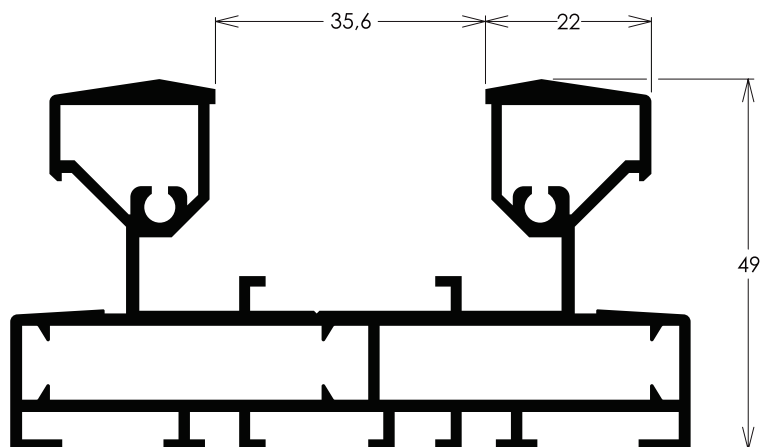

RO049 1,154 kg/m

Folha travessa e montante

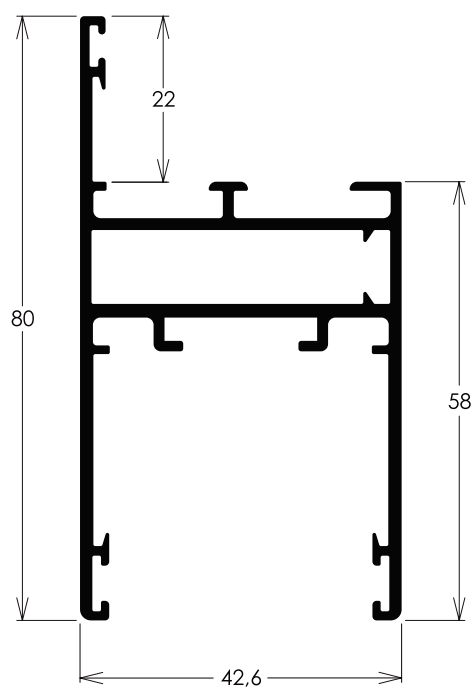

RO064 0,666 kg/m

Complemento mão de amigo

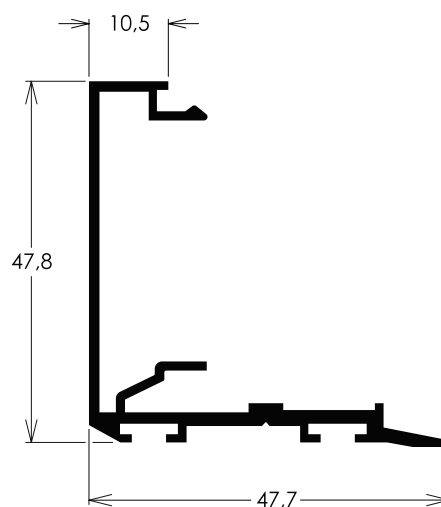

Complementos

RO066 0,642 kg/m

Mata junta folha central

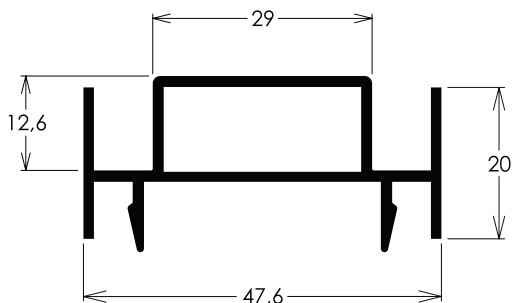

RO050 0,351 kg/m

Complemento vedação de trilho

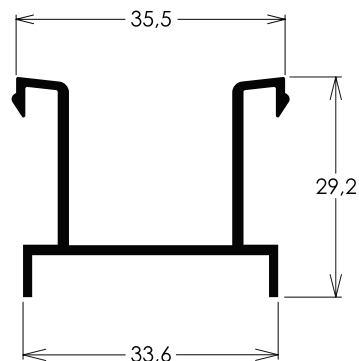

RO068 0,245 kg/m

Vedação inferior do marco

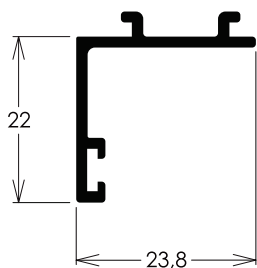

RO051 0,330 kg/m

Pingadeira do marco

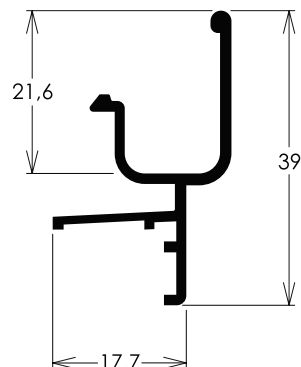

RO090 0,183 kg/m

Complemento

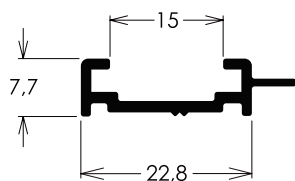

RO065 0,490 kg/m

Complemento reforço

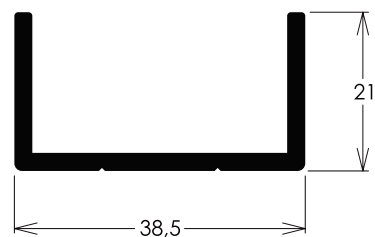

Marco 3 planos

RO057 2,688 kg/m

Marco 3 planos travessa superior

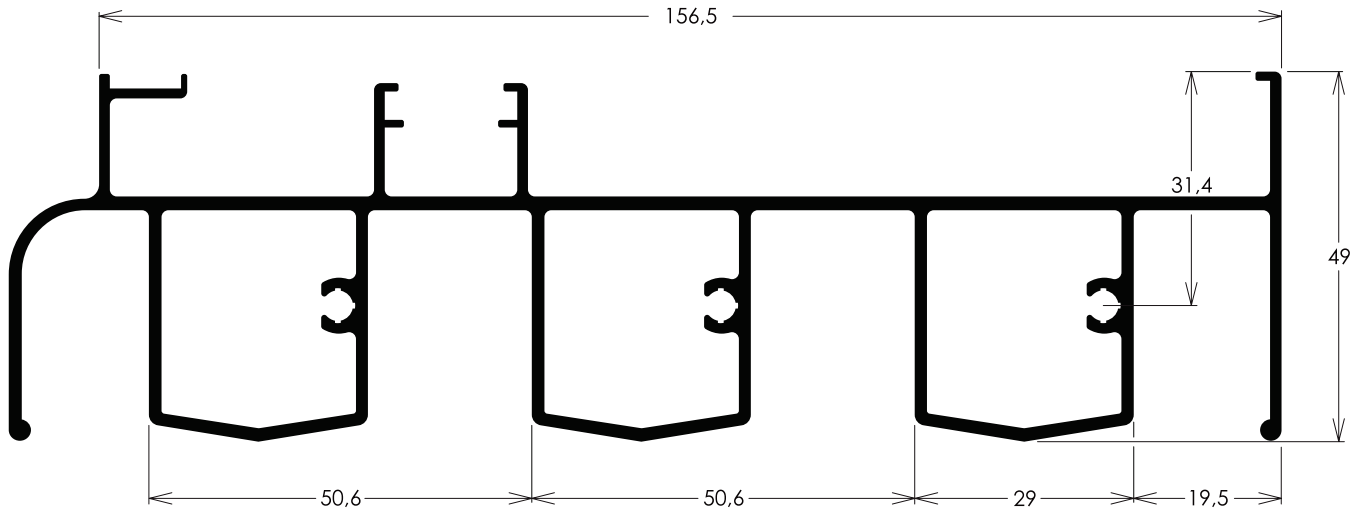

RO056 1,950 kg/m

Marco 3 planos travessa inferior

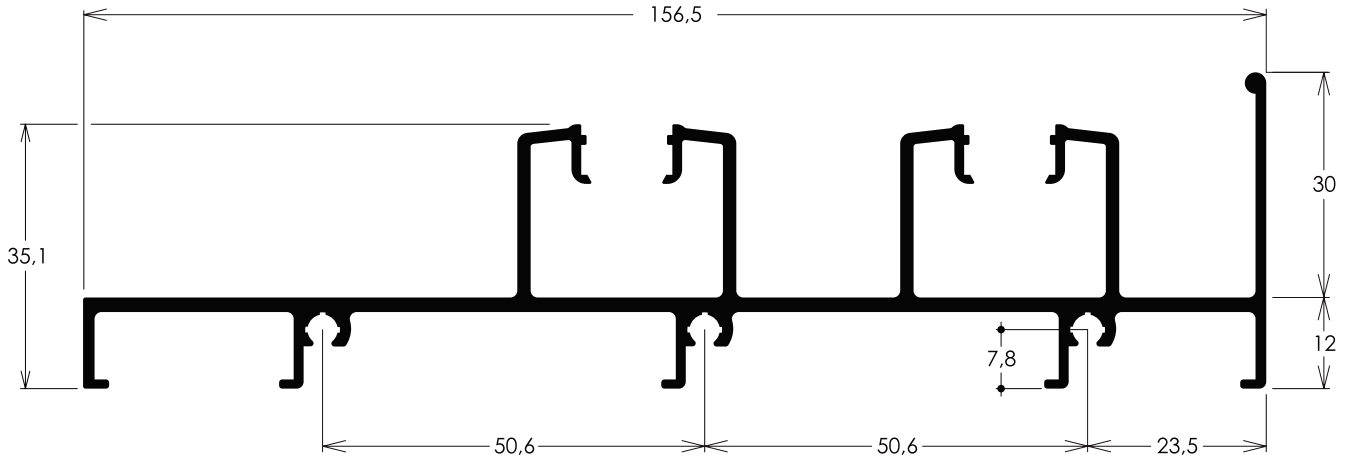

RO058 1,088 kg/m

Marco montante lateral 3 planos

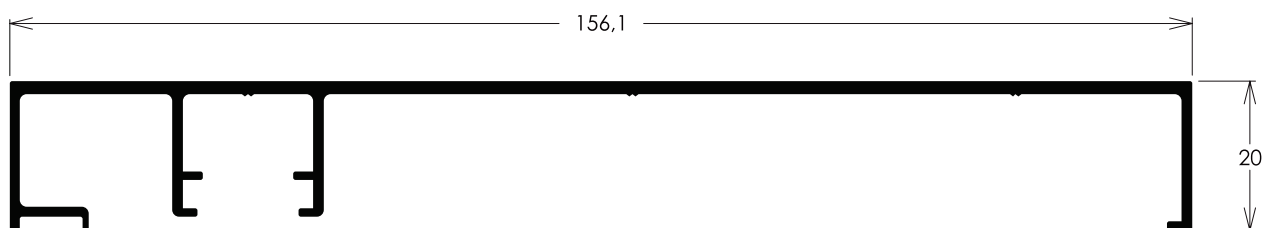

Travessa e trilhos

RO062 1,049 kg/m

Folha travessa intermediária

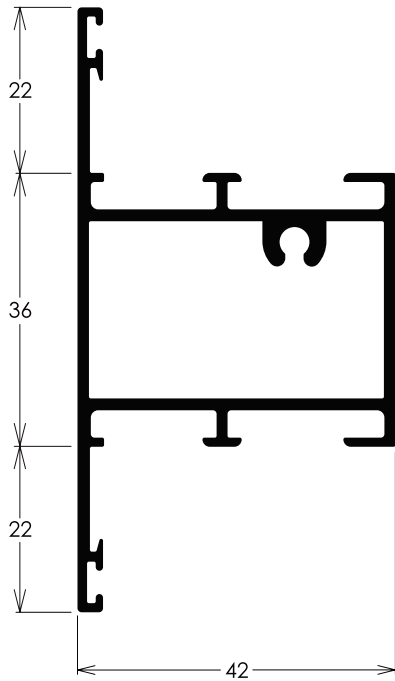

RO055 0,285 kg/m

Pingadeira do marco

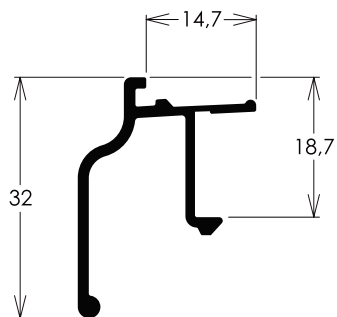

NOTA: Aplicação somente nos perfis RO054 e RO05

RO053 0,198 kg/m

Complemento do trilho

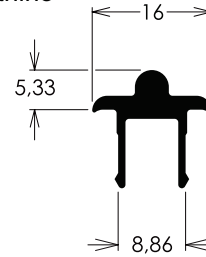

NOTA:

Quando usado no trilho inferior, anodizar fosco A23.

RO052 0,619 kg/m

Trilho único

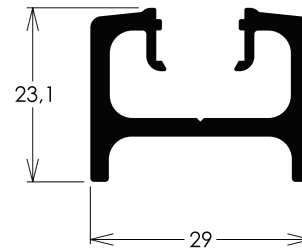

FC234 0,339 kg/m

Tampa de reforço

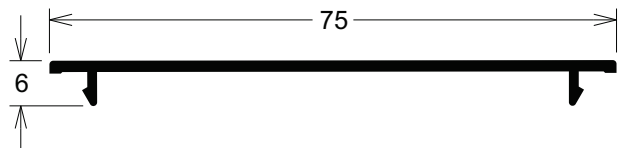

VL040 0,227 kg/m

Tampa de reforço

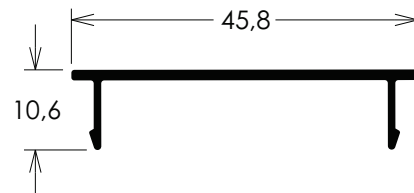

LC021 0,258 kg/m

Tampa do puxador

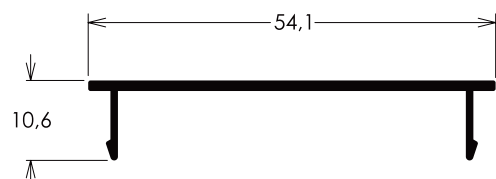

Marco 2 e 3 planos para portas

RO054 2,118 kg/m

Marco 2 planos travessa e montante

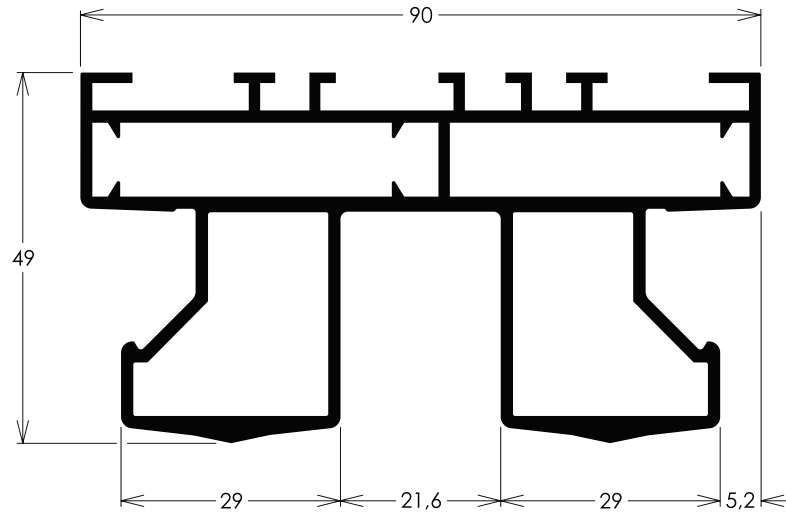
**NOTA:**

Aplicação somente em portas de correr, marcos superior e lateral.

RO059 3,683 kg/m

Marco 3 planos travessa e montante

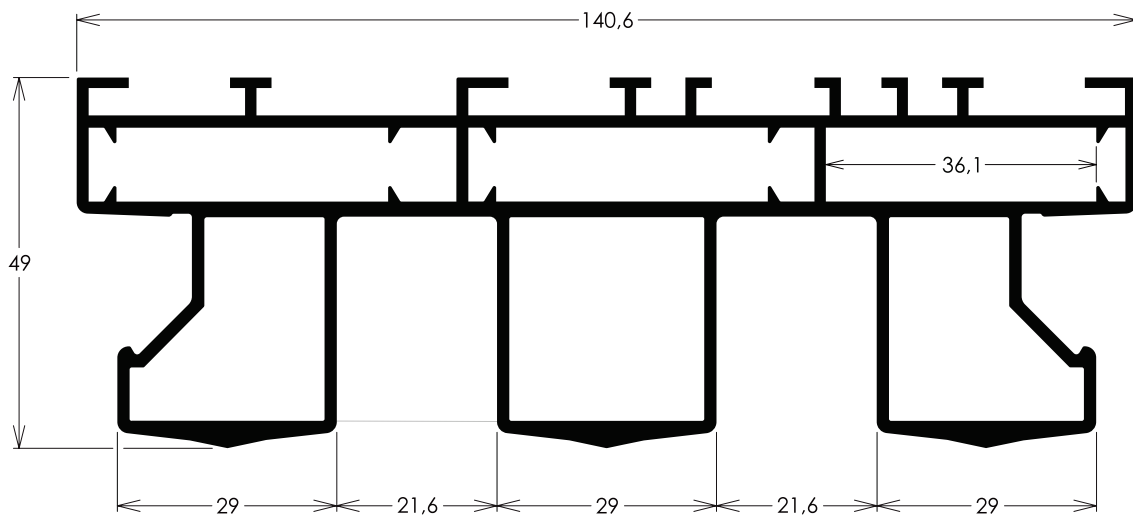
**NOTA:**

Aplicação somente em portas de correr, marcos superior.

RO103 1,977 kg/m

Puxador bola

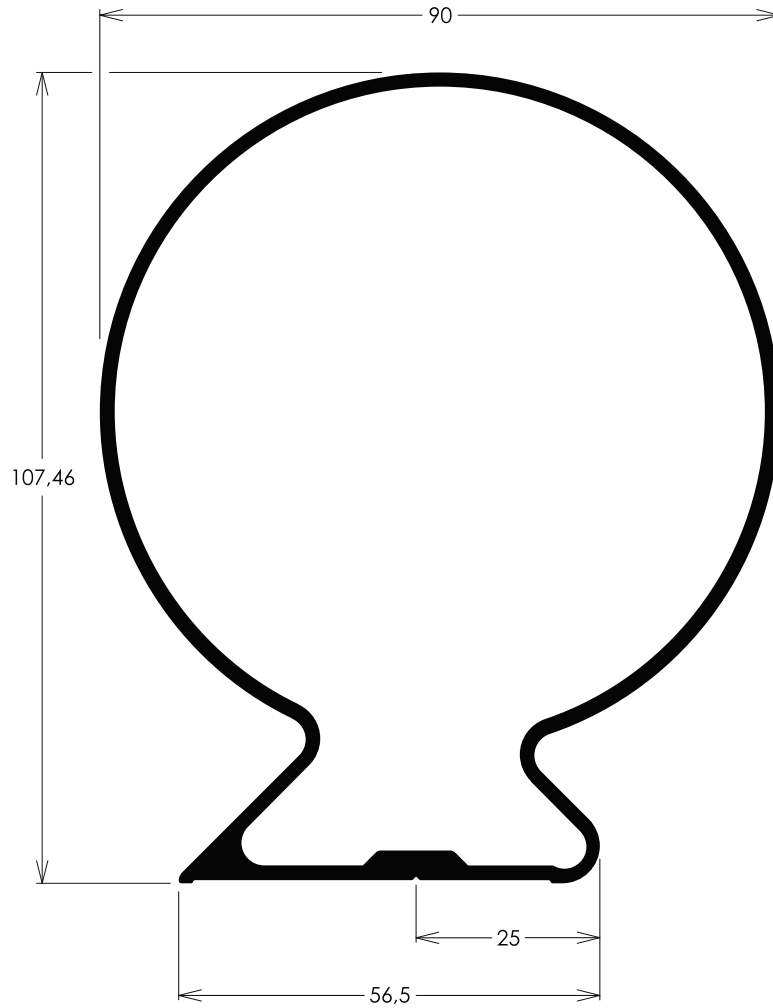

RO100 2,255 kg/m

Puxador

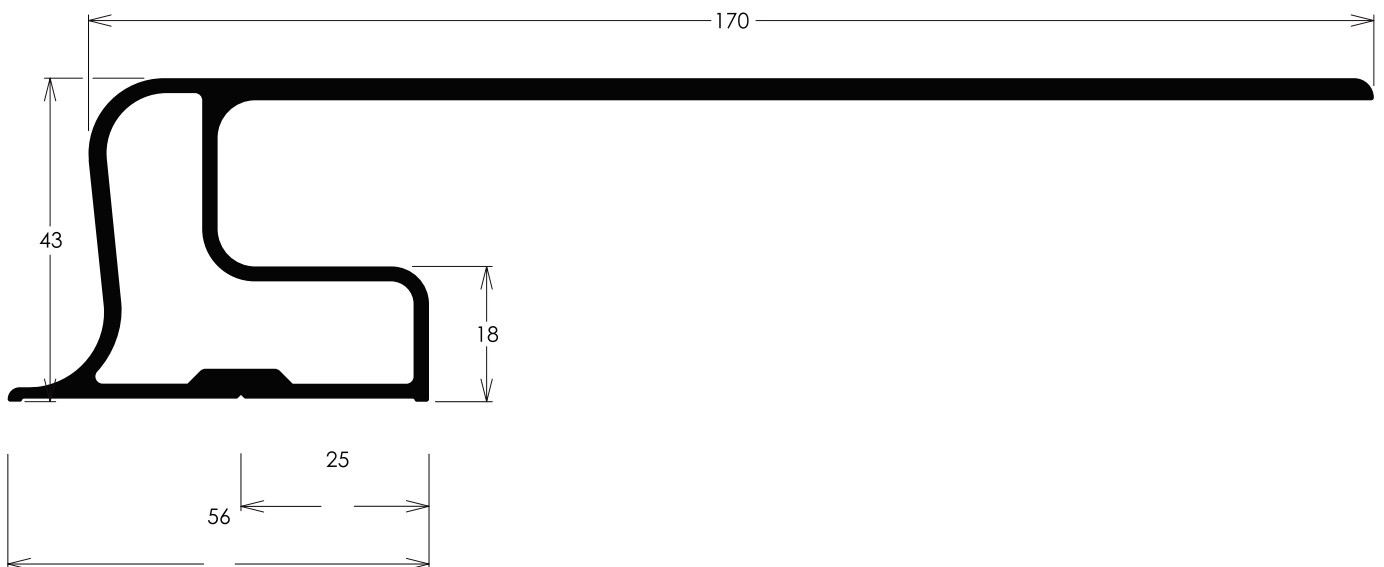

Puxadores

RO102 1,460 kg/m

Puxador bola

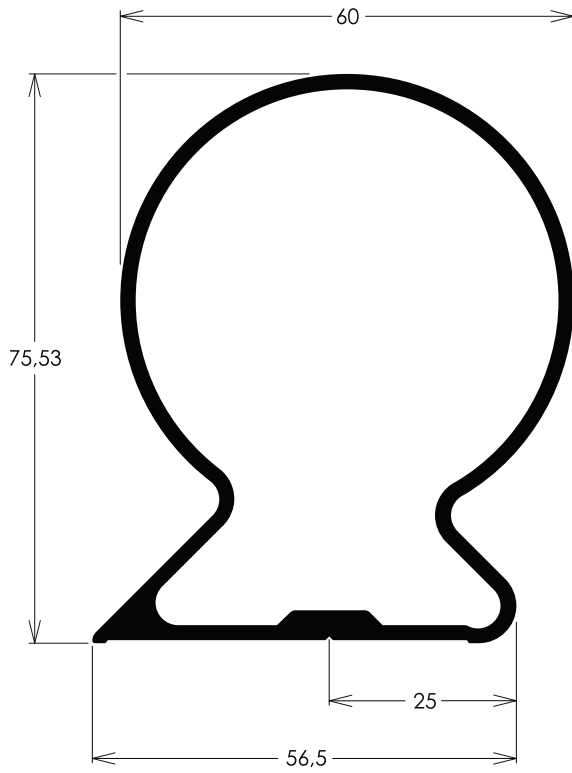

RO101 1,492 kg/m

Puxador S

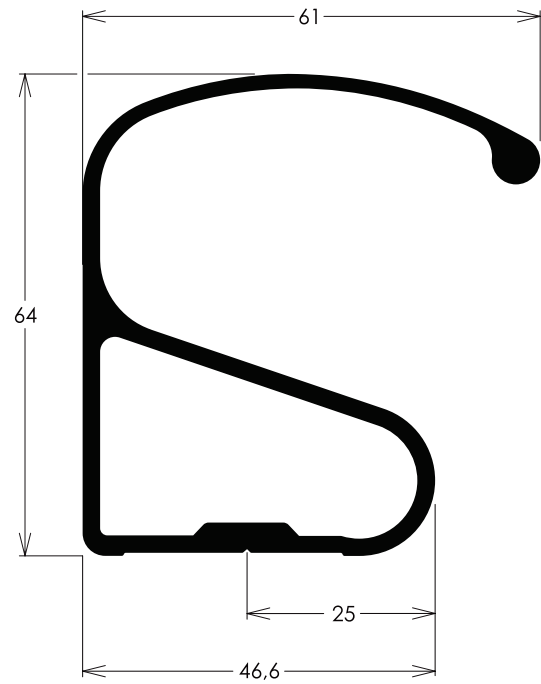

RO164 1,572 kg/m

Puxador

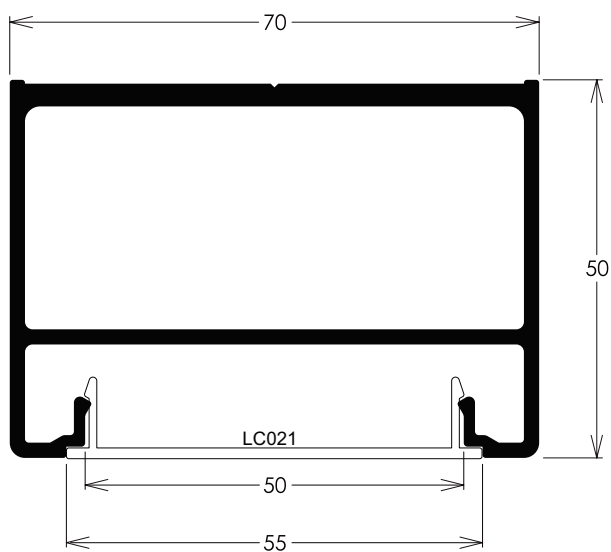

VL101 1,716 kg/m

Puxador

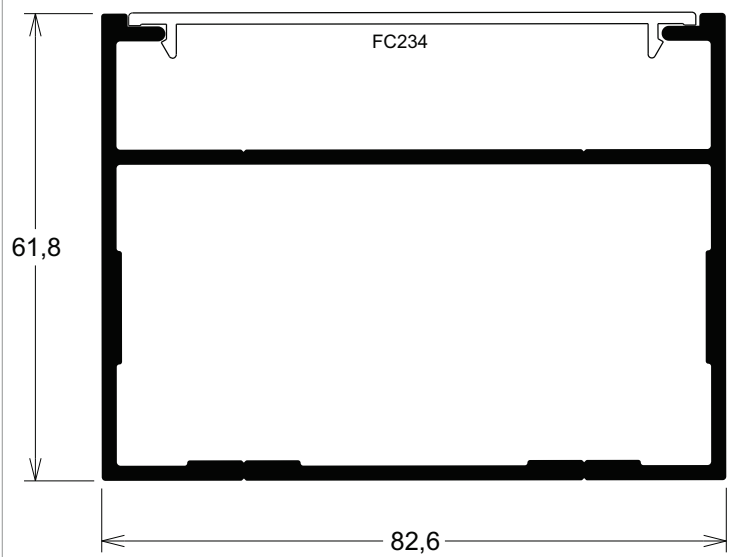

CX8307 2,922 kg/m
Puxador

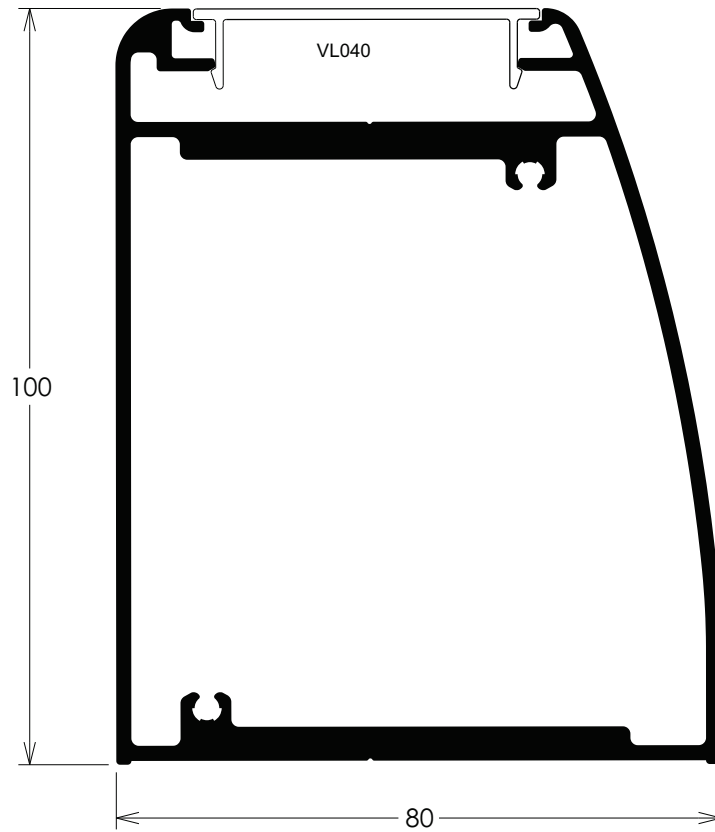

CX8308 3,488 kg/m
Puxador

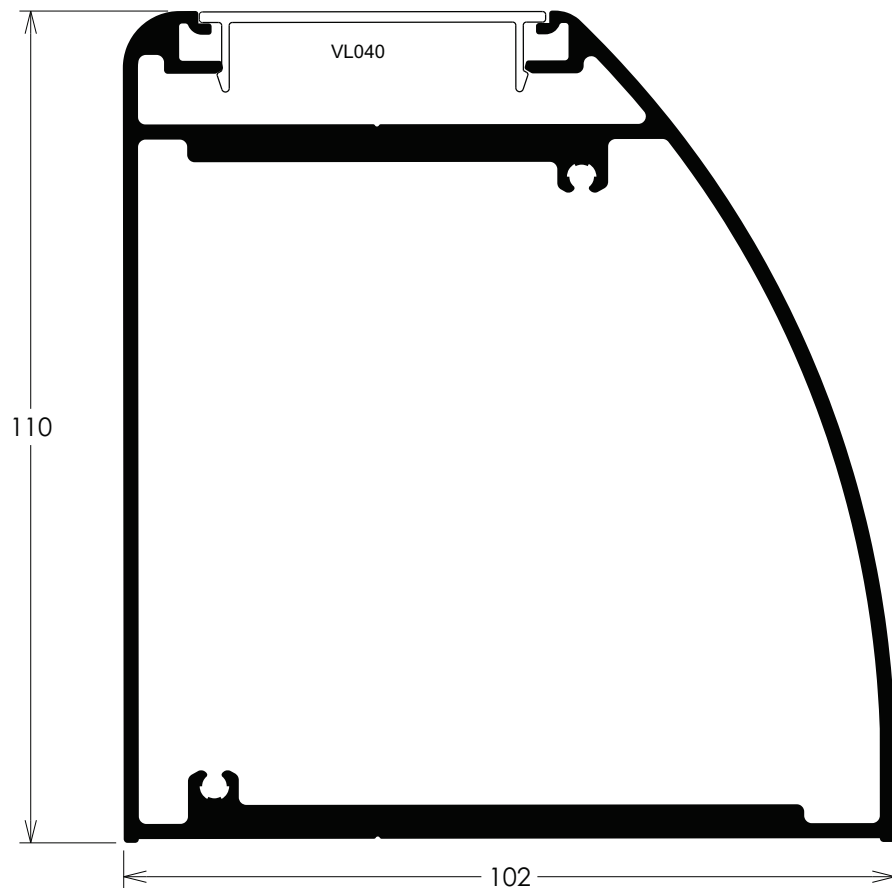

Folha montante e travessa

RO180 1,675 kg/m
Montante com reforço interno

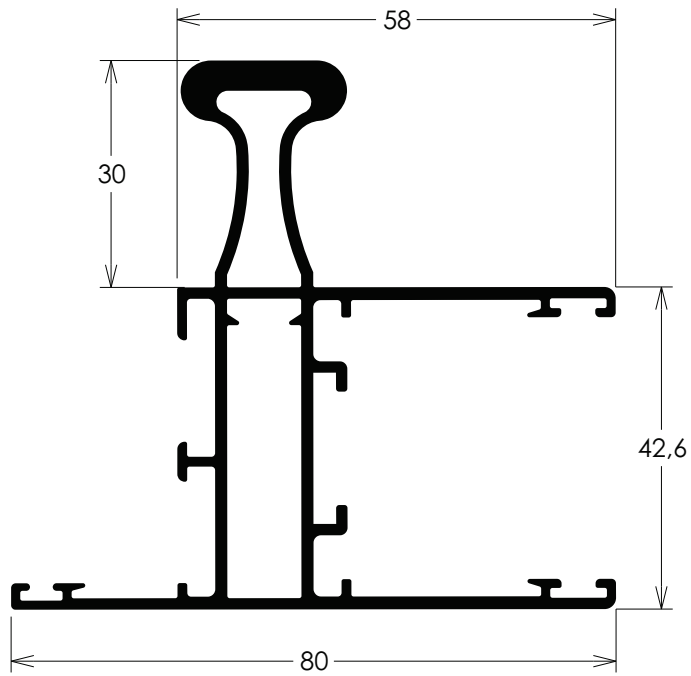

RO225 1,677 kg/m
Montante com reforço externo

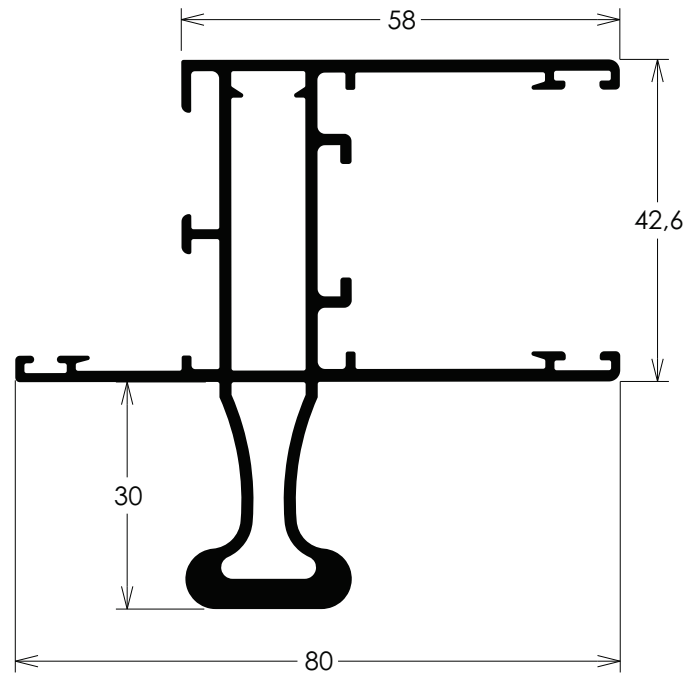

RO147 1,531 kg/m
Folha travessa da porta

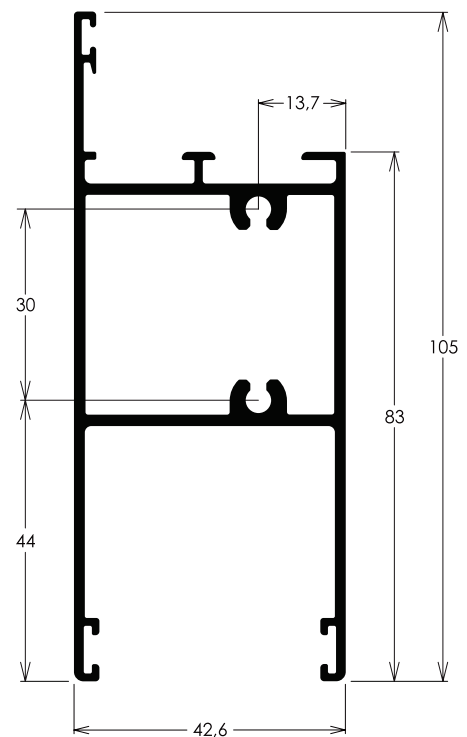

RO063 2,113 kg/m

Folha travessa inferior da porta

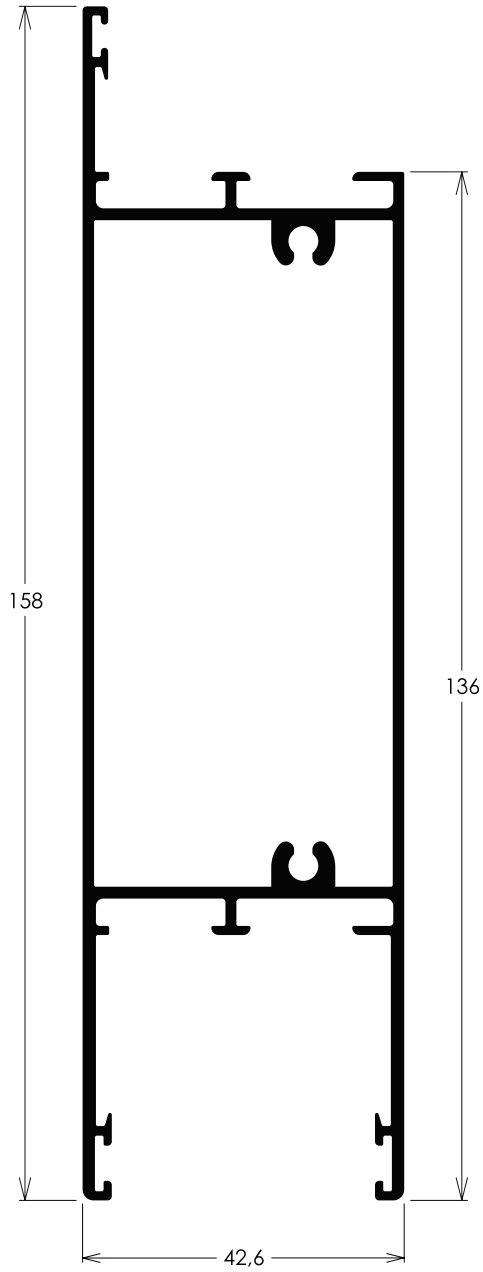

T70

Folha travessa inferior da porta

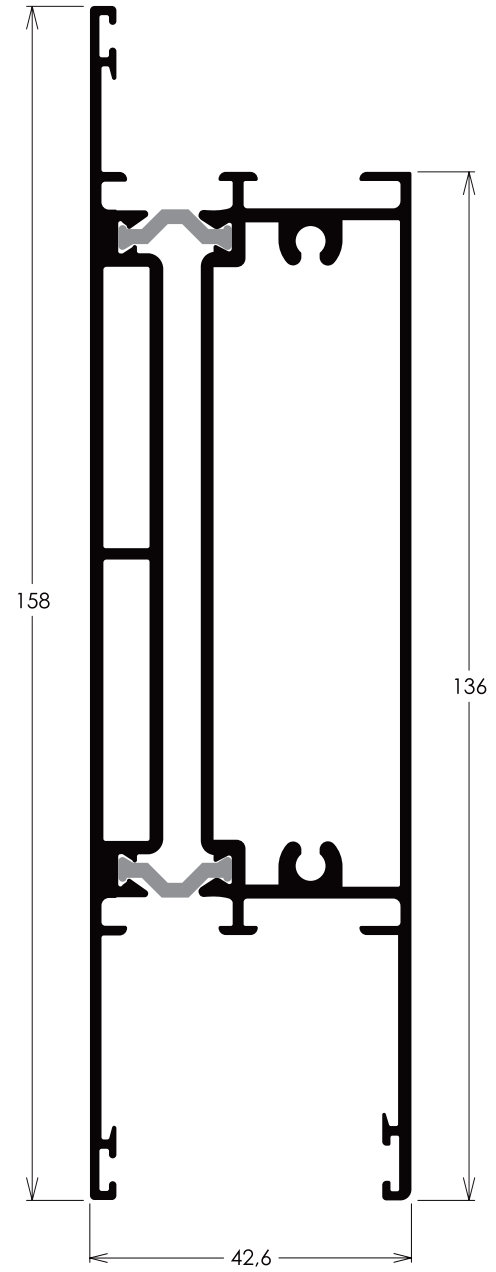

T64

Marco 2 planos travessa e montante

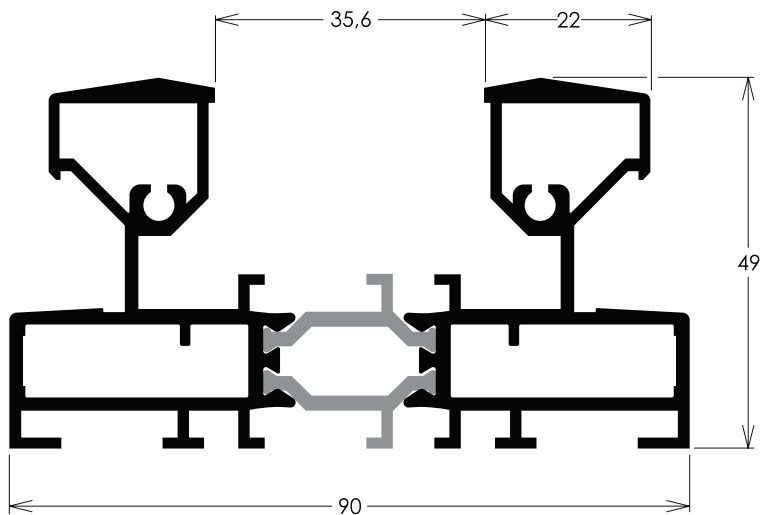
**T65**

Marco 2 planos travessa intermediária

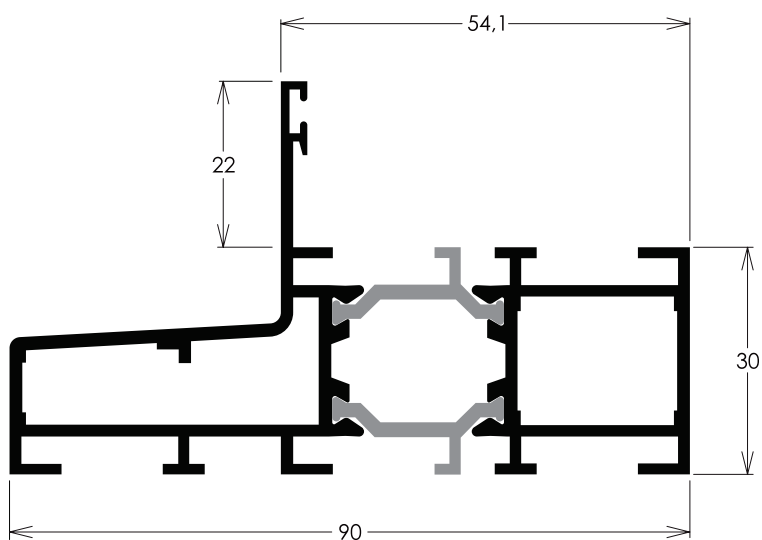

NOTA:
Perfil aplicada somente em janela ou porta com bandeira ou peitoril fixo.

T66

Folha travessa montante da porta

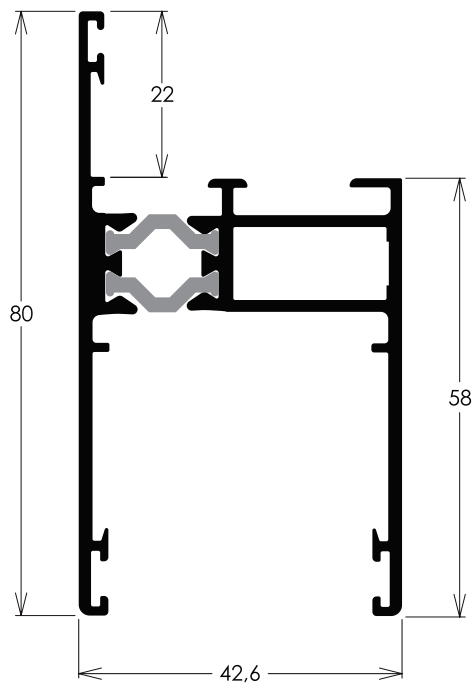

T69

Folha travessa da porta

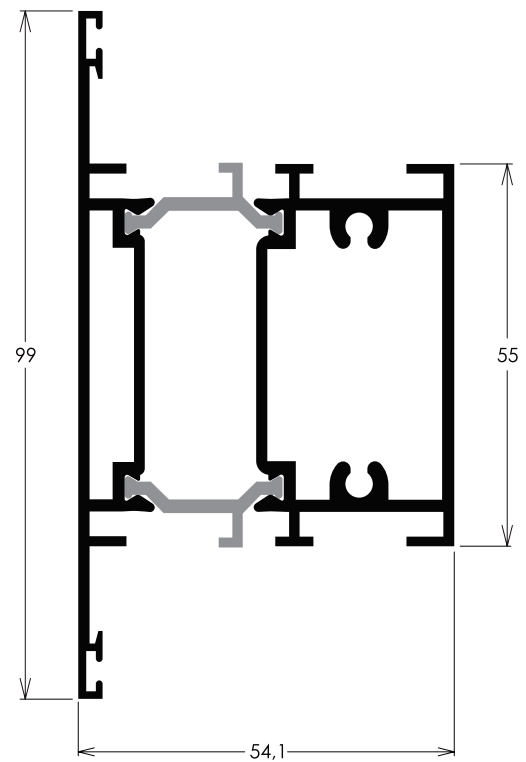

T67

Mata junta folha central

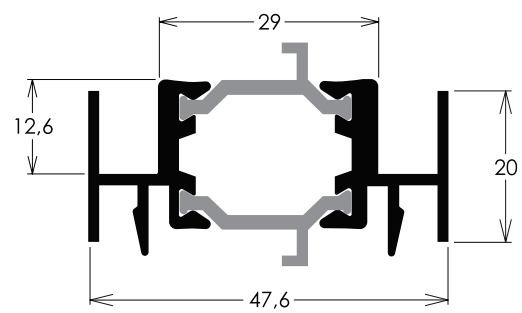

RO031 1,143 kg/m

Folha travessa montante

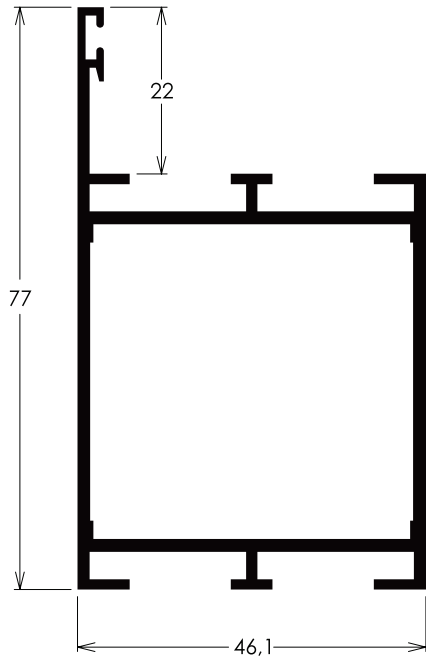

RO039 0,814 kg/m

Complemento

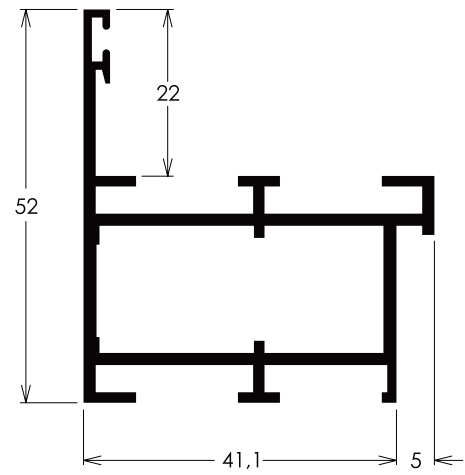

RO046 1,505 kg/m

Marco

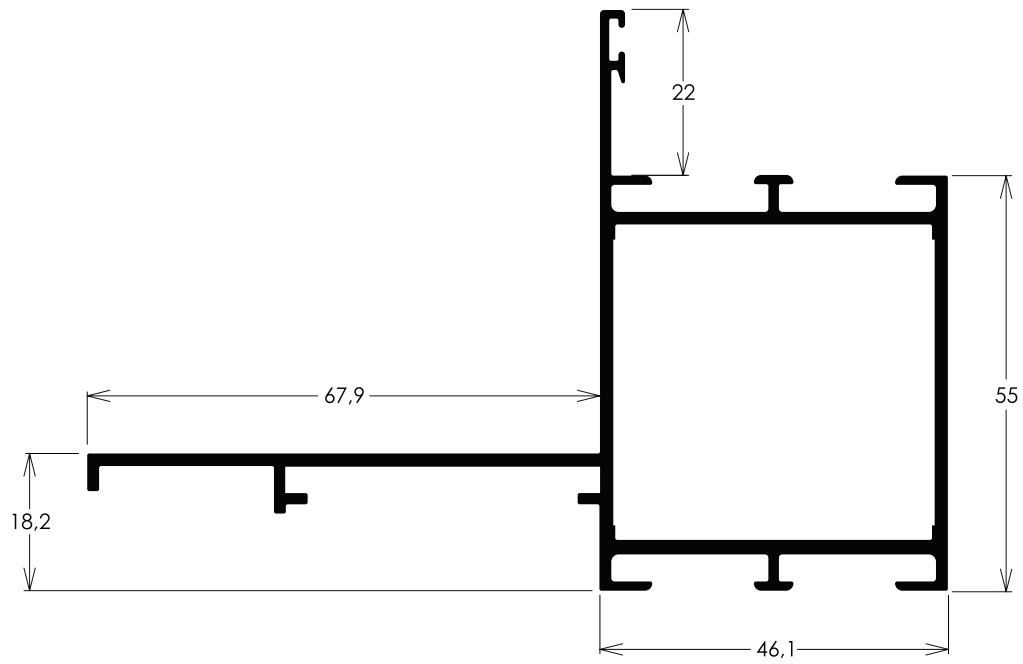
**RO047** 2,391 kg/m

Marco intermediário

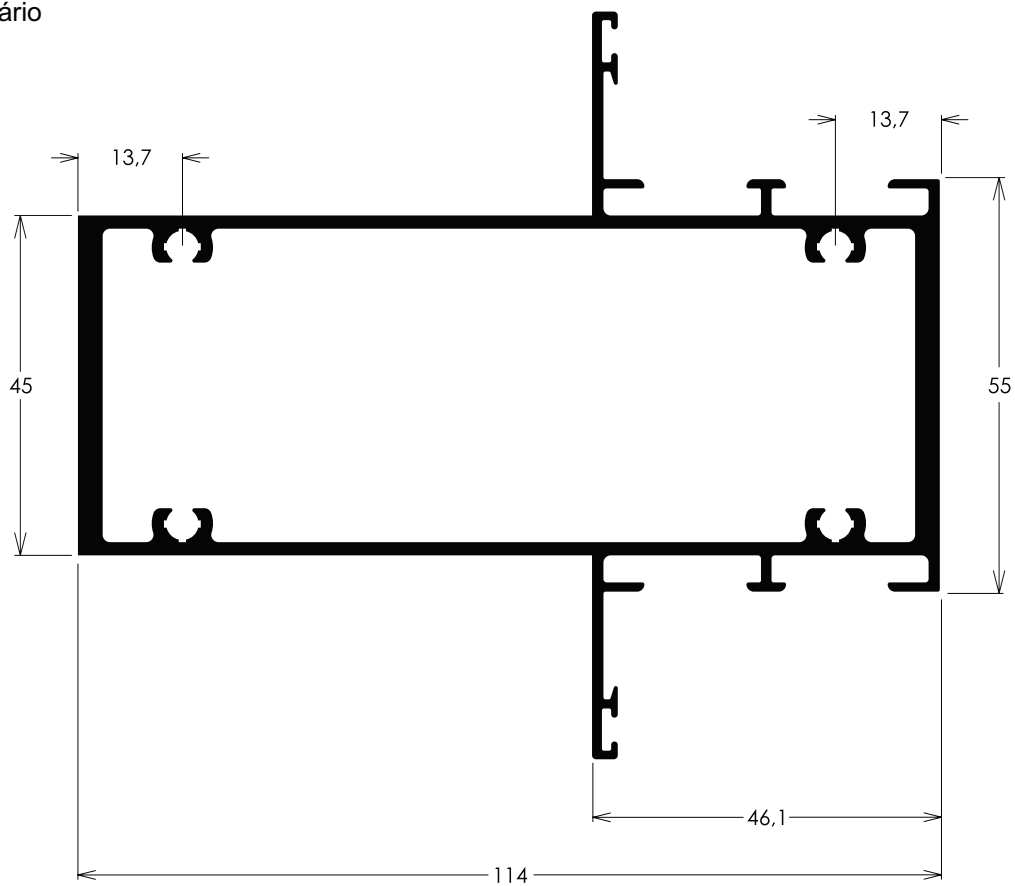

Porta de giro

RO044 2,029 kg/m

Folha travessa intermediária

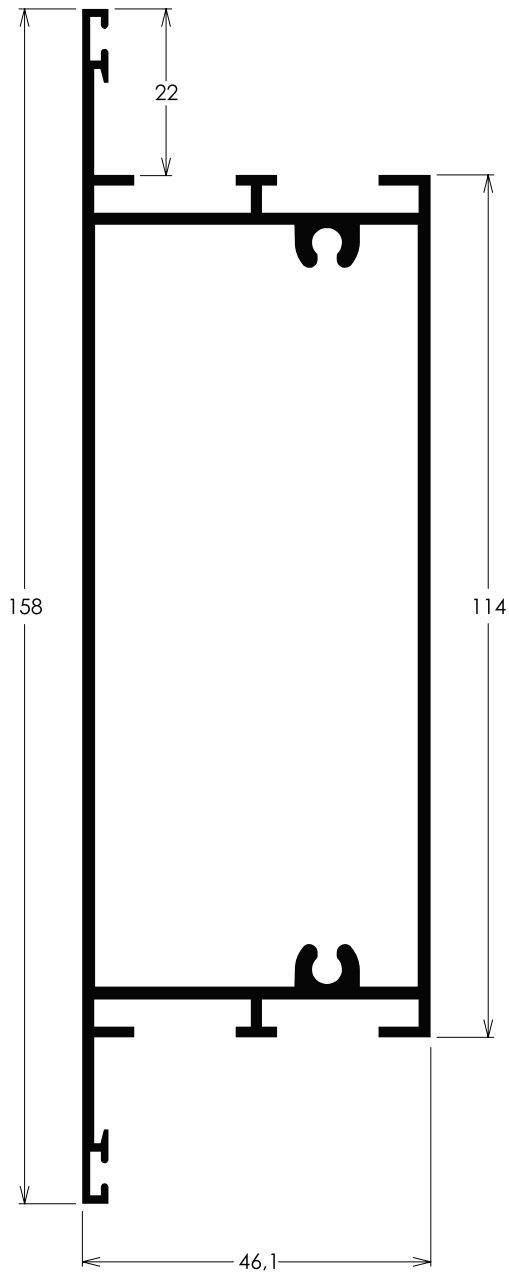

RO045 2,137 kg/m

Folha travessa inferior

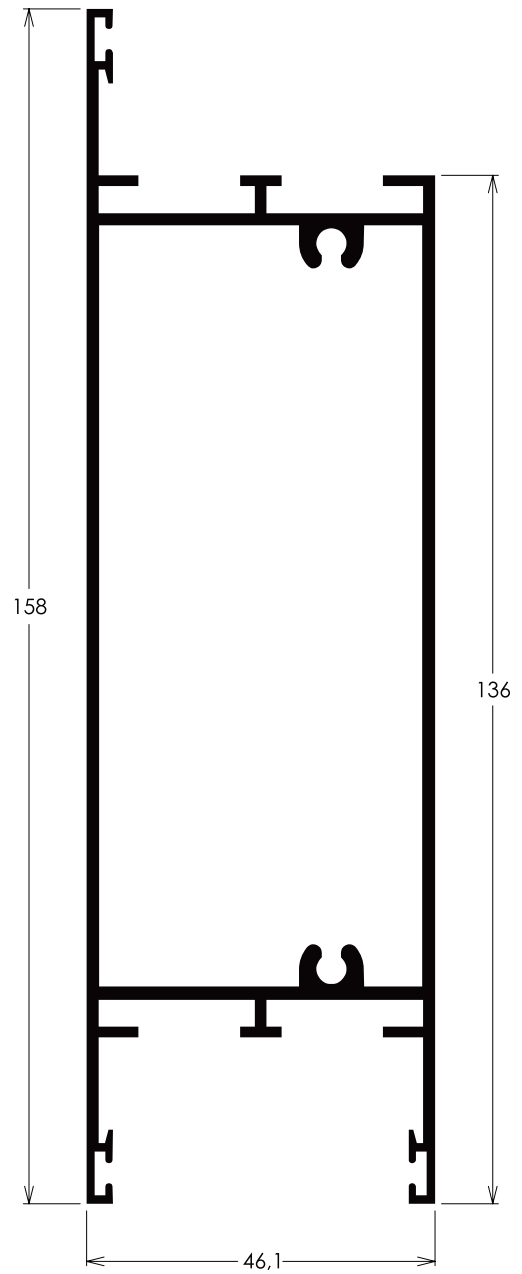

Porta de giro

RO033 1,251 kg/m

Folha travessa intermediária

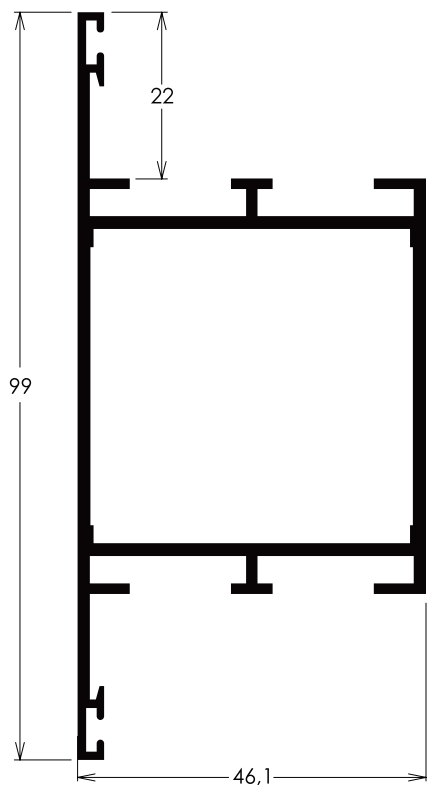

RO034 1,418 kg/m

Folha travessa intermediária

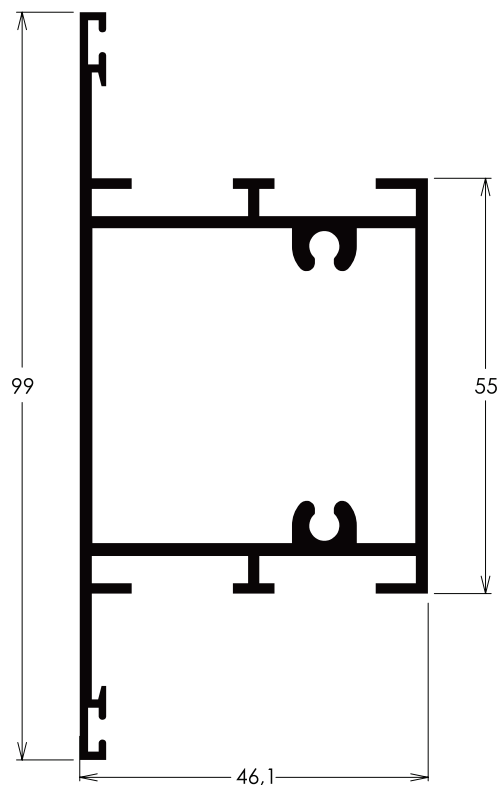

RO035 0,692 kg/m

Complemento

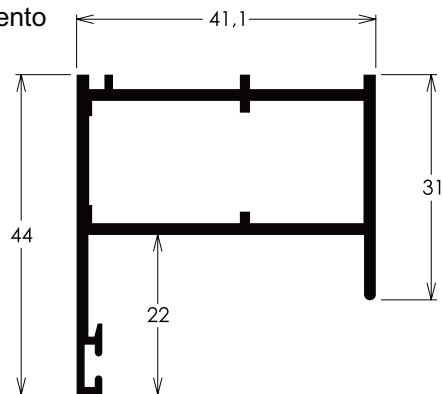

RO040 0,444 kg/m

Vedador inferior

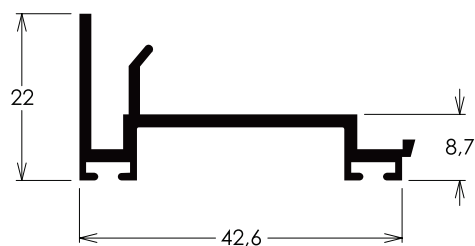

RO036 0,193 kg/m

Calço

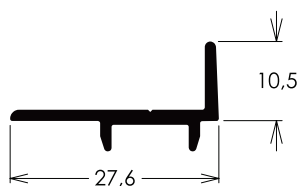

RO089 0,230 kg/m

Vedador inferior

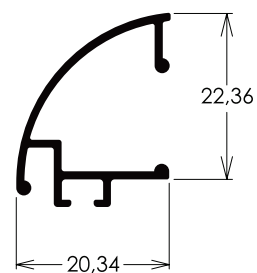

Porta de giro

RO041 1,251 kg/m

Inversor

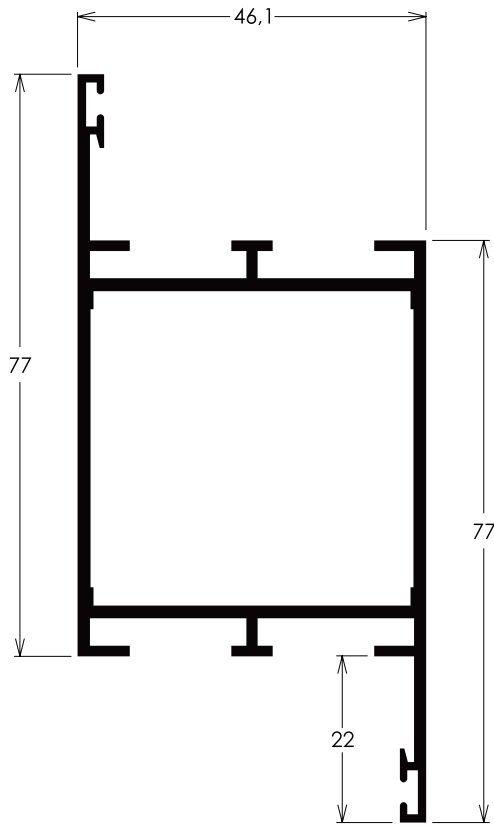

RO032 1,071 kg/m

Marco montante e travessa

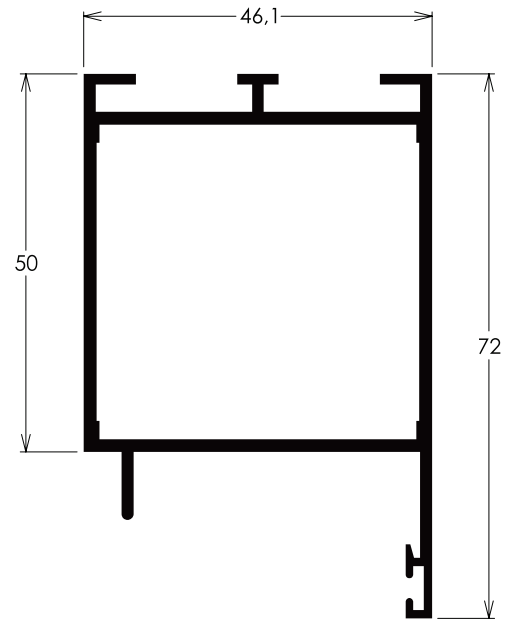

RO042 1,180 kg/m

Folha travessa e montante

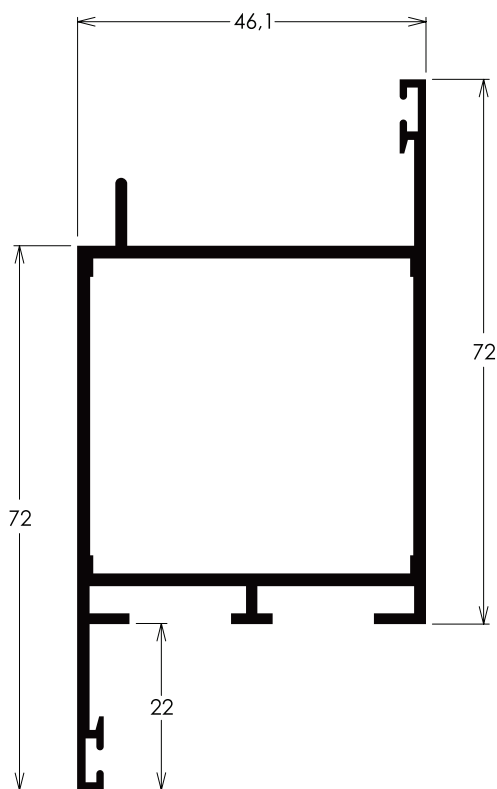

RO043 1,180 kg/m

Folha travessa e montante

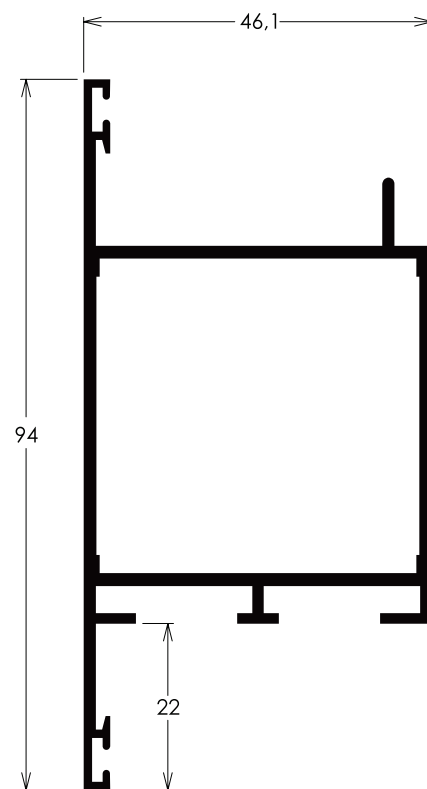

Porta de giro

T71

Marco montante e travessa

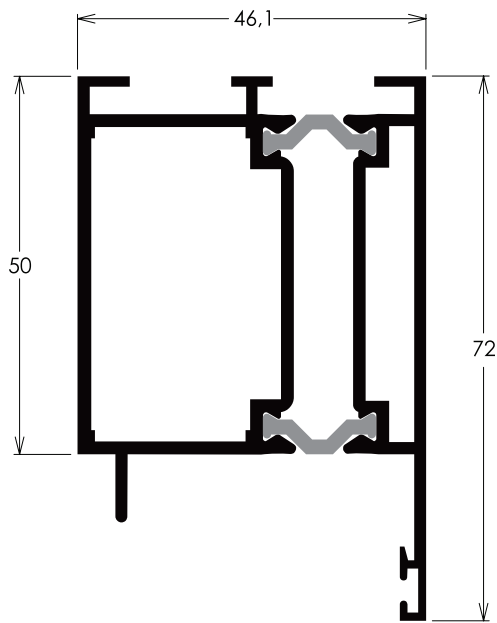

T72

Marco montante e travessa

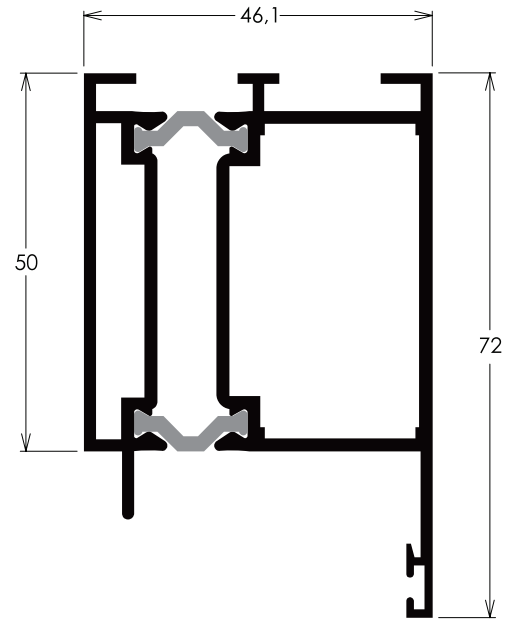

T73

Folha travessa e montante

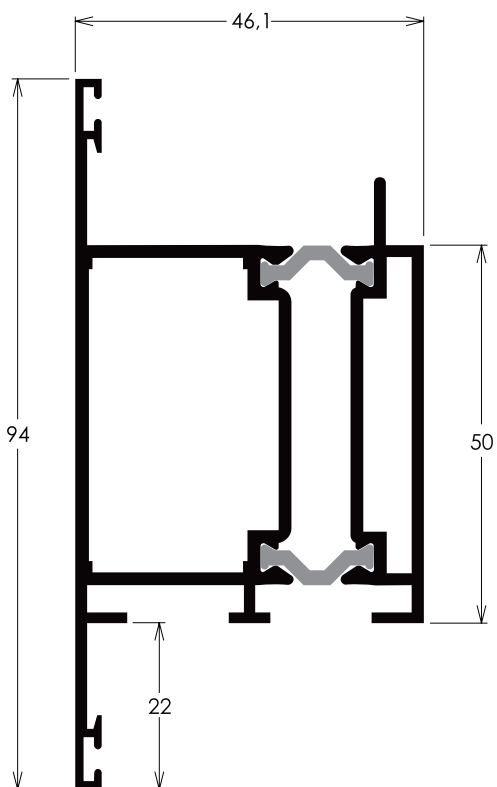

T74

Folha travessa e montante

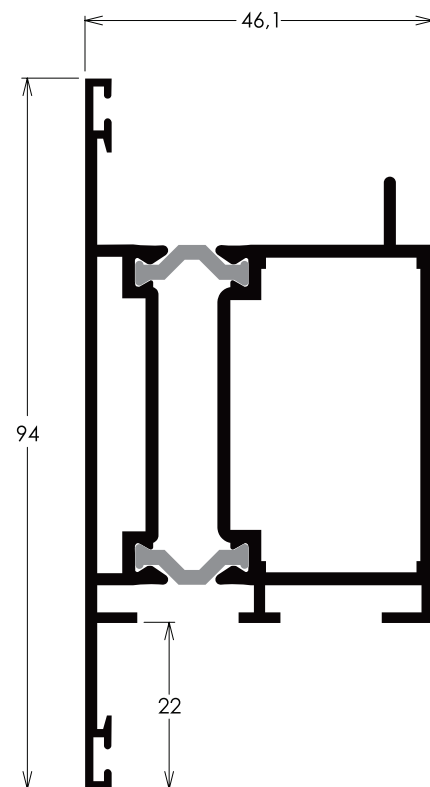

T78
Inversor

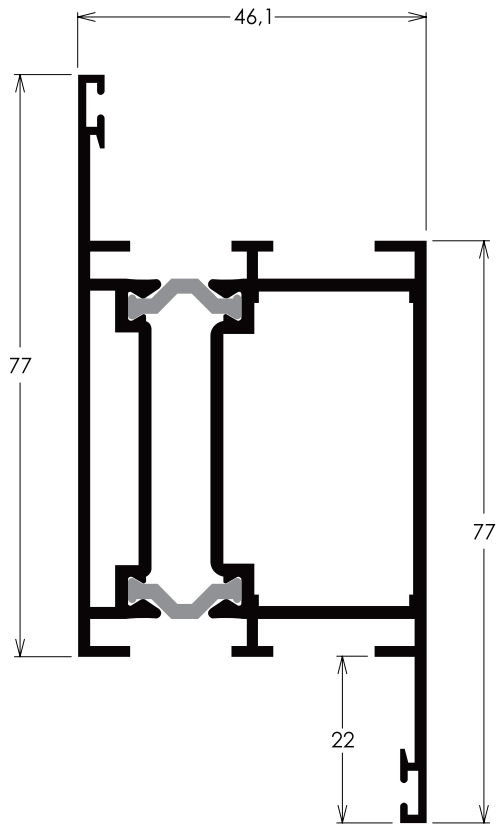

T79
Marco montante e travessa

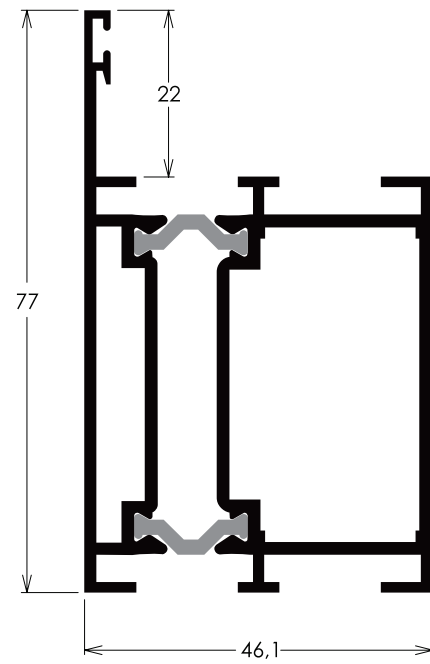

T81
Travessa intermediária

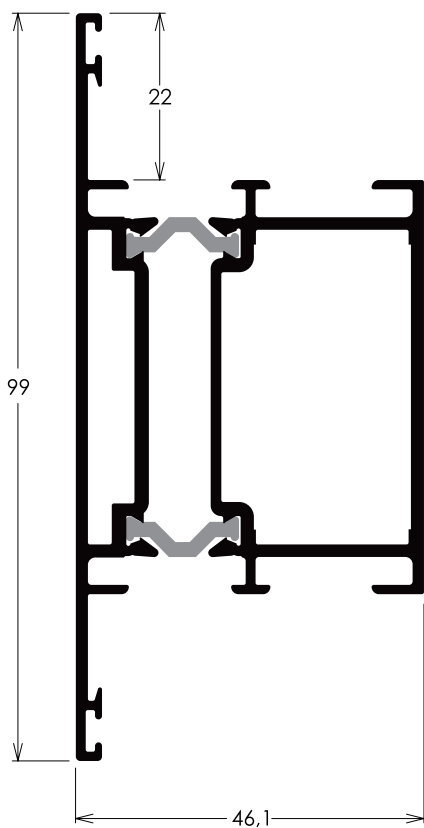

T80
Folha travessa e montante

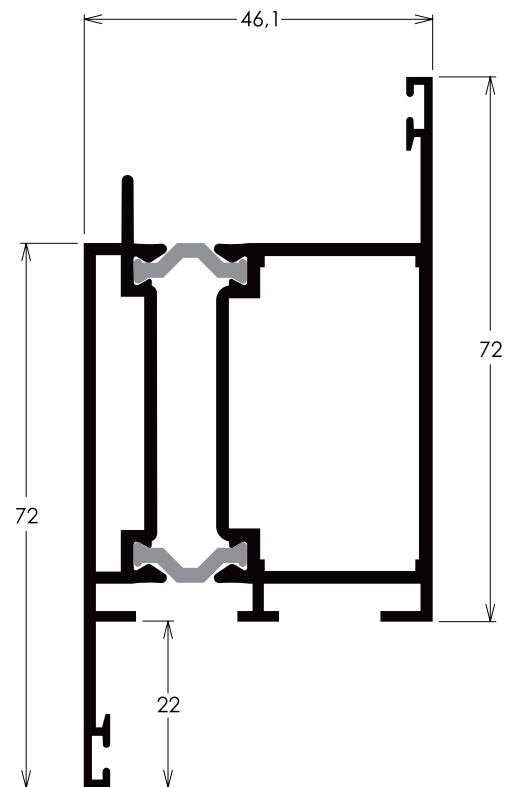

Porta de giro

T75

Complemento

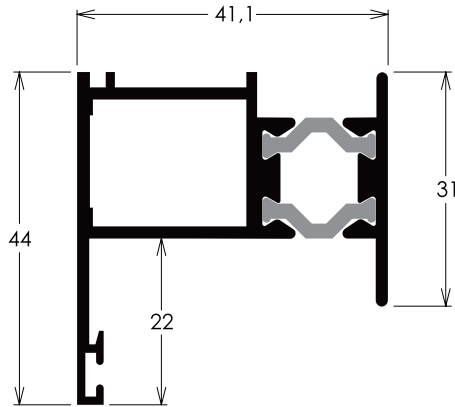

T77

Travessa intermediária

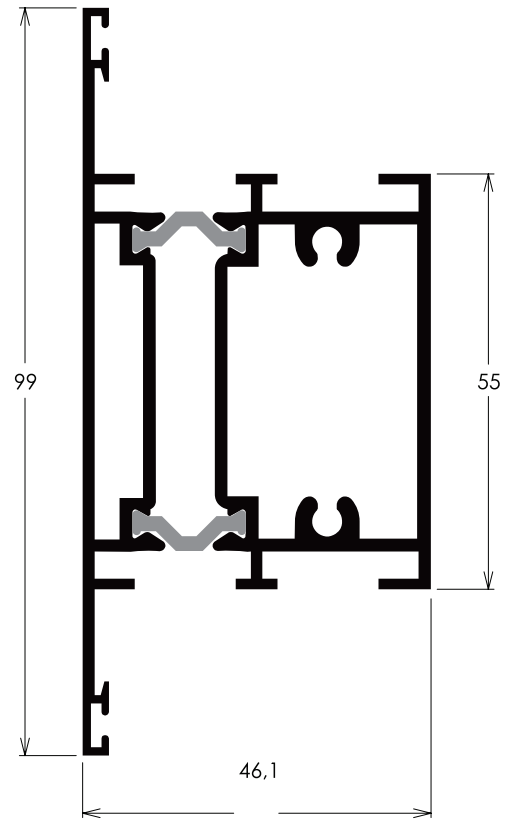

T76

Complemento

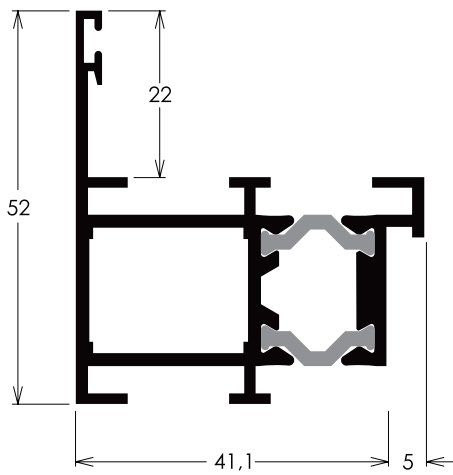

RO172 0,284 kg/m

Vedação

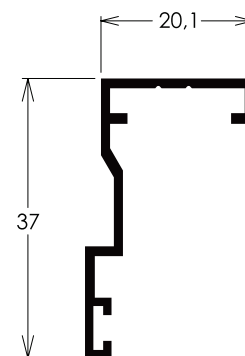

T83

Folha travessa intermediária

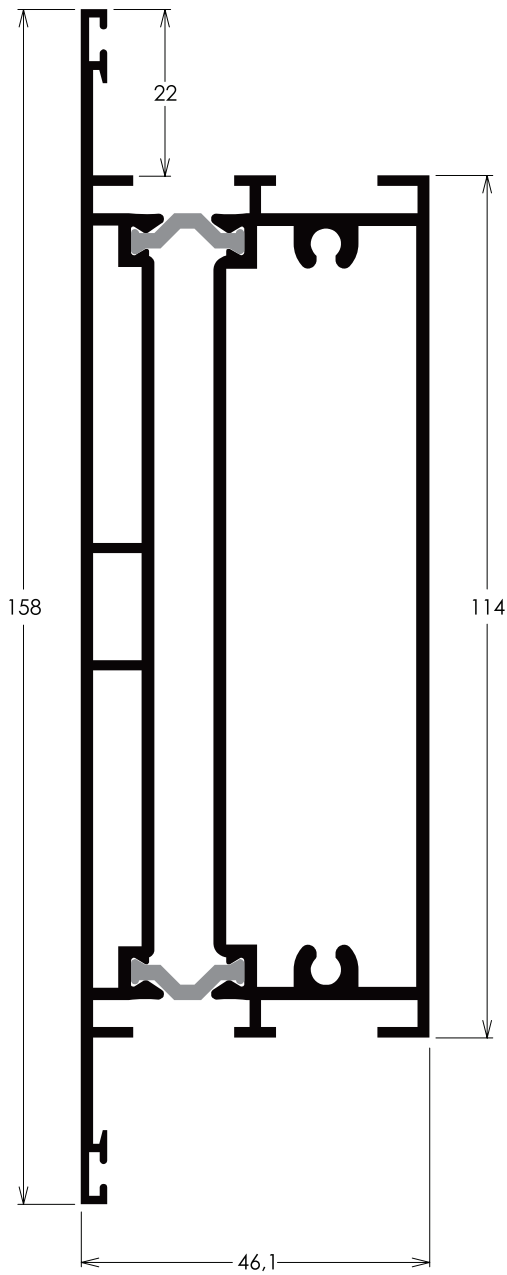

T82

Folha travessa inferior

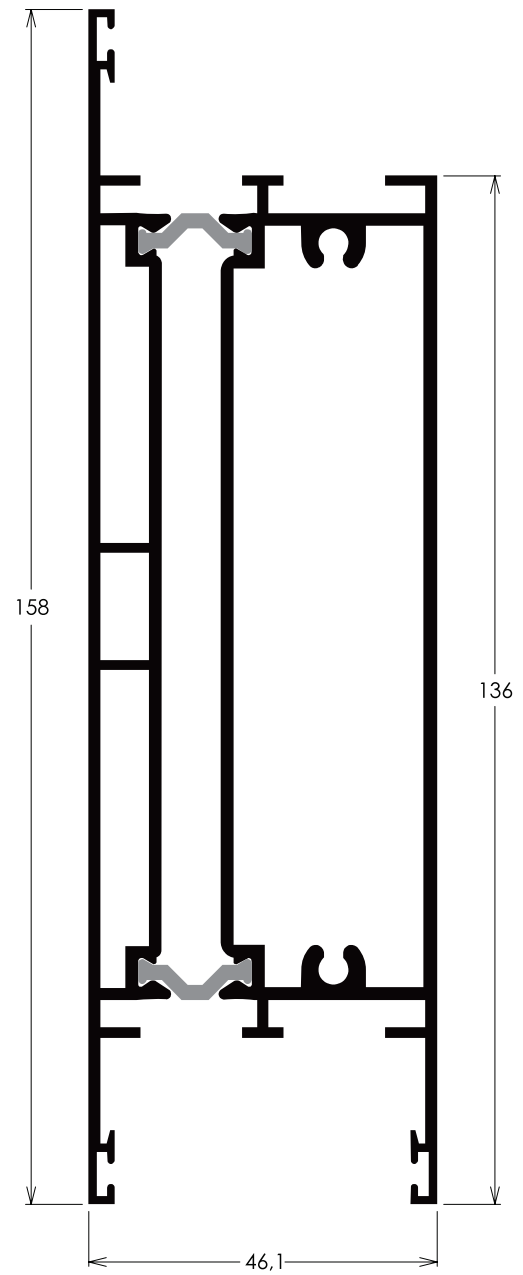

RO171 0,575 kg/m

Complemento de piso

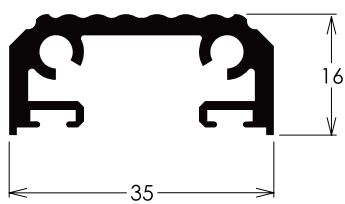

RO173 0,273 kg/m

Pingadeira inferior

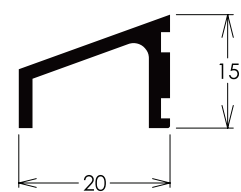

Marco e folha elevável

RO075 1,900 kg/m

Marco 2 planos travessa e montante

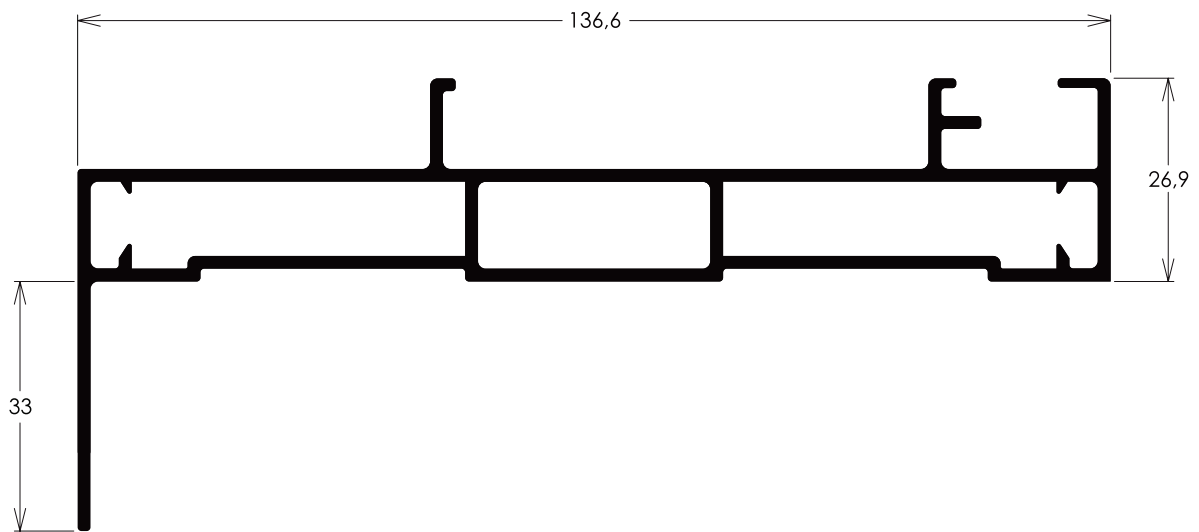

RO092 2,015 kg/m

Folha travessa e montante

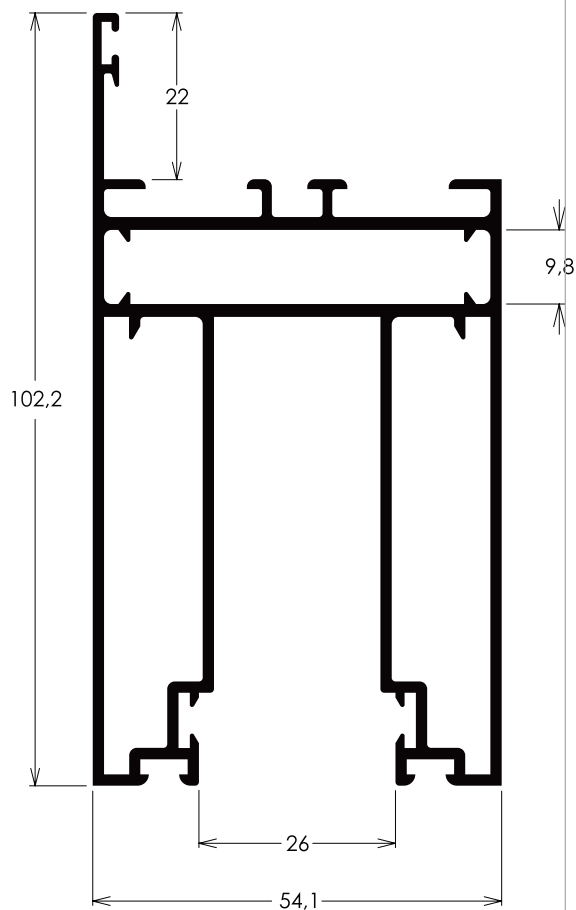

RO224 0,188 kg/m

Complemento

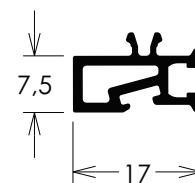

Marco e complemento elevável

RO076 1,159 kg/m

Marco 1 plano travessa e montante

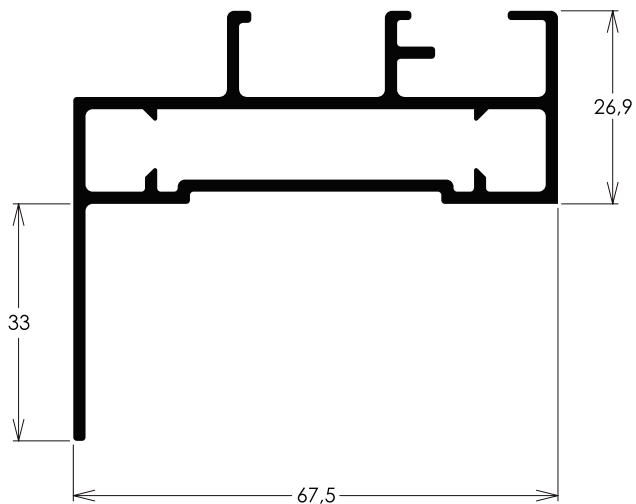

RO085 0,973 kg/m

Mata junta

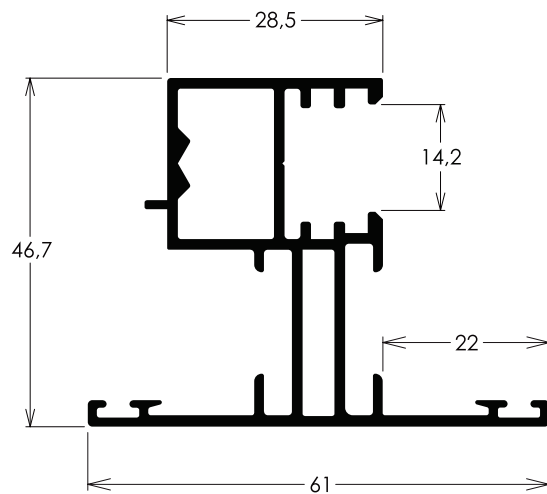

RO093 0,717 kg/m

Trilho

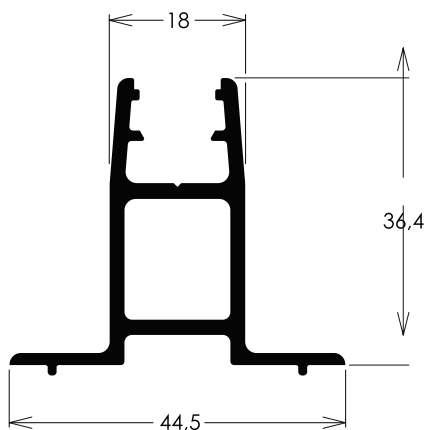

RO094 0,693 kg/m

Complemento mão de amigo

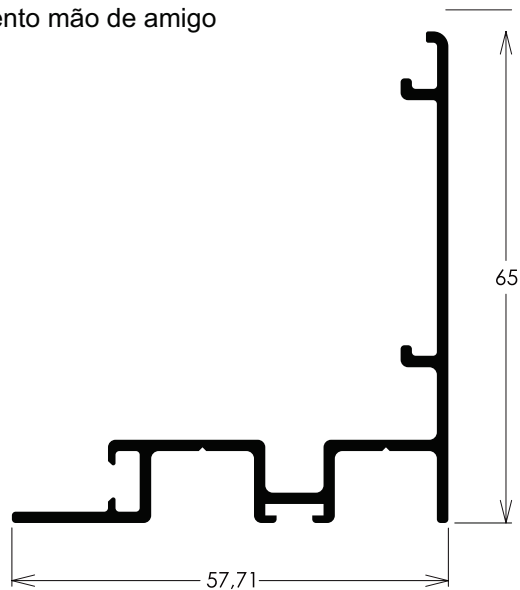

RO150 0,555 kg/m

Trilho

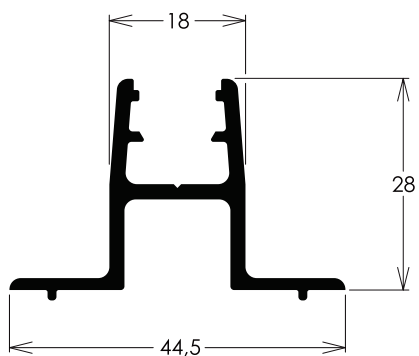

RO095 0,304 kg/m

Trilho

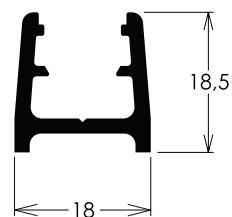

Integrada

CM168 0,957 kg/m

Requadro em alumínio natural

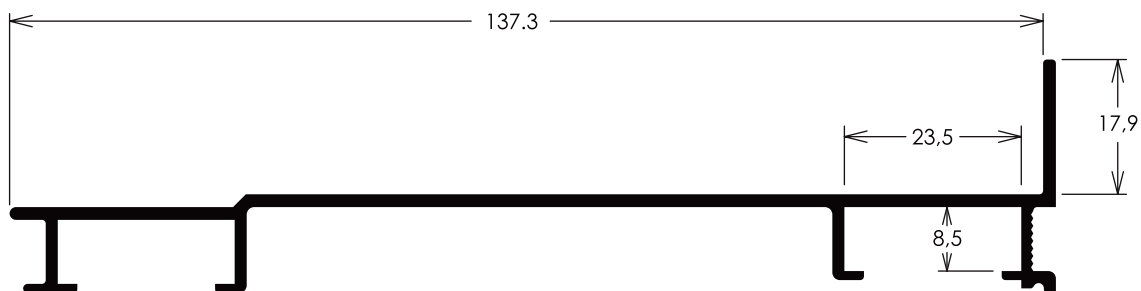

LG168 1,094 kg/m

Marco travessa superior integrada

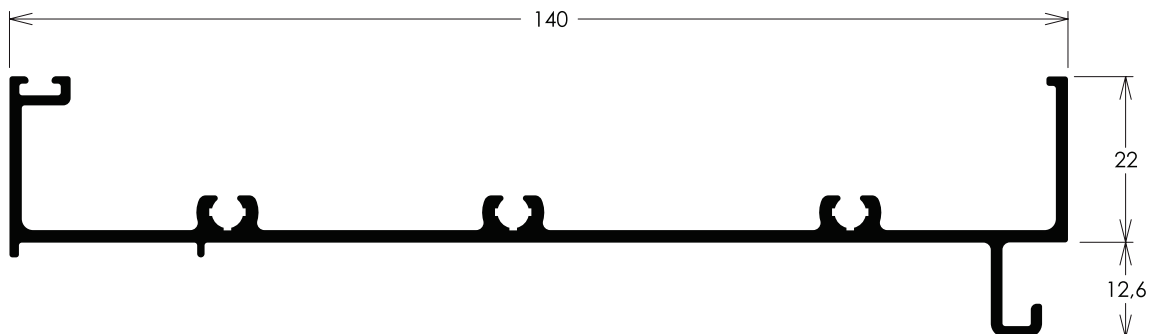

LG170 0,827 kg/m

Marco lateral integrada

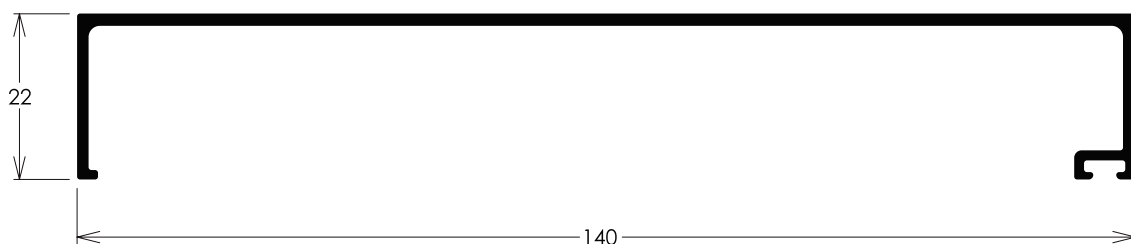

Integrada

RO168 1,480 kg/m

Marco travessa intermediária integrada

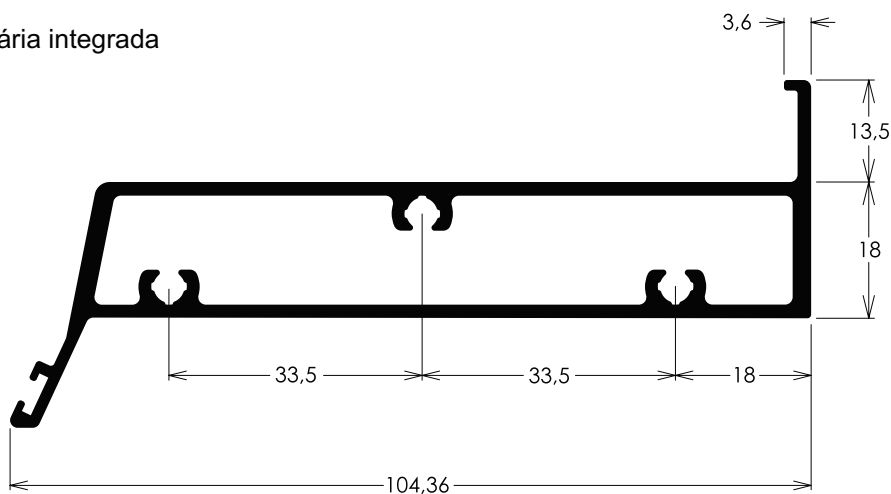

RO165 1,075 kg/m

Marco travessa inferior integrada

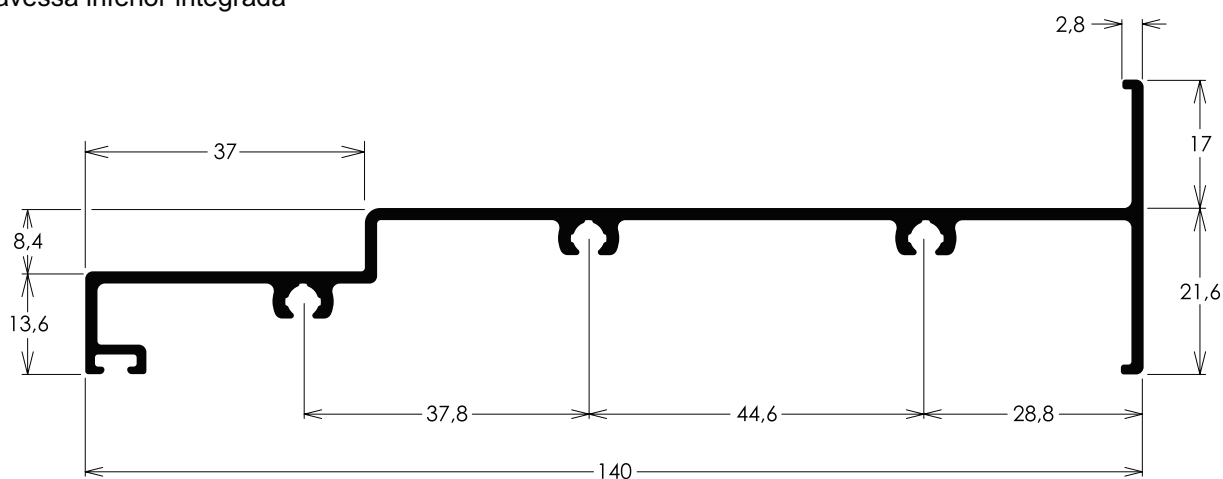

RO169 0,493 kg/m

Trilho integrada

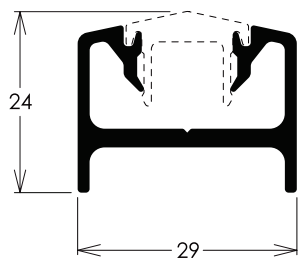

RO170 0,183 kg/m

Trilho integrada

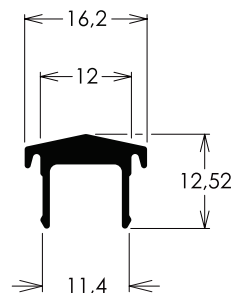

Integrada

RO174 2,503 kg/m

Marco travessa intermediária integrada

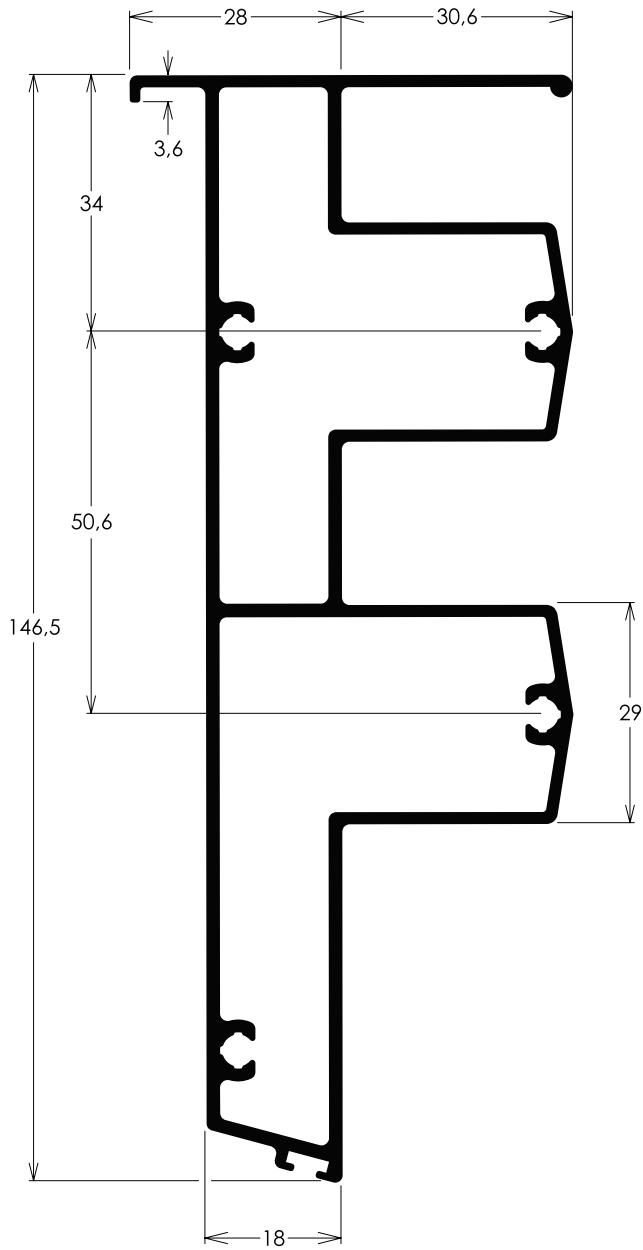

RO167 2,356 kg/m

Marco travessa inferior integrada

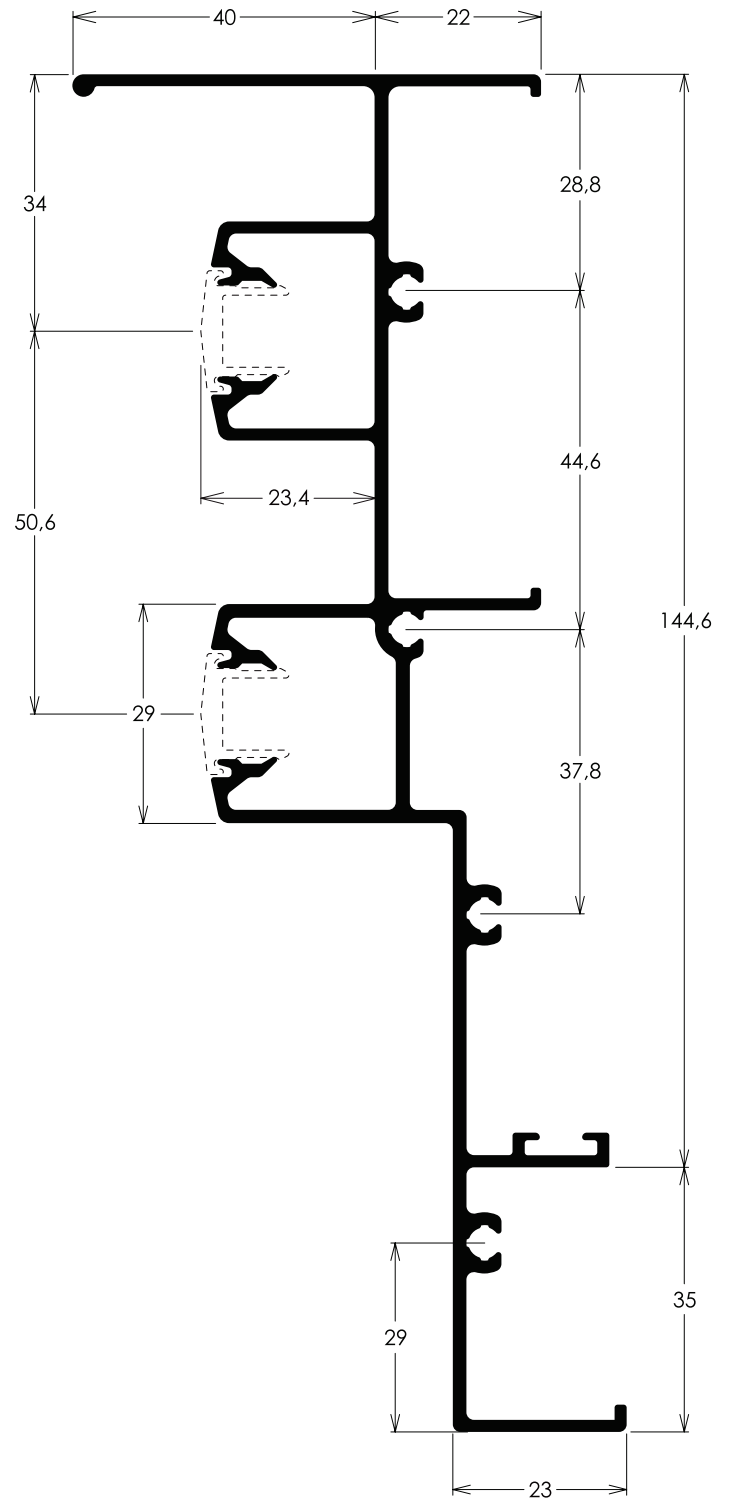

LG169 0,122 kg/m

Complemento perimetral do marco integrada

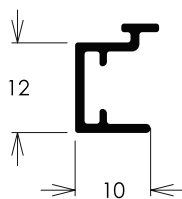

Integrada

MN058 2,497 kg/m

Coluna guia da esteira integrada

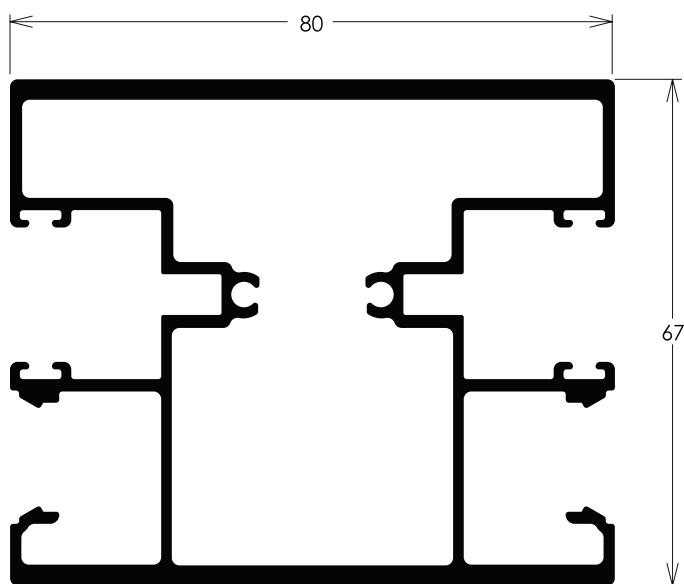

MN027 1,043 kg/m

Guia central da esteira integrada

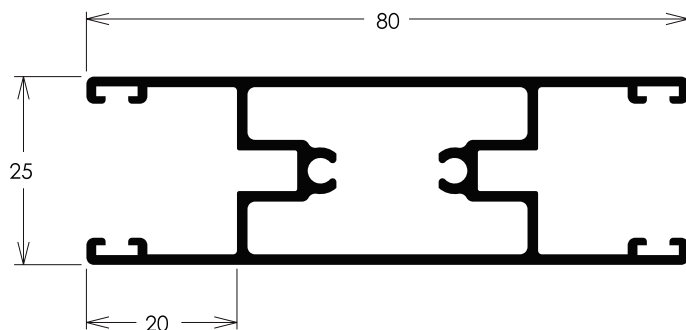

MH006 0,697 kg/m

Guia da esteira integrada

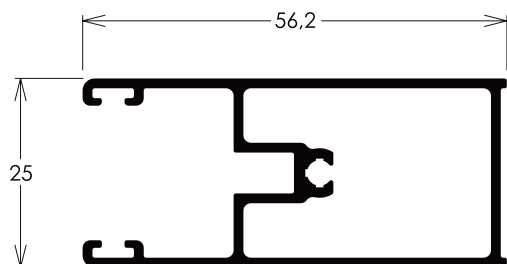

CL022 0,111 kg/m

Tampa da coluna guia

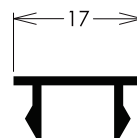

Integrada

MN038 0,884 kg/m

Travessa inferior da folha integrada

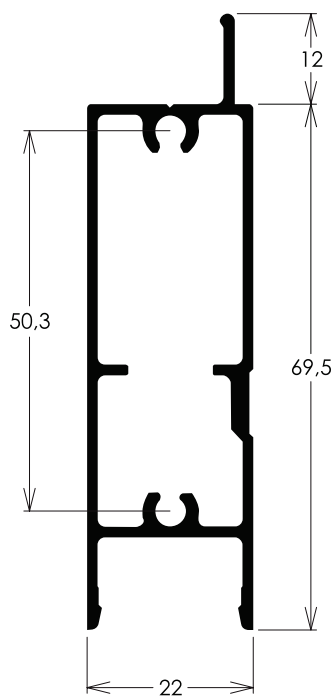

LG179 0,538 kg/m

Complemento integrada

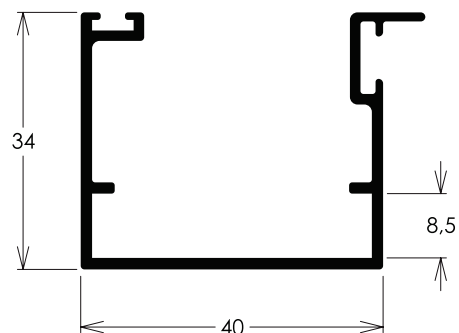

MN019 0,390 kg/m

Marco da folha integrada

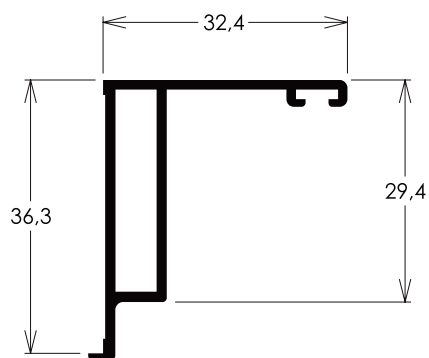

MN022 0,197 kg/m

Complemento inferior da folha integrada

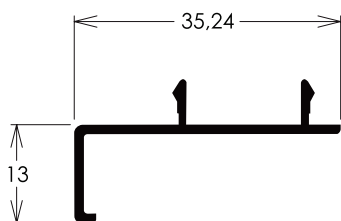

MN057 0,659 kg/m

Lateral guia da folha integrada

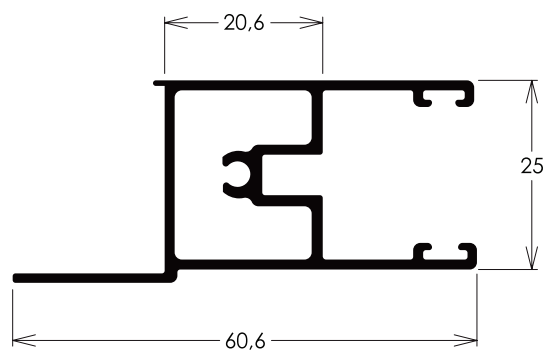

Integrada

MN039 1,400 kg/m
Tampa externa integrada

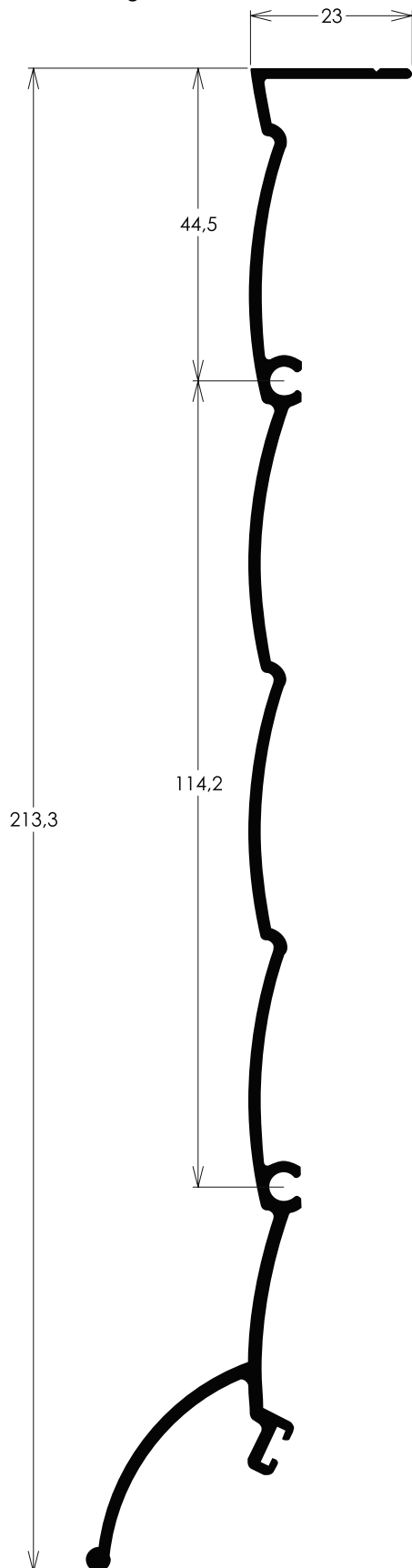

MN015 0,881 kg/m
Tubo octogonal 60 integrada

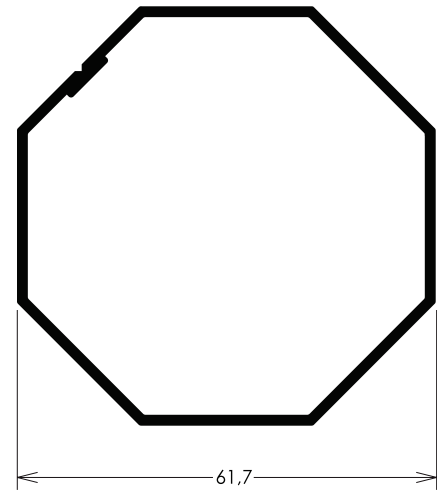

MN055 0,371 kg/m
Terminal da esteira da persiana integrada

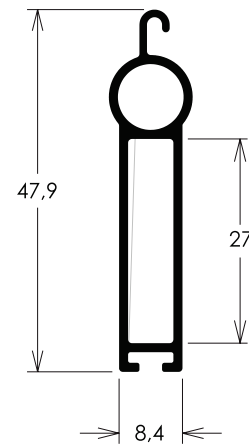

MN034 0,185 kg/m
Barra de comando da folha integrada

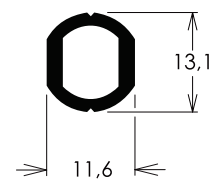

Integrada

LG167 1,598 kg/m
Tampa externa integrada

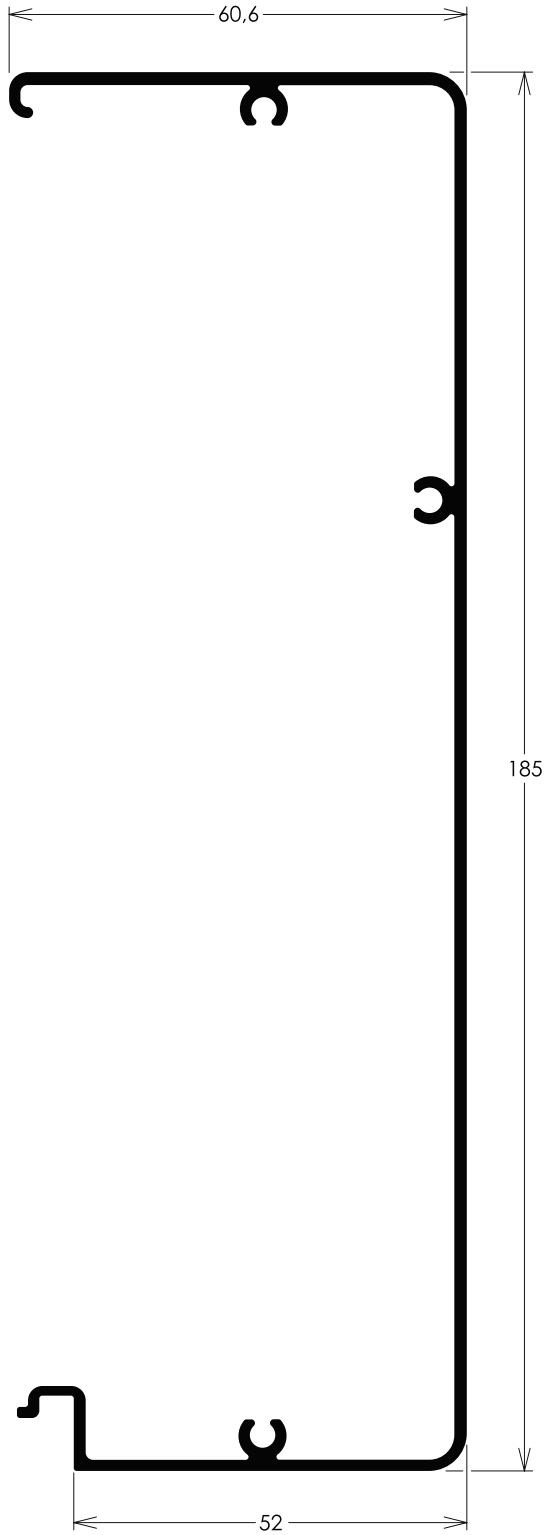

MN031 1,331 kg/m
Tampa externa integrada

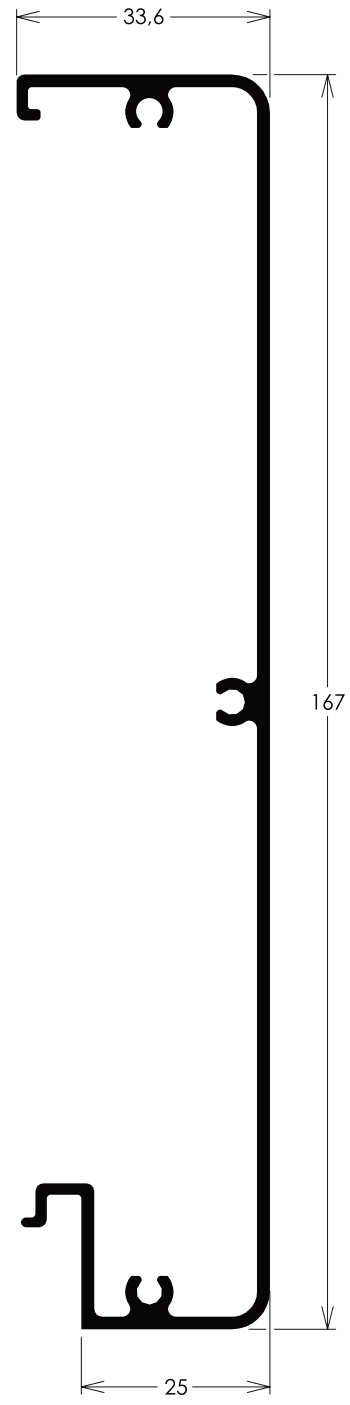

Contramarco, arremate e complementos

RO005 0,748 kg/m

Requadro em alumínio natural

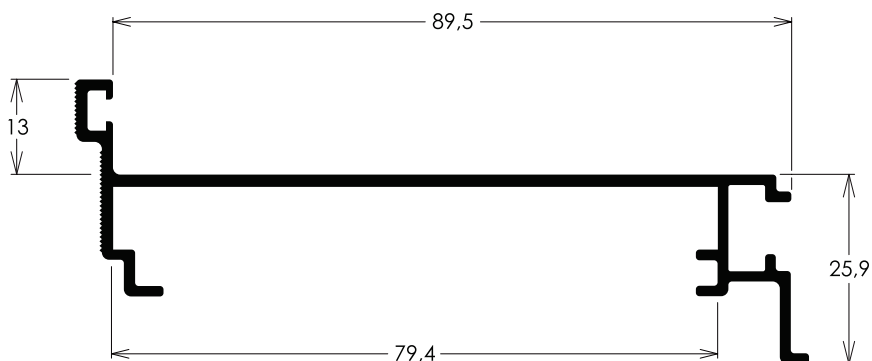

RO006 0,939 kg/m

Travessa inferior do requadro

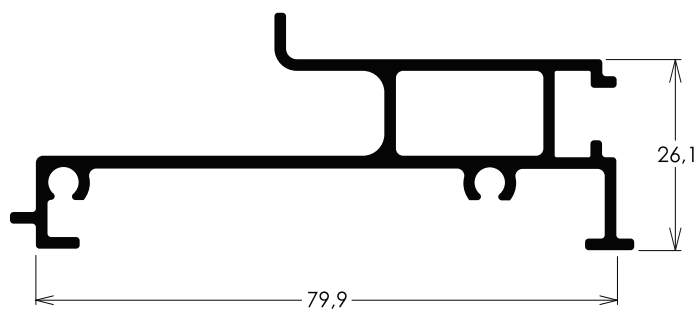

RM029 0,225 kg/m

Arremate de acabamento interno

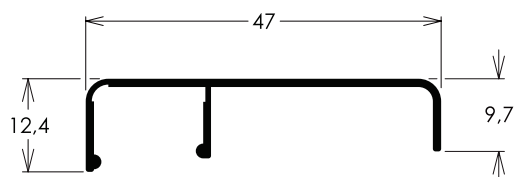

CL011 0,319 kg/m

Conexão cunha

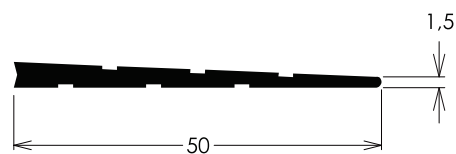

CL006 1,112 kg/m

Conexão macho

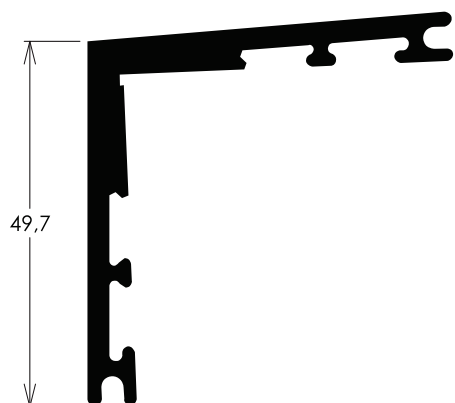

Contramarco, arremate e complementos

RO003 0,602 kg/m

Requadro em alumínio natural

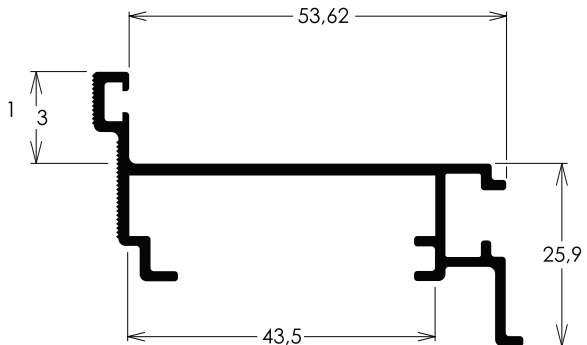

RO001 0,570 kg/m

Requadro em alumínio natural

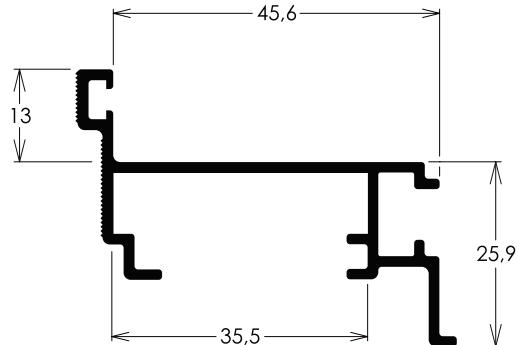

RO004 0,690 kg/m

Travessa inferior do requadro

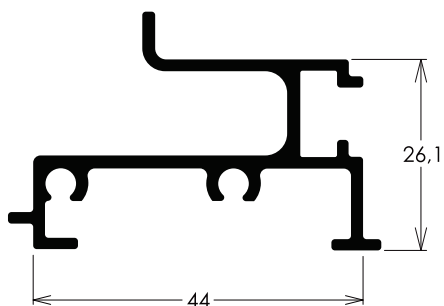

RO002 0,620 kg/m

Travessa inferior do requadro

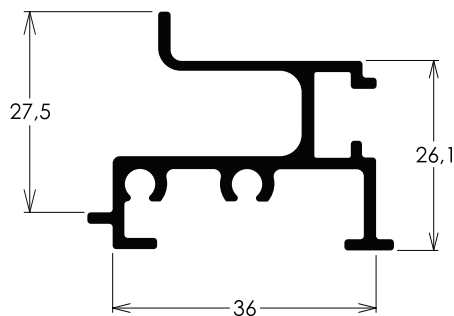

RO007 0,242 kg/m

Arremate de acabamento interno

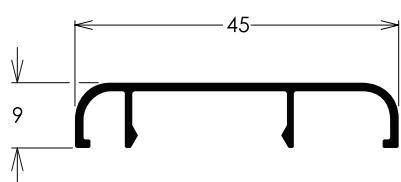

RO016 0,146 kg/m

Barra de comando

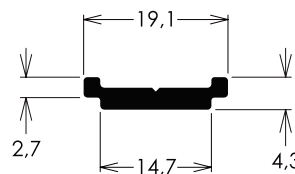

NOTA:
Fornecido anodizado Preto.

RO216 2,155 kg/m

Pingadeira de alvenaria

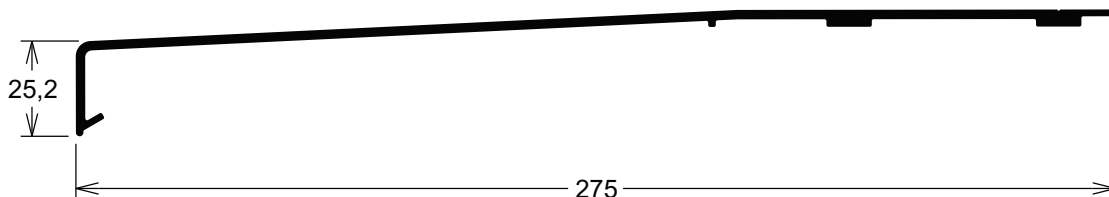

Escala 1:2

Baguetes

RO156 0,210 kg/m

Baguete montante

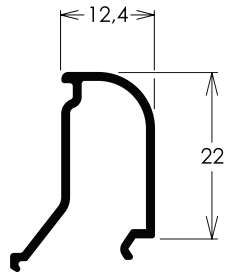

RO157 0,219 kg/m

Baguete travessa

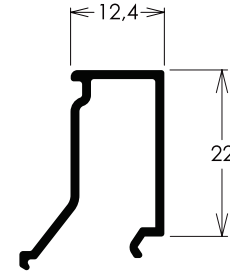

RO022 0,238 kg/m

Baguete montante

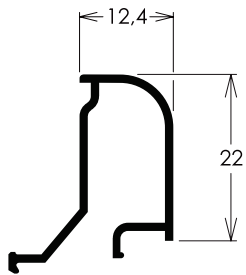

RO023 0,247 kg/m

Baguete travessa

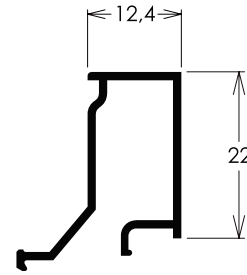

RO024 0,246 kg/m

Baguete montante

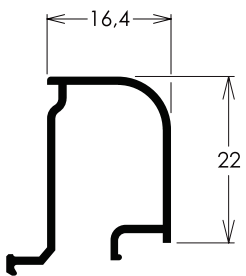

RO025 0,255 kg/m

Baguete travessa

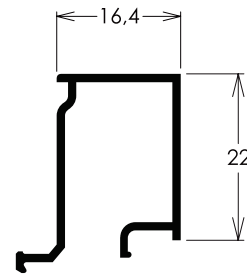

RO026 0,275 kg/m

Baguete montante

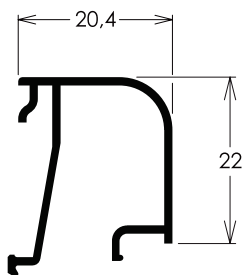

RO027 0,284 kg/m

Baguete travessa

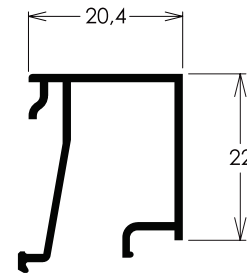

RO018 0,291 kg/m

Baguete montante

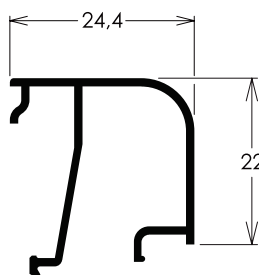

RO019 0,300 kg/m

Baguete travessa

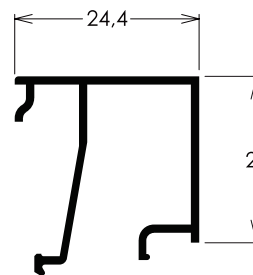

Baguetes

RO020 0,307 kg/m

Baguete montante

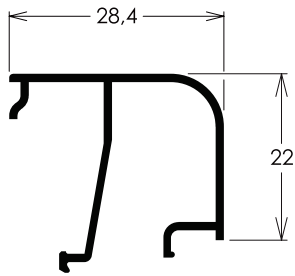

RO021 0,316 kg/m

Baguete travessa

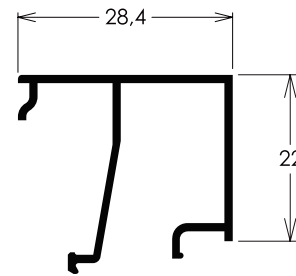

RO037 0,284 kg/m

Baguete montante

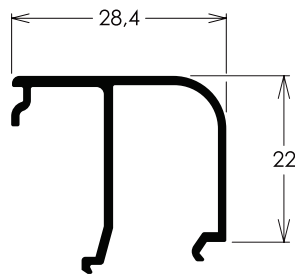

RO038 0,294 kg/m

Baguete travessa

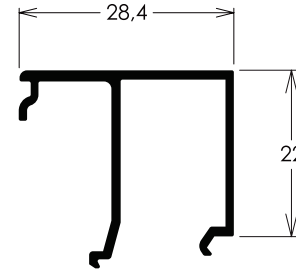

RO029 0,268 kg/m

Baguete montante

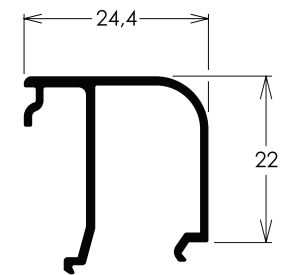

RO030 0,277 kg/m

Baguete travessa

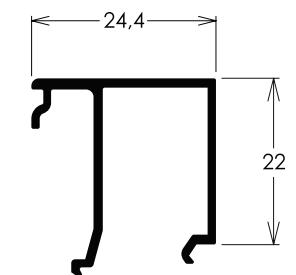

RO105 0,173 kg/m

Baguete

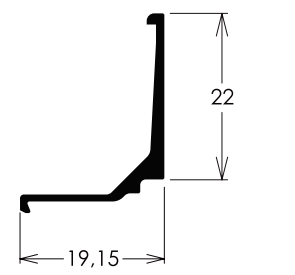

RO028 0,196 kg/m

Baguete

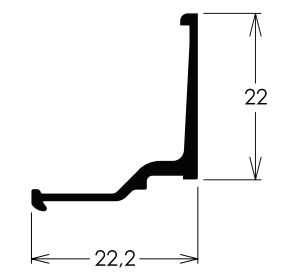

Cód.	Pág.
BAT949	G-34
BRA761	G-22
BRA795	G-08
BRA796	G-09
BRA798	G-09
BRA799	G-09
BRA800	G-22
BRA801	G-22
BRA830	G-08
BRA831	G-08
BUC779	G-21
CAL944	G-32
CAL965	G-19
CAL976	G-37
CHU840	G-14
CHU866	G-14
CHU867	G-15
CHU868	G-15
CHU869	G-15
CHU870	G-15
CHU871	G-15
CHU872	G-15
CIL007	G-19
CIL011	G-35
CIL012	G-35
CON422	G-37
CON427	G-32
CON465	G-03
CON466	G-01
CON468	G-01
CON470	G-44
CON472	G-02
CON473	G-02
CON474	G-04
CON475	G-04
CON476	G-04
CON477	G-04
CON478	G-23
CON479	G-26
CON480	G-27
CON481	G-29
CON482	G-29
CON483	G-35
CON484	G-17
CON485	G-17
CON486	G-29
CON487	G-29
CON488	G-01

Cód.	Pág.
CON488	G-24
CON489	G-01
CON491	G-26
CON492	G-38
CON494	G-35
CON535	G-19
CON538	G-03
CON540	G-06
CON540	G-27
DOB848	G-44
DOB857	G-21
DOB858	G-21
DOB868	G-10
DOB869+KITGN21	G-07
DOB869+KITGN22	G-10
ESP962	G-19
FEC1075	G-11
FEC1077	G-11
FEC1090	G-07
FEC1092	G-05
FEC1093	G-20
FEC1098	G-23
FEC1101	G-26
FEC1105	G-25
FEC1106	G-27
FEC1108	G-41
FEC1211	G-11
FEC464	G-27
FIT206	G-40
FIT211	G-37
FIT214	G-40
FIT222	G-37
FIT260	G-28
FRA819	G-18
FRA823	G-30
GUA005	G-40
GUA132	G-14
GUA157	G-12
GUA209	G-40
GUA289	G-40
GUA320	G-12
GUA329	G-12
GUA337	G-37
GUA338	G-38
GUA342	G-12
GUA360	G-44
GUA408	G-03

Cód.	Pág.
GUA409	G-12
GUA410	G-12
GUA411	G-13
GUA412	G-13
GUA413	G-13
GUA414	G-13
GUA415	G-14
GUA416	G-12
GUA429	G-21
KIT621	G-05
KIT623	G-08
KIT624	G-06
KIT625	G-24
KIT627	G-28
KIT631	G-28
KIT648	G-34
KIT650	G-34
KIT651	G-34
KIT652	G-36
KIT653	G-36
KIT654	G-36
KIT655	G-36
KITGN19	G-06
KITGN19	G-27
KITGN22+DOB869	G-07
KITGN25	G-26
MAC1007	G-20
MAC1008	G-20
MAC1009	G-35
MAC1038	G-20
MAC1039	G-35
MAC1040	G-35
NYL042	G-39
NYL370	G-39
NYL382	G-39
NYL434	G-42
NYL435	G-41
NYL436	G-43
NYL437	G-43
NYL438	G-42
NYL446	G-25
NYL481	G-39
NYL482	G-02
NYL482	G-25
NYL484	G-03
NYL489	G-25
NYL491	G-17

CON489

Conexão com parafuso 16,8mm x 29,9mm
Alumínio Natural

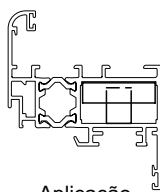
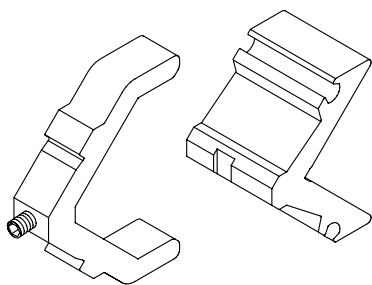
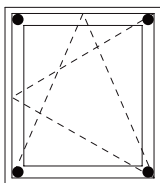

Aplicação

CON468

Conexão com parafuso 16,8mm x 36,1mm
Alumínio Natural

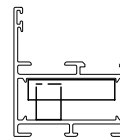
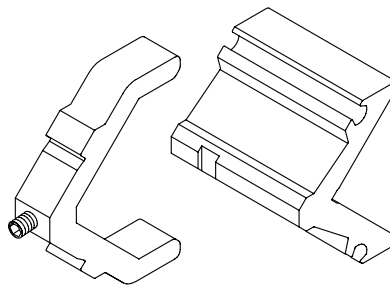
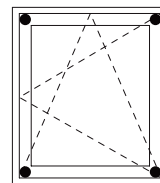

Aplicação

CON466

Conexão com parafuso 16,8mm x 20,3mm
Alumínio Natural

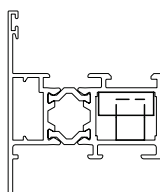
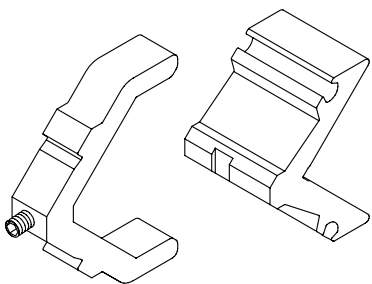
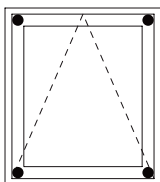

Aplicação

CON488

Conexão com parafuso 16,8mm x 36,1mm
Alumínio Natural

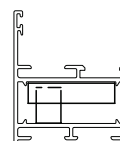
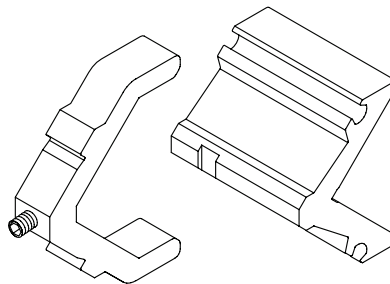
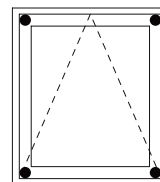

Aplicação

CON472

Conexão de alinhamento 14mm x 3mm
Alumínio Natural

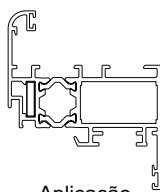
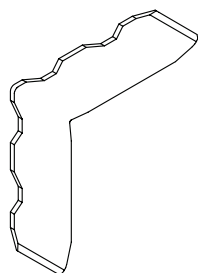
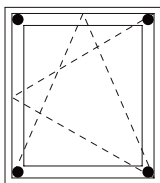

Aplicação

CON473

Conexão de alinhamento 22mm x 3mm
Alumínio Natural

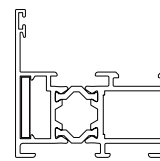
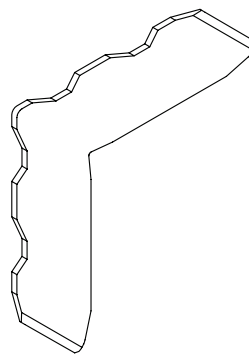
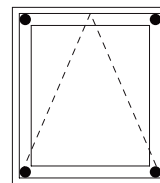

Aplicação

NYL482

Conexão de alinhamento
Nylon preto

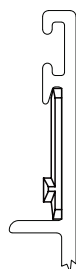
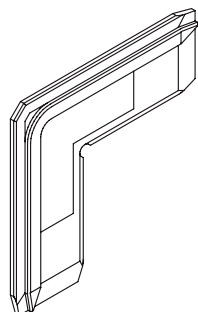
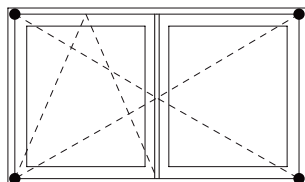

Aplicação

NYL556

Protetor de saída d'água
Nylon preto

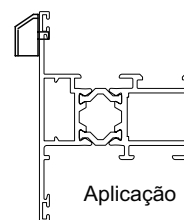
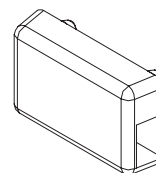
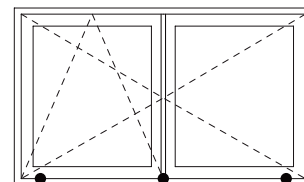

Aplicação

NYL484

Tampa reversível interna
Nylon Preto

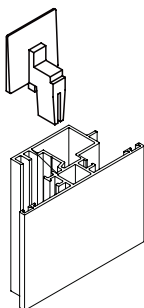
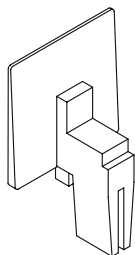
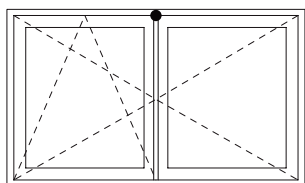

Aplicação

GUA408

Tampa reversível externa
EPDM Preto

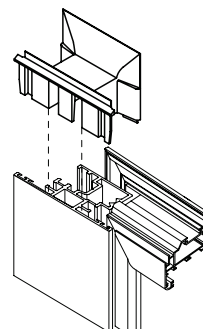
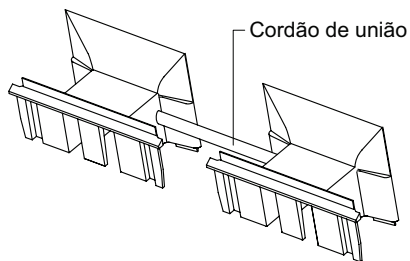
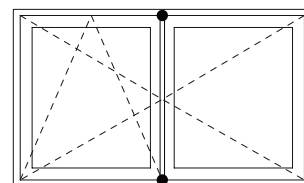

Aplicação

CON538

Contrafecho
Zamak Natural

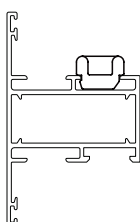
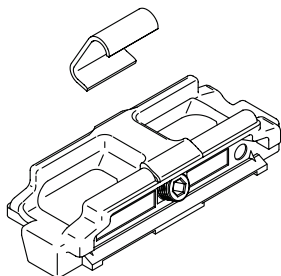
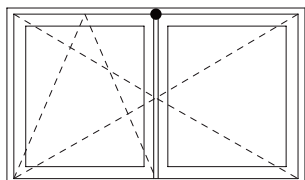

Aplicação

CON465

Trava central com regulamento
Janela de Giro
Zamak Natural

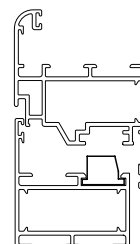
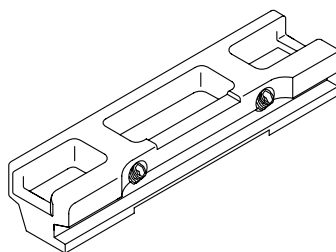
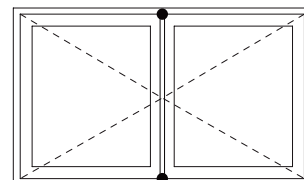

Aplicação

CON474

Fixador de montante 9,8 mm
Alumínio Natural

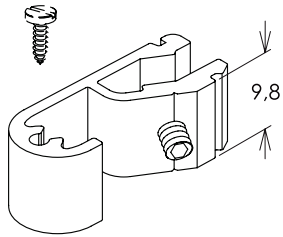
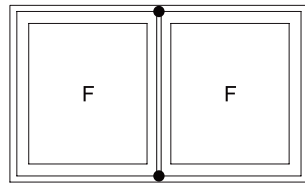

Ver montagem

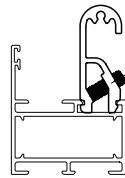

Aplicação

CON475

Fixador de montante 16,6 mm
Alumínio Natural

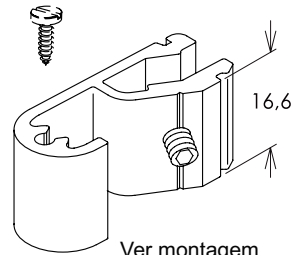
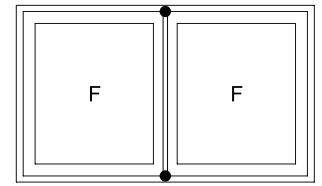

Ver montagem

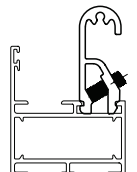

Aplicação

CON476

Fixador de montante 24,6 mm
Alumínio Natural

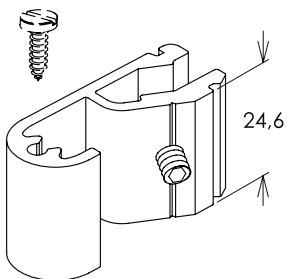
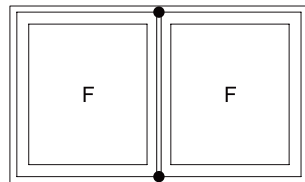

Ver montagem

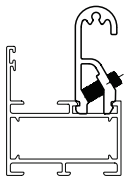

Aplicação

CON477

Fixador de montante 41,6 mm
Alumínio Natural

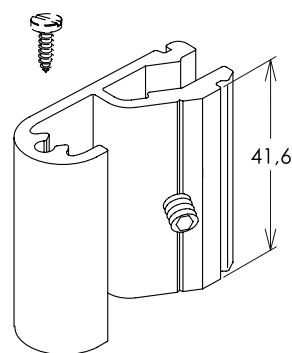
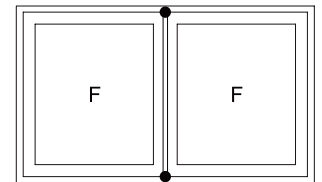

Ver montagem

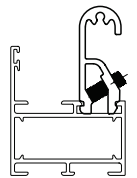

Aplicação

KIT621

Sistema de Travamento
 Janela de Giro
 Zamak Natural

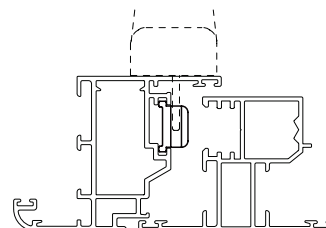
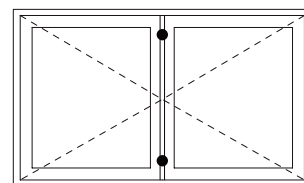
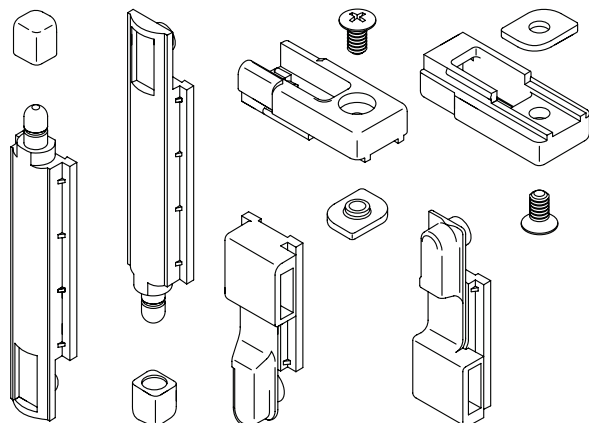

Aplicação

FEC1092

Fecho tipo gatilho
 Janela de Tombar
 Alumínio Branco ou Preto

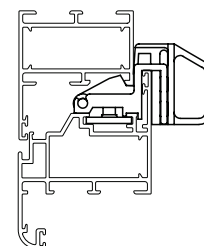
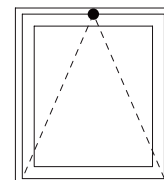
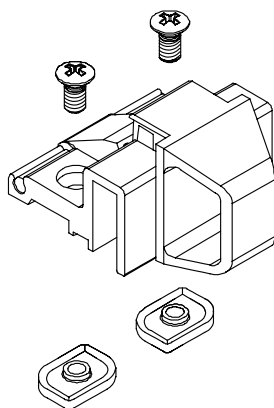

Aplicação

KIT624

Comando de transmissão angular
 Janela Reversível
 Zamak Natural

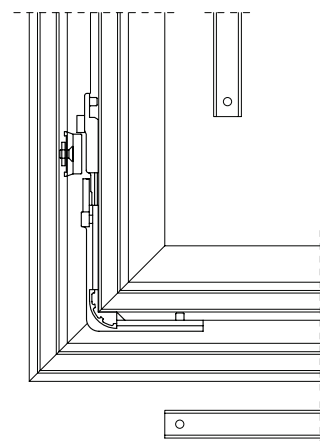
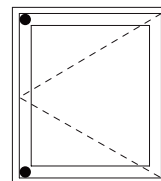
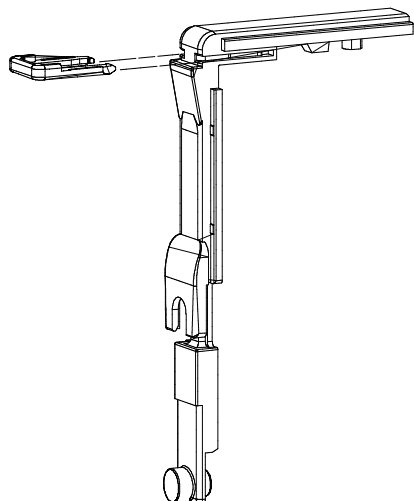

Aplicação

NOTA:

Kit aplicado quando L for maior que 1100mm e H maior que 1200mm.

TRA018

Trava complementar ajustável
 Zamak Natural

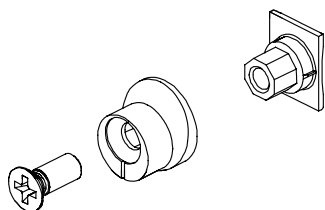
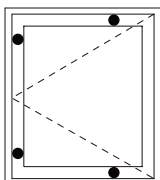

CON540

Trava Ajustável
 Zamak Natural

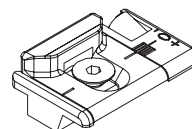
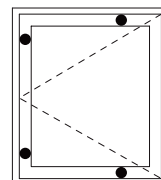

DOB869 + KITGN21

Kit abrir e tombar 1 folha
 Capacidade: 80 kg
 Alumínio Branco ou Preto
 Zamak Natural

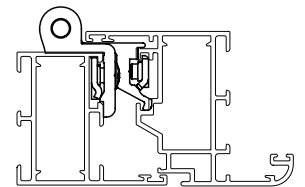
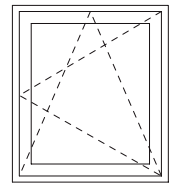
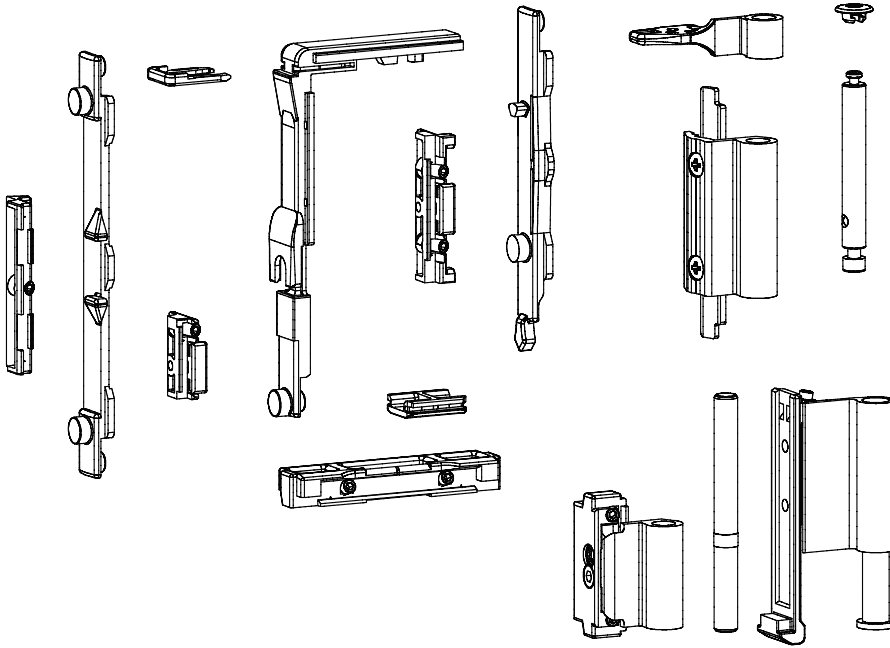

Aplicação

FEC1090

Kit do fecho central com haste
 2ª Folha Oscilo Batente e folha de Giro
 Zamak Natural

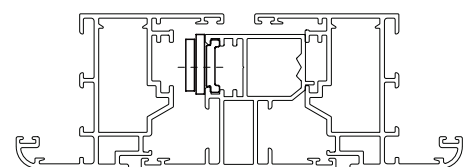
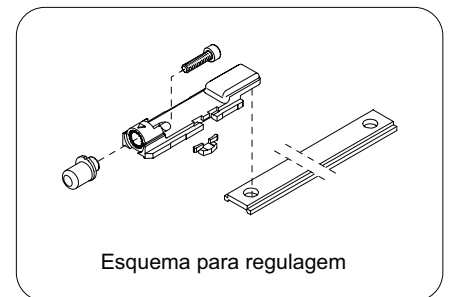
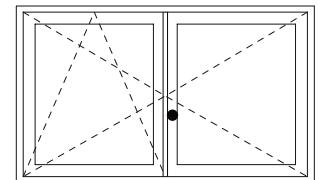
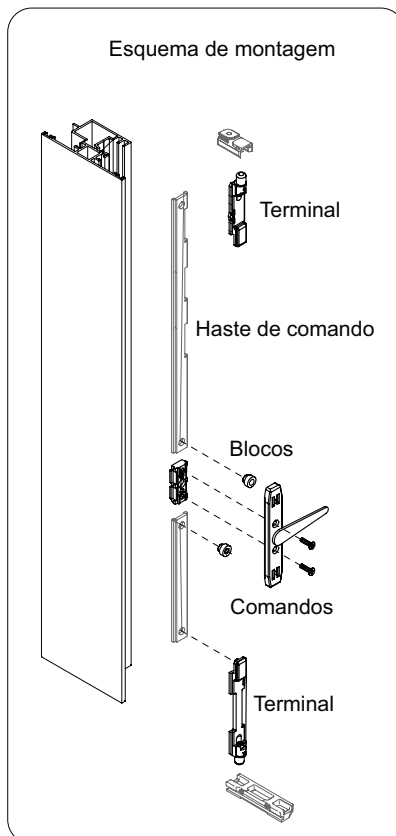
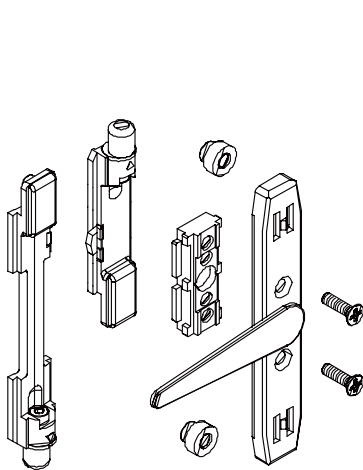

Aplicação

BRA795

Braço complementar da folha
 Janela Oscilo Batente
 Zamak Natural

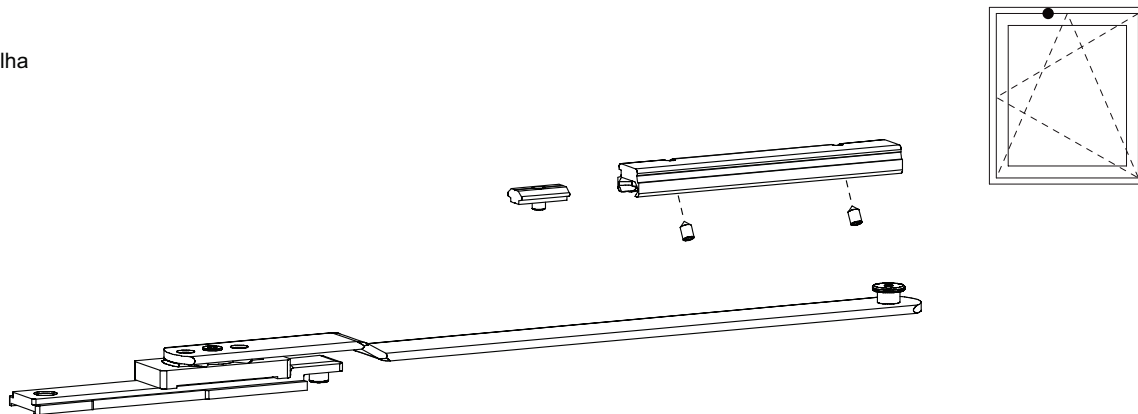

NOTA:
 Braço aplicado em folhas com largura acima de 1000 mm.

Aplicação: ver página 131

KIT623

Kit complementar do mecanismo base
 Janela Oscilo Batente
 Zamak Natural

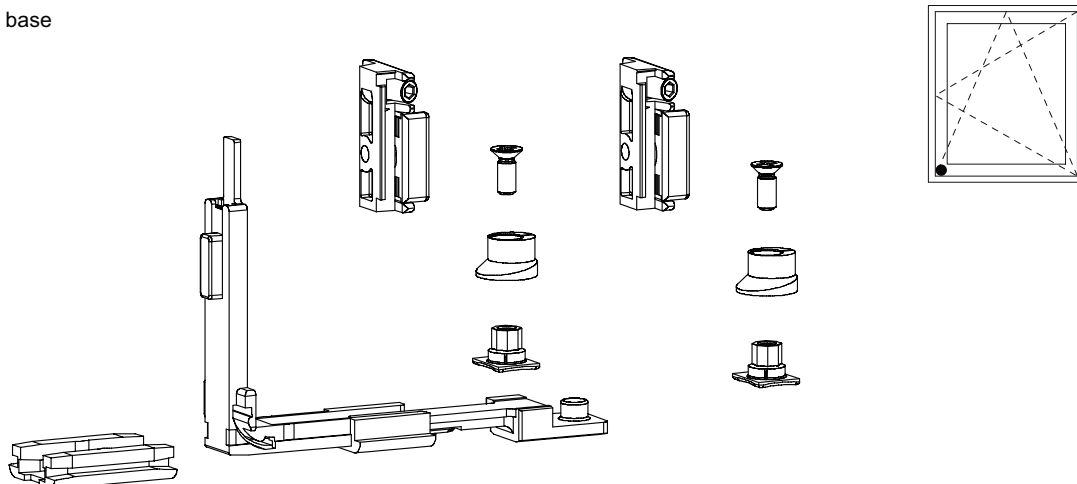

NOTA:
 Kit aplicado quando L for maior que 1000mm e H maior que 1200mm.

Aplicação: ver página 131

	Dimensão	Largura da Folha
BRA830	225	Min: 390 Max: 544

Braço Tipo 1

Zamak Natural

	Dimensão	Largura da Folha
BRA831	365	Min: 545 Max: 1700

Braço Tipo 2

Zamak Natural

Capacidade: 80 kg

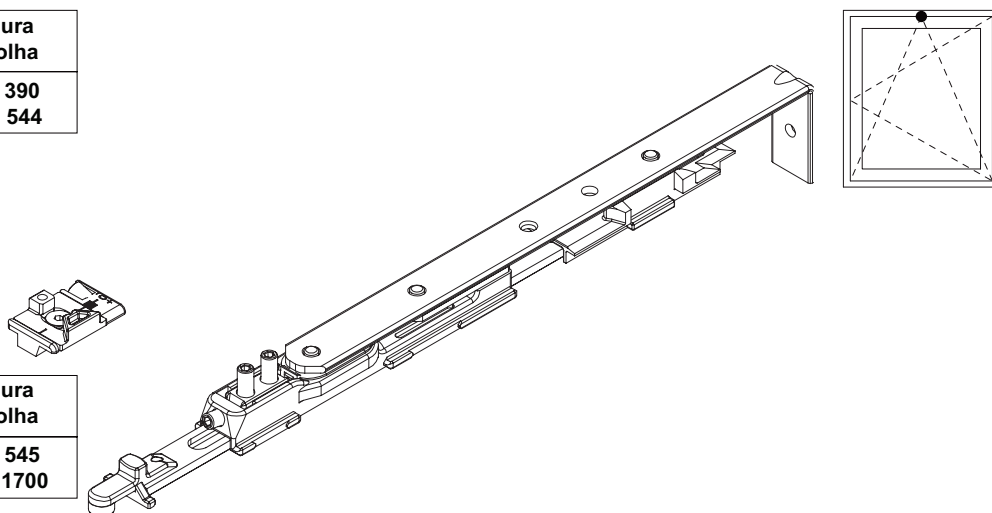

Aplicação: ver página 131

BRA799

Braço limitador de abertura da folha
 Janela Oscilo Batente 2 folhas
 Zamak Natural

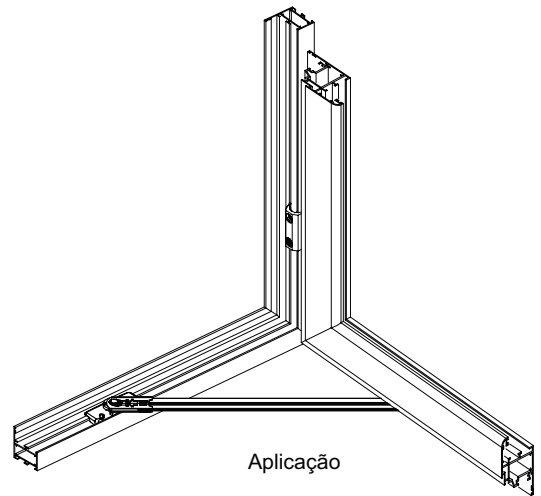
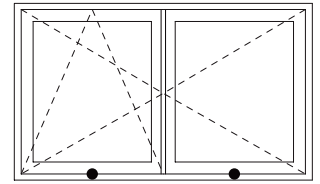
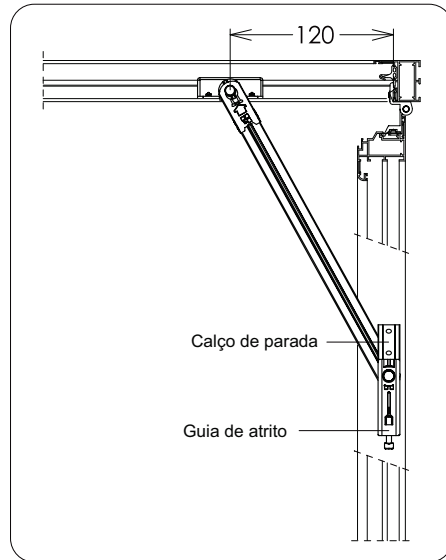
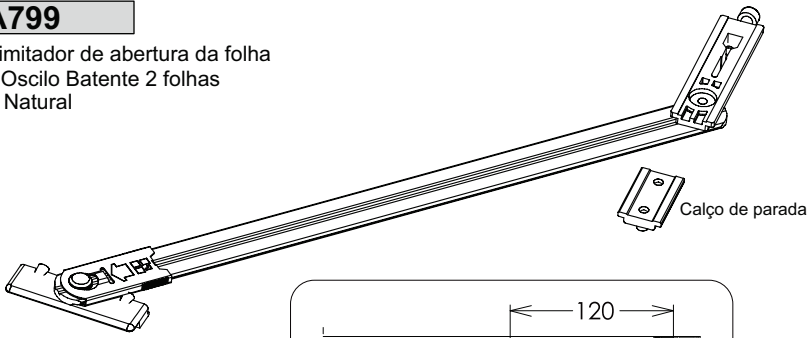

NOTA:
 Braço aplicado em folhas com largura acima de 450mm.

	Dimensão mm	Altura da folha	Carga Máxima
BRA798	150	Min: 300 Max: 600	70kg
BRA796	250	Min: 601 Max: 1500	70kg

Compasso

Janela de Tombar
 Alumínio Branco ou Preto

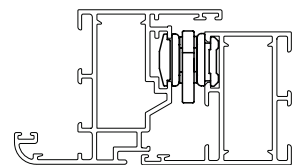
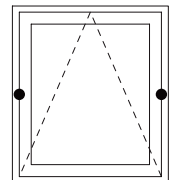
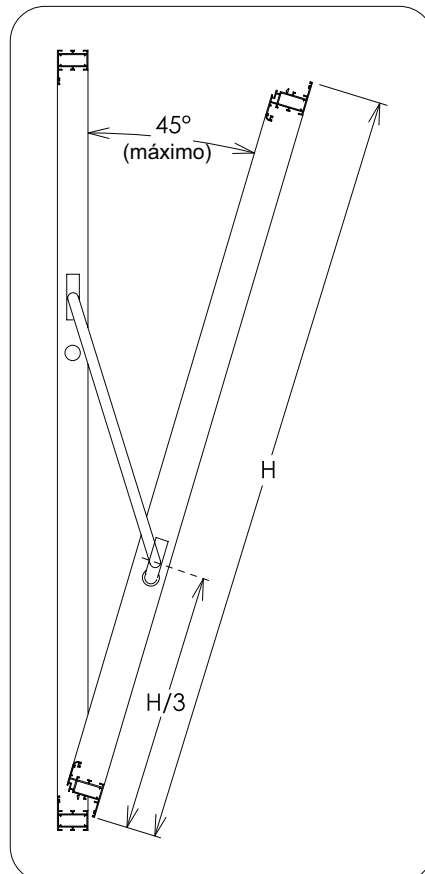
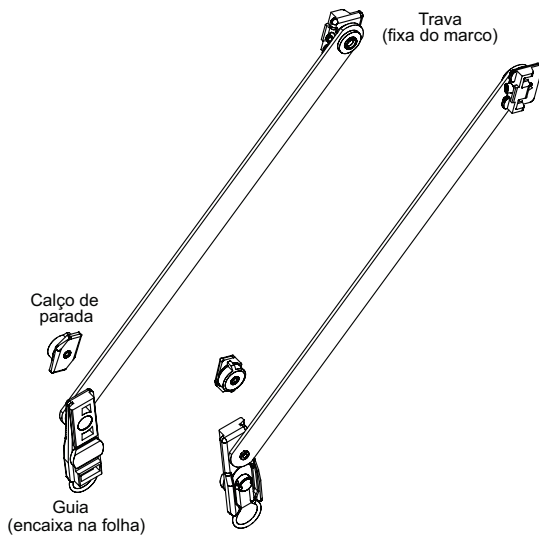

Aplicação

DOB869 + KITGN22

Dobradiça Oscilo Batente
Alumínio Branco ou Preto

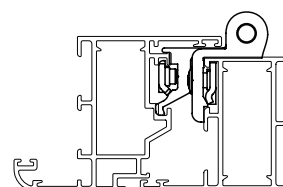
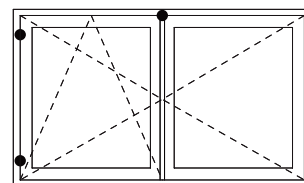
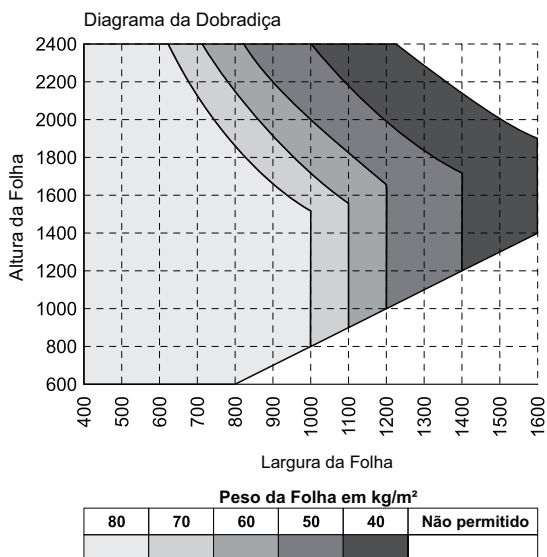
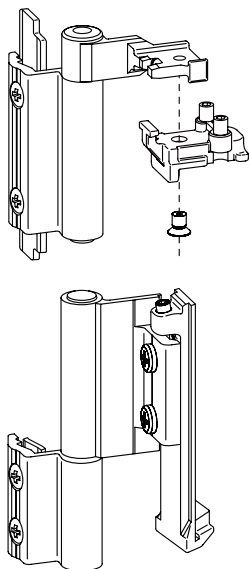

Aplicação

NOTA:
Peso máximo da folha = 80kg.

DOB868

Dobradiça 3 abas
Alumínio Branco ou Preto

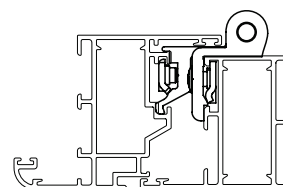
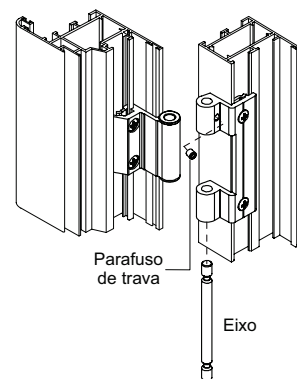
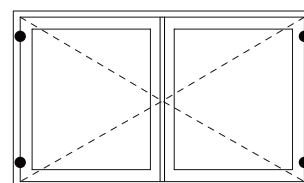
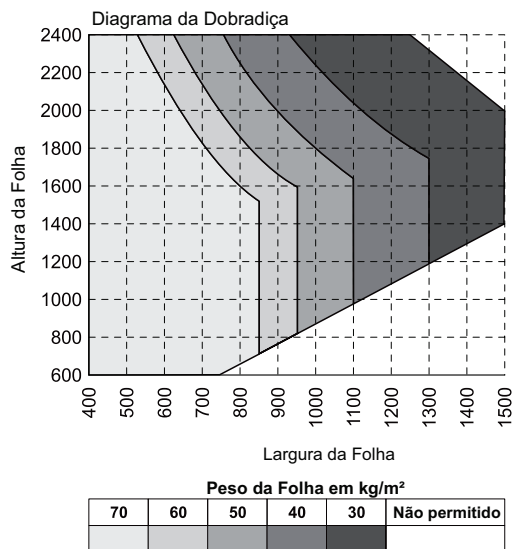
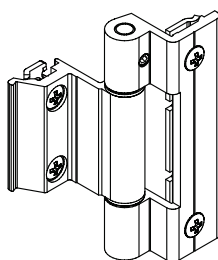

Aplicação

NOTA:
Aplicação em folhas maiores que 1000mm;
Peso máximo da folha = 90kg.

o

FEC1075

Fecho Cremona modelo Euro
Janela de Giro
Alumínio Branco ou Preto

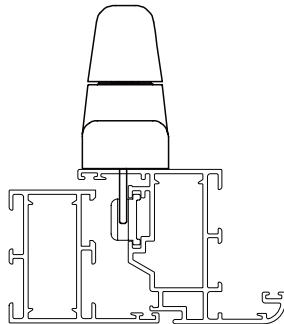
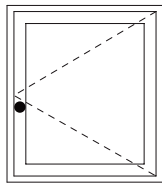
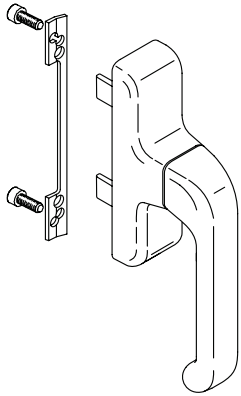

Aplicação

FEC1077

Fecho Cremona modelo Prima
Janela de Giro
Alumínio Branco ou Preto

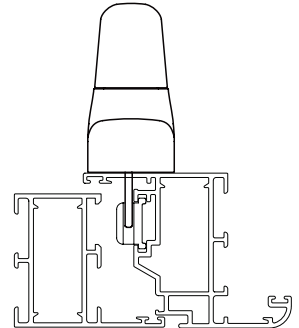
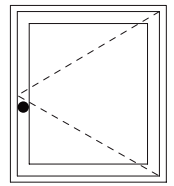
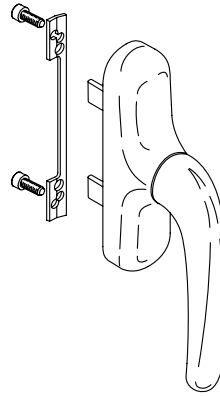

Aplicação

FEC1211

Fecho Cremona modelo Euro
Janela Oscilo Batente
Alumínio Branco ou Preto

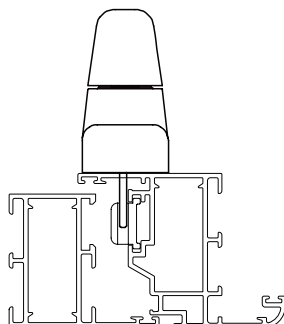
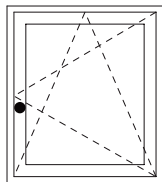
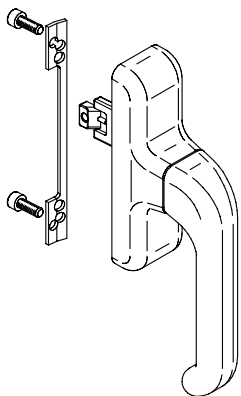

Aplicação

FEC1211

Fecho Cremona modelo Prima
Janela Oscilo Batente
Alumínio Branco ou Preto

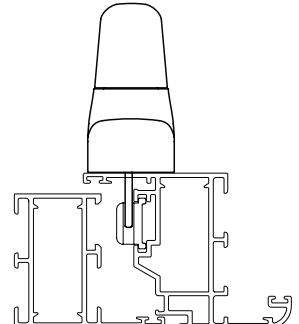
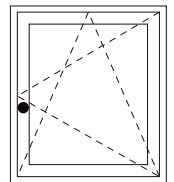
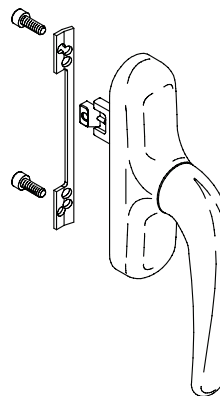

Aplicação

GUA320

Guarnição do Contramarco
EPDM Preto

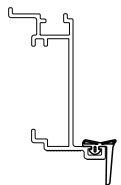
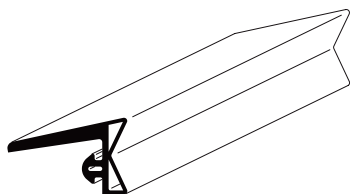

Aplicação

GUA329

Guarnição Inferior do Marco
EPDM Preto

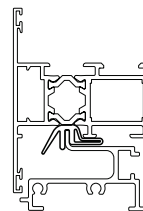
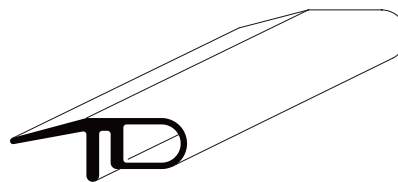

Aplicação

GUA409

Guarnição pré-câmara
EPDM Preto

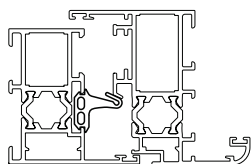
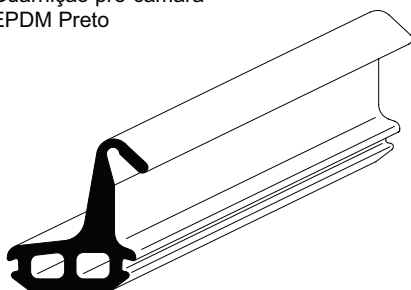

Aplicação

GUA416

Guarnição da Folha
EPDM Preto

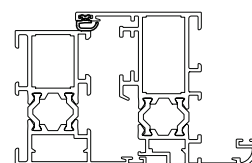
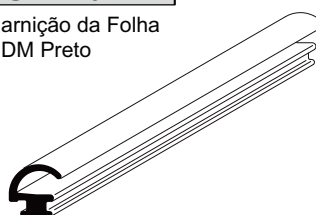

Aplicação

GUA157

Guarn. ades. asponjosa 11 x 6,4 mm
Preta

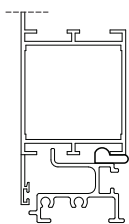
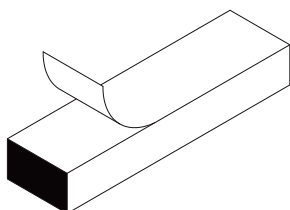

Aplicação

GUA342

Garnição lateral do marco
Preta

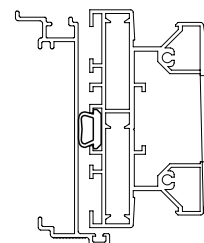
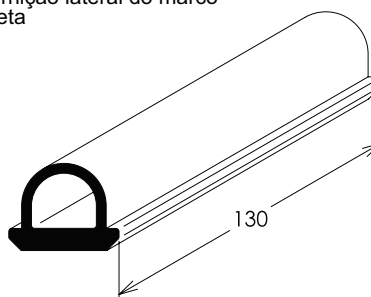

Aplicação

GUA410

Guarnição da Folha
EPDM Preto

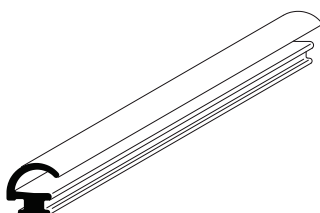

TAR001

Tarucel diâmetro de 06 mm

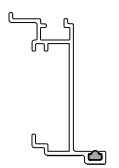
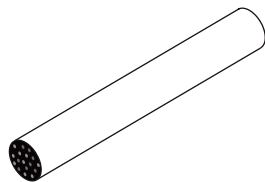

Aplicação

TAR002

Tarucel diâmetro de 08 mm

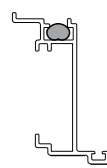
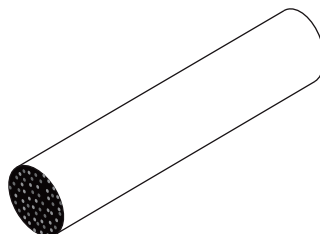

Aplicação

GUA411

Guarnição interna para vidro
EPDM Preto

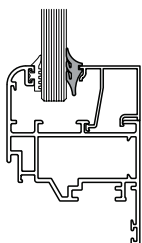
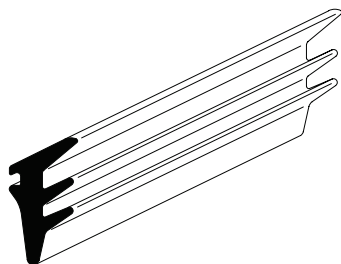

Aplicação

NOTA:
Consultar página 82.

GUA413

Guarnição externa para vidro
EPDM Preto

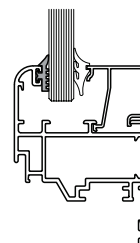
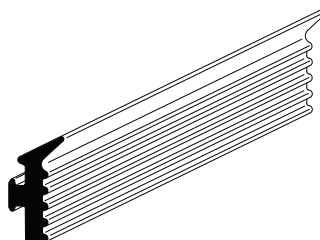

Aplicação

NOTA:
Consultar página 82.

GUA412

Guarnição interna para vidro
EPDM Preto

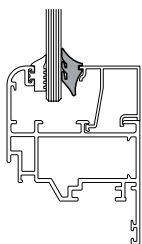
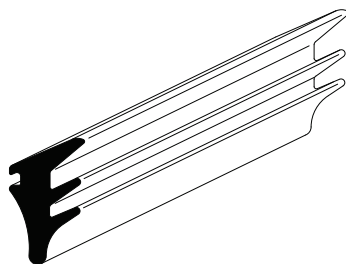

Aplicação

NOTA:
Consultar página 82.

GUA414

Guarnição externa para vidro
EPDM Preto

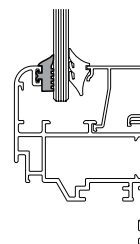
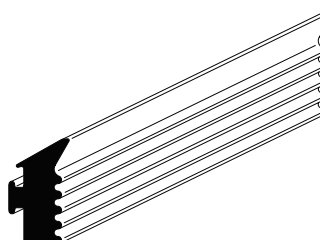

Aplicação

NOTA:
Consultar página 82.

GUA415

Guarnição de ângulo
pré-câmara
EPDM Preto

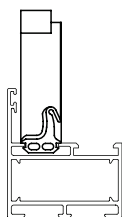
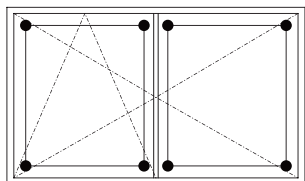
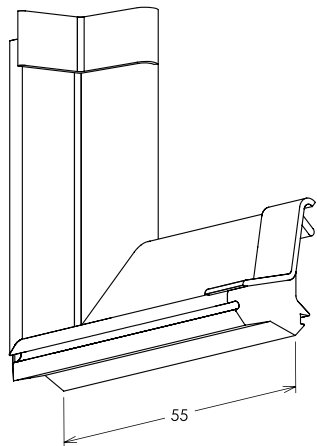

Aplicação

GUA132

Guarnição
PVC

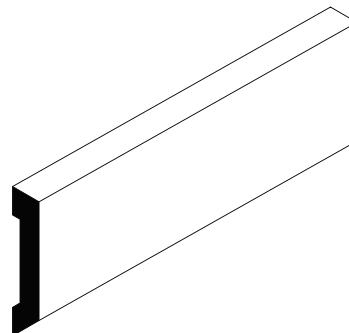

CHU866

Chumbador
Alumínio Natural

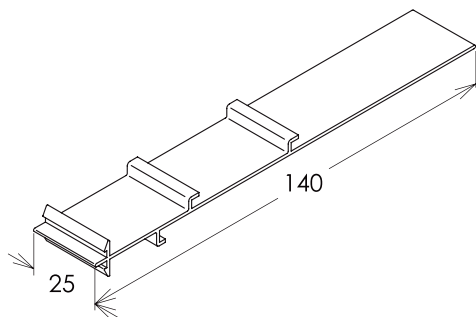

CHU840

Chumbador
Alumínio Natural

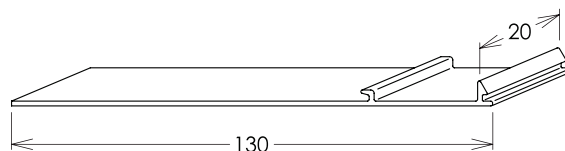

CHU871

Chumbador
Aço Zincado

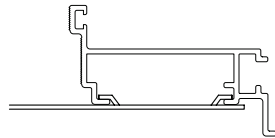
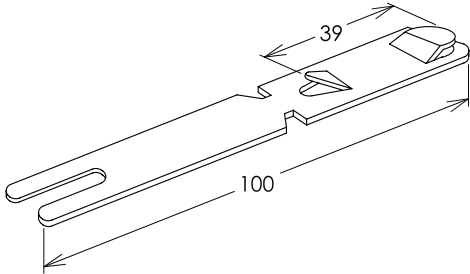

Aplicação

CHU872

Chumbador
Aço Zincado

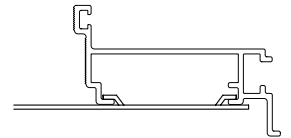
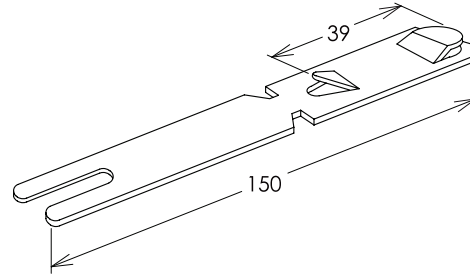

Aplicação

CHU867

Chumbador
Aço Zincado

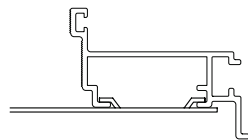
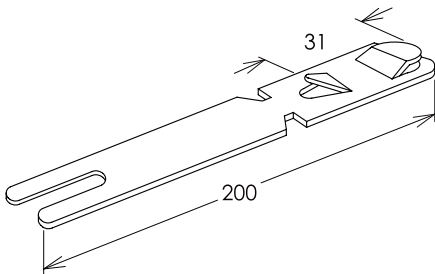

Aplicação

CHU868

Chumbador
Aço Zincado

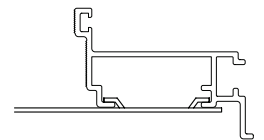
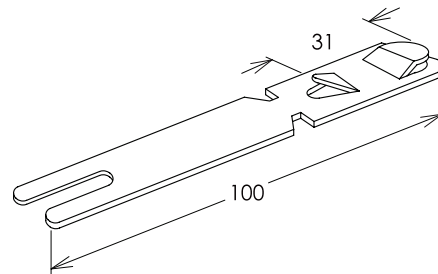

Aplicação

CHU869

Chumbador
Aço Zincado

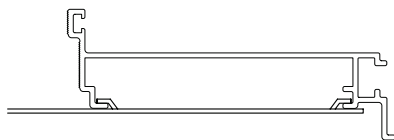
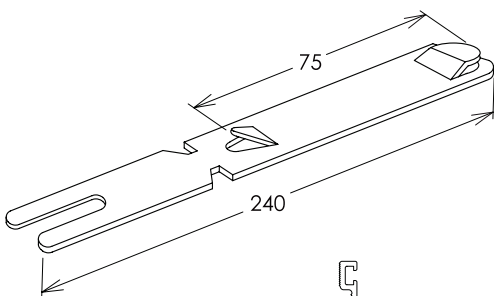

Aplicação

CHU870

Chumbador
Aço Zincado

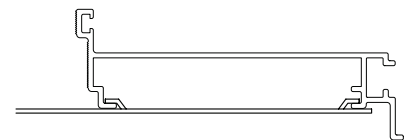
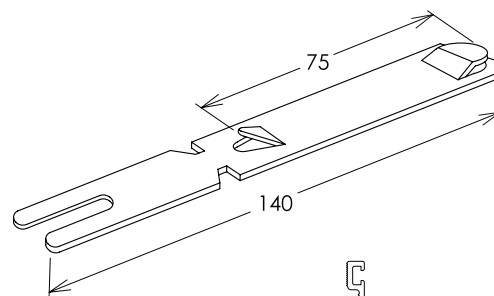

Aplicação

PRE978

Presilha de fixação
Alumínio Natural

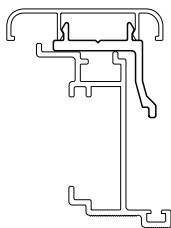
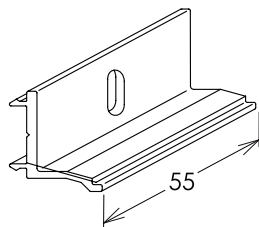

Aplicação

PAR1008

Parafuso Allen M4 x 10mm
Aço Inox

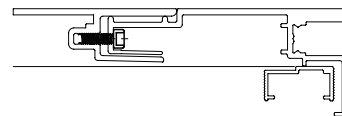
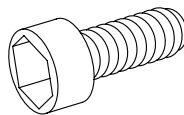

Aplicação

PAR428

Par. A/A cab. panela ponta piloto 4,8 x 32 mm
Fenta combinada
Aço inox

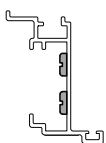
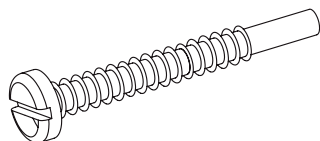

Aplicação

PAR1069

Par. A/A cab. panela 4,2 x 38 mm
Fenta comum
Aço inox

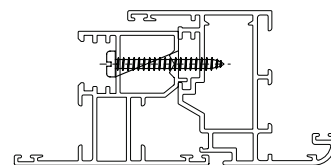
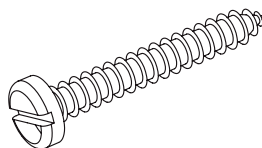

Aplicação

PAR715

Parafuso sextavado com porca
WW Ø 6,35 x 12,7mm
Aço Inox

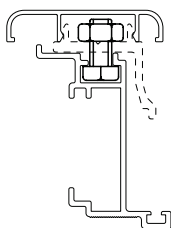
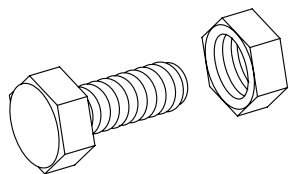

Aplicação

PAR434

Par. A/A cab. panela 3,9 x 9,5 mm
Fenta comum
Aço inox

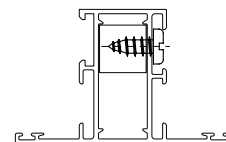

Aplicação

CON484

Conexão com parafuso 41,8mm x 20,3mm
Alumínio Natural

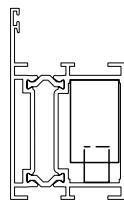
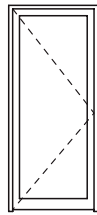
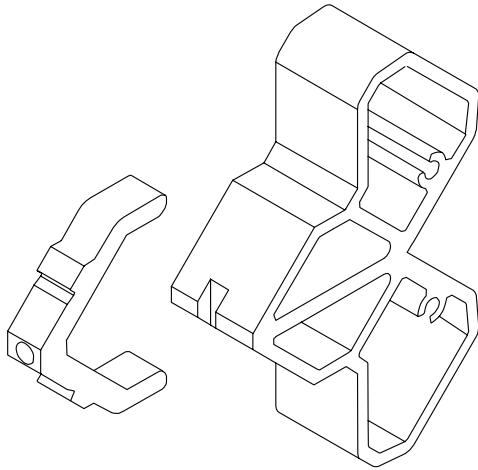

Aplicação

CON483

Conexão com parafuso 41,8mm x 41,9mm
Alumínio Natural

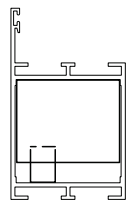
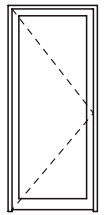
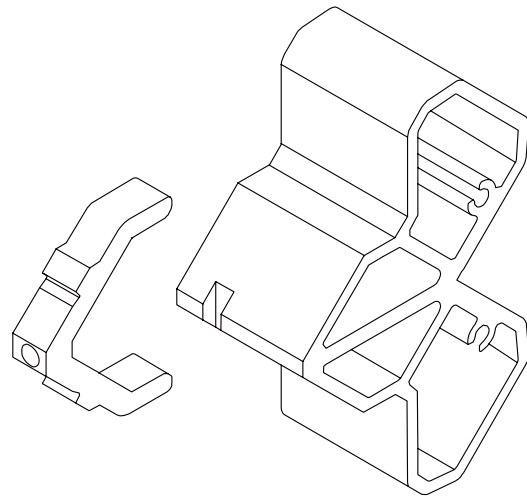

Aplicação

CON485

Conexão de alinhamento
41,8mm x 3mm
Alumínio Natural

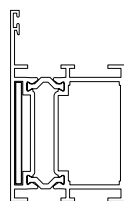
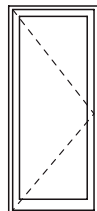
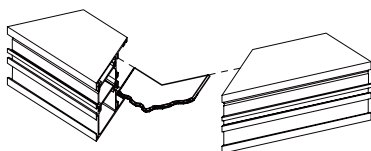
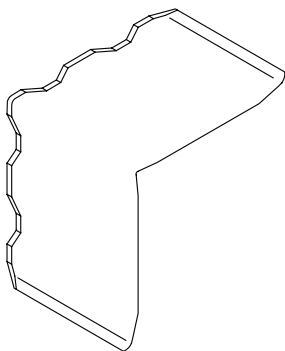

Aplicação

NYL491

Tampa central reversível
Porta de giro
Nylon Preto

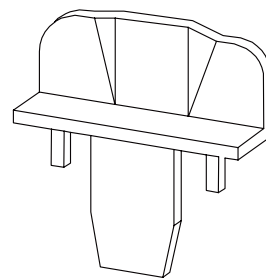
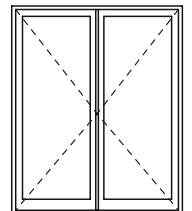

FRA819

Fechadura para porta de Giro
Aço Inox

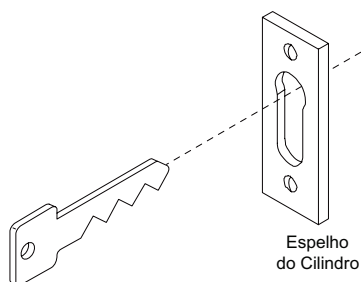
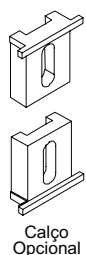
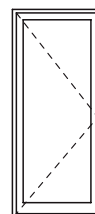

Calço CAL938

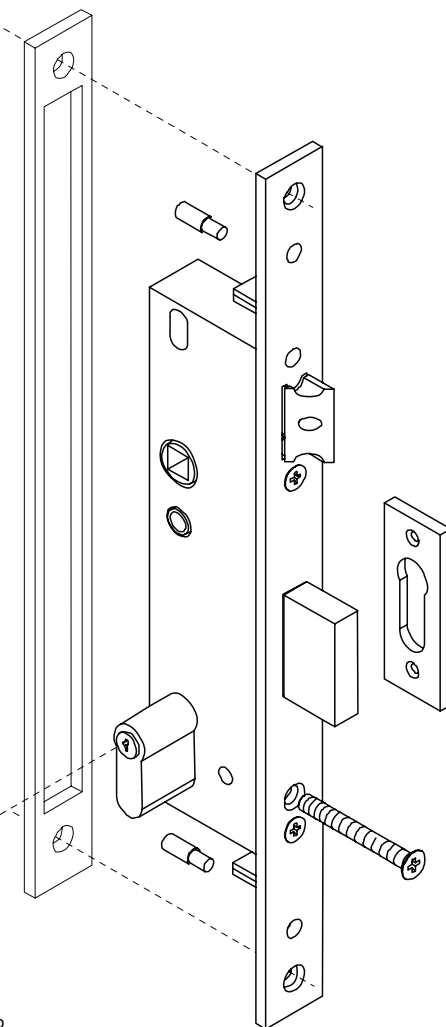

Contratesta CON415

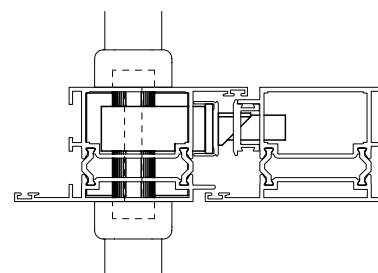
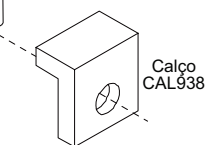

Aplicação

NOTA:
Cilindro, contratesta e calços CAL938 não acompanham a fechadura.
Ver página 74.

CAL965

Calço da fechadura
Alumínio preto, branco e fosco

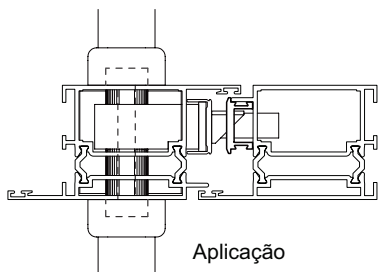
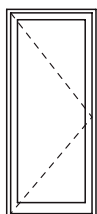
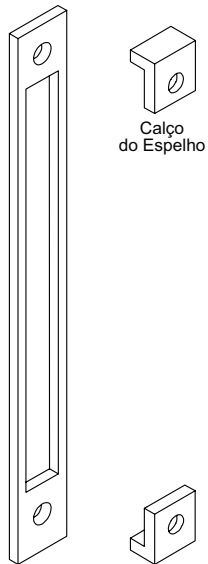

CON535

Contratesta para fechadura
Aço inox

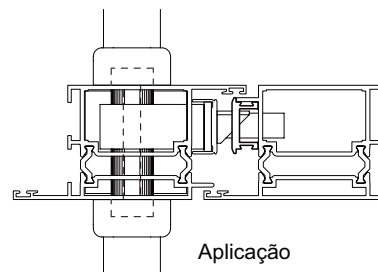
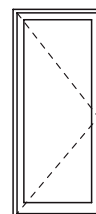
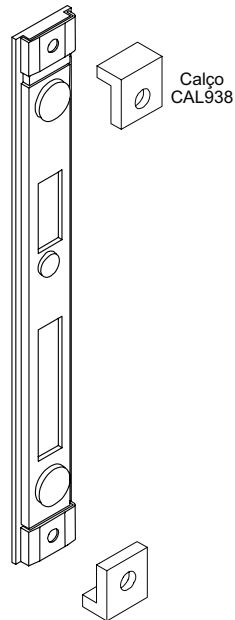

ESP962

Espelho para cilindro
Alumínio Pintado e Nylon

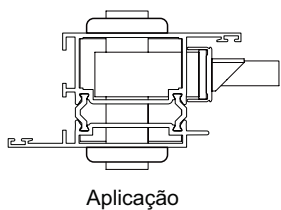
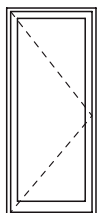
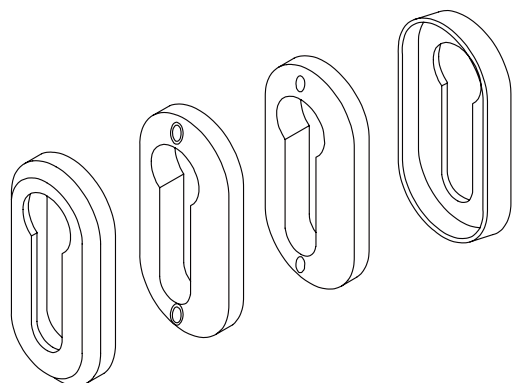

CIL007

Cilindro 72mm
para fechadura FRA819
Latão

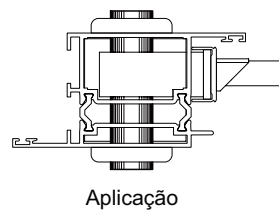
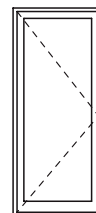
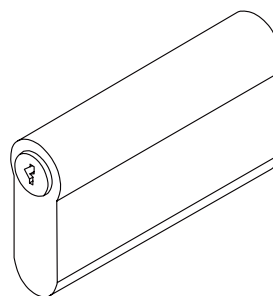

FEC1093

Fecho Unha - Porta de giro
Nylon e Zamak Preto

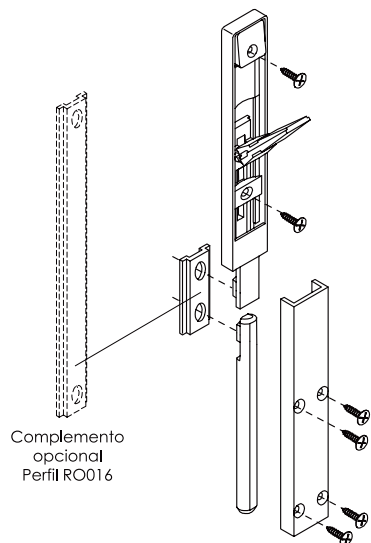

Complemento
opcional
Perfil RO016

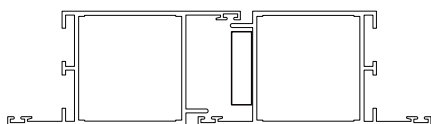
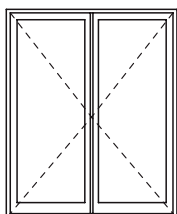

Aplicação

TRA023

Contrafecho para FEC1093
Zamak Preto

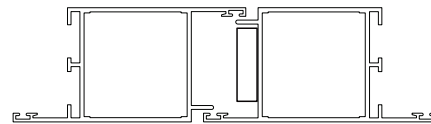
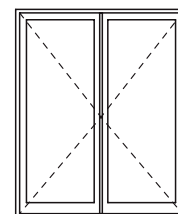
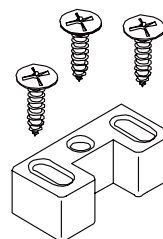

Aplicação

MAC1007

Maçaneta modelo Prima
Alumínio Pintado

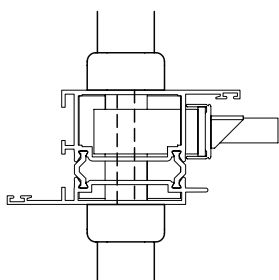
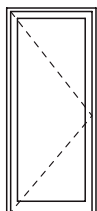
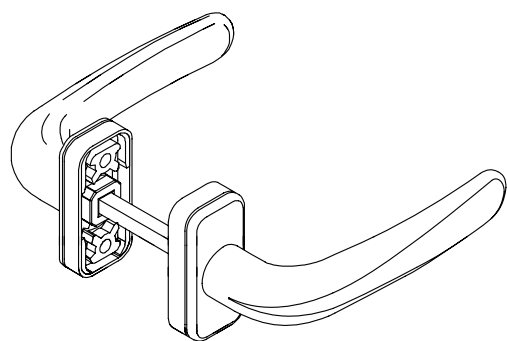

Aplicação

MAC1008

Maçaneta modelo Euro
Alumínio Pintado

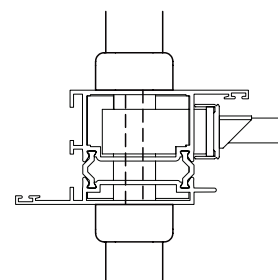
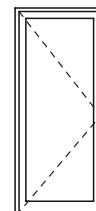
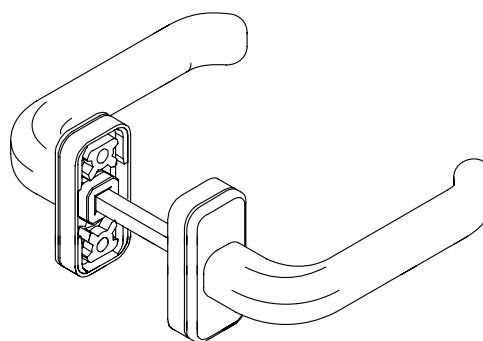

Aplicação

BUC779

Bucha Distanciadora para dobradiça com parafuso
Aço

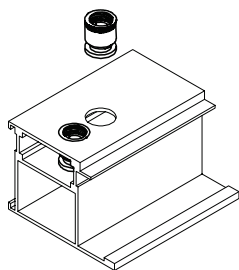
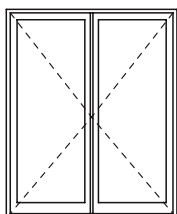
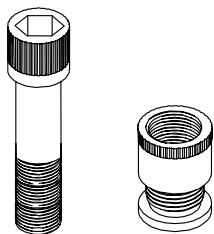

Aplicação

NOTA:
Usar somente porta 40TT,
abertura externa.

DOB858

Dobradiça com 3 abas
para porta de giro
Alumínio Branco ou Preto

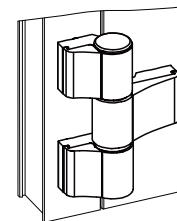
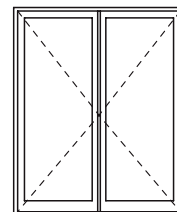
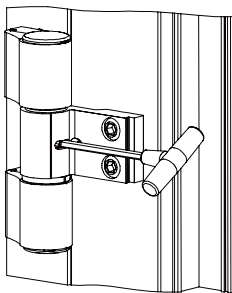
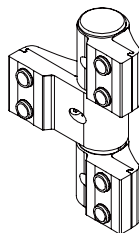
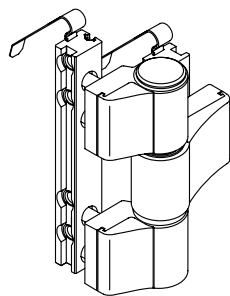

Aplicação

NOTA:
Aplicação em folhas com 2 dobradiças. Folha até 140kg.

DOB857

Dobradiça com 2 abas
para porta de giro
Alumínio Branco ou Preto

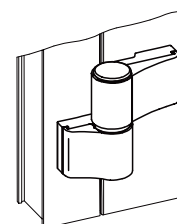
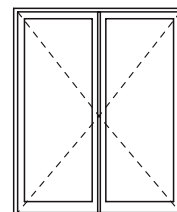
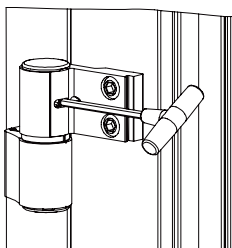
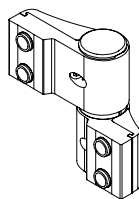
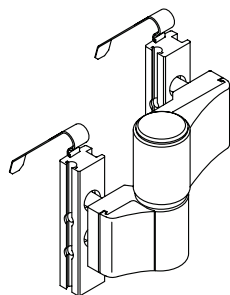

Aplicação

NOTA:
Aplicação em folhas com 2 dobradiças. Folha até 120kg.

GUA429

Guarnição do piso
EPDM Preto

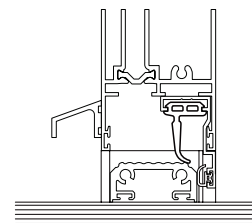
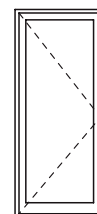
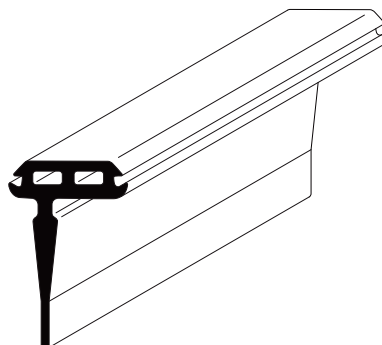

Aplicação

	Dimensão	Dimensões Máximas da Folha	Carga Máxima	Grau de Abertura
BRA800	414,5	L = 1400 H = 1200	88 kg	25°/30°
BRA801	707,5	L = 1400 H = 1700	120 kg	10°/15°/20°

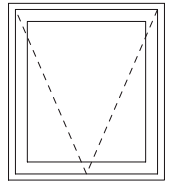

Braço Maxim ar

Aço Inox

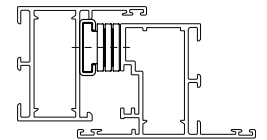
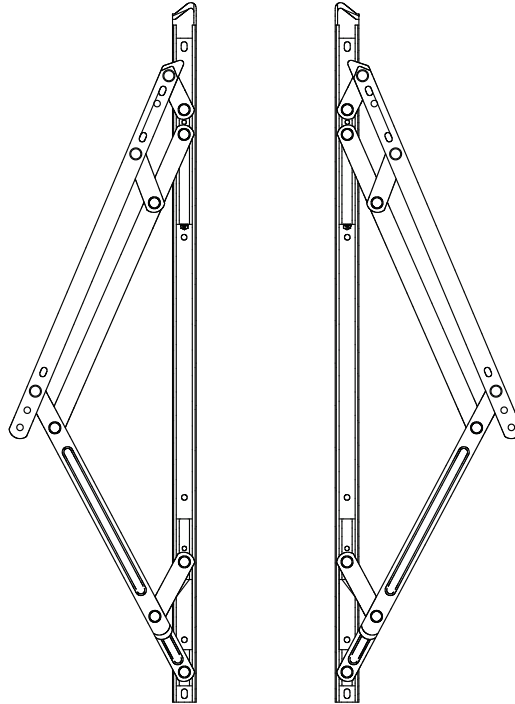

Aplicação

BRA761

Limitador de Abertura para Folhas c/ Altura Acima de 120mm Alumínio Fosco, Branco ou Preto

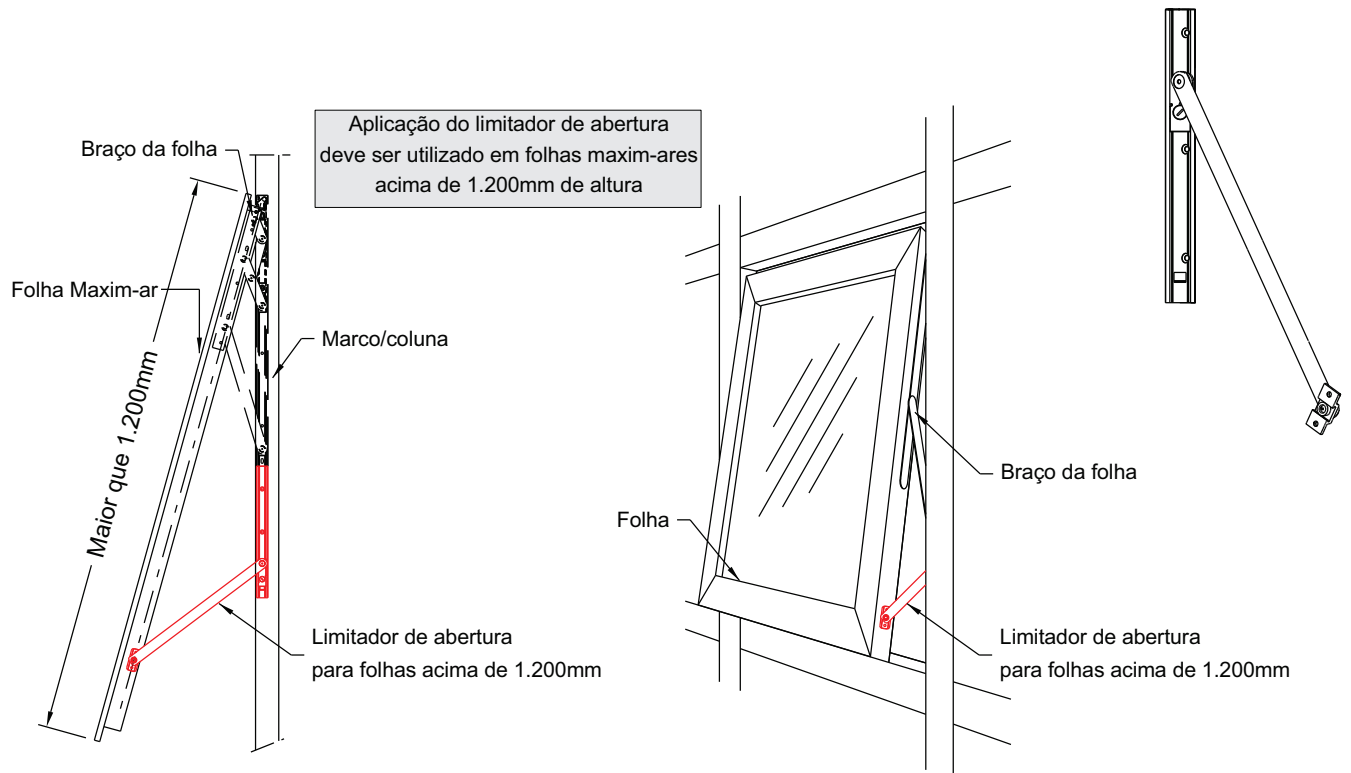

FEC1098

Fecho tipo cremona
Alumínio Preto ou Branco

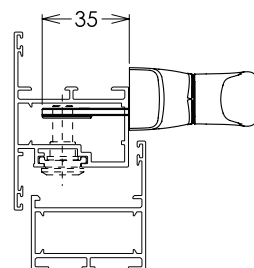
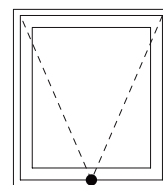
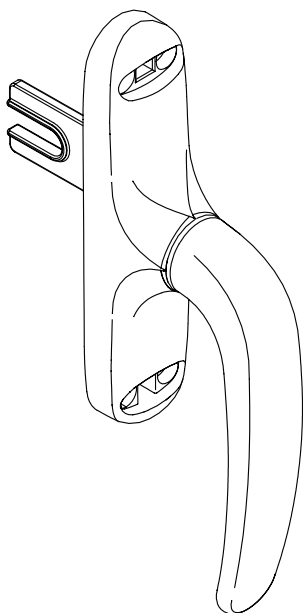

Aplicação

CON478

Trava complementar
Nylon Preto

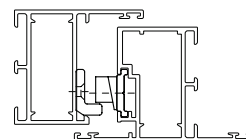
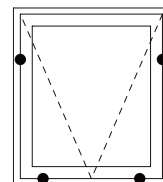
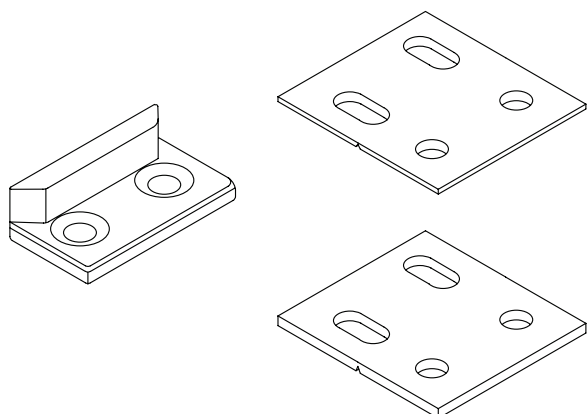

Aplicação

KIT625

Comando de travamento
Zamak

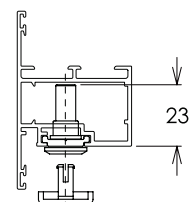
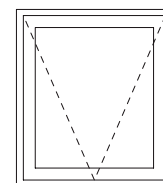
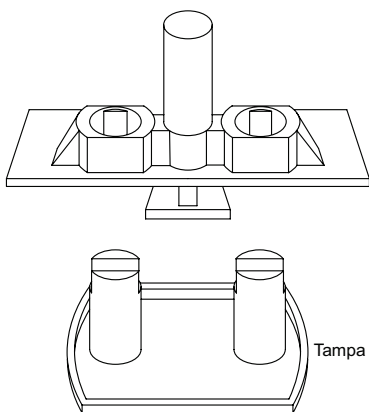

Aplicação

SUP688

Regulador da altura do braço
Zamak

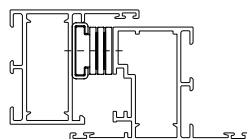
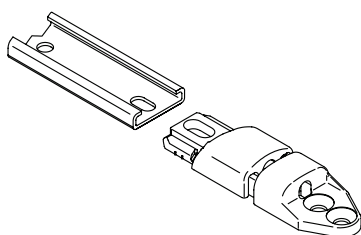
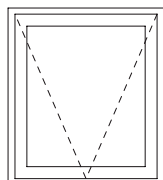

Aplicação

CON488

Conexão com parafuso 16,8mm x 36,1mm
Alumínio Natural

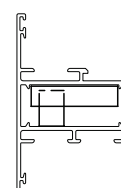
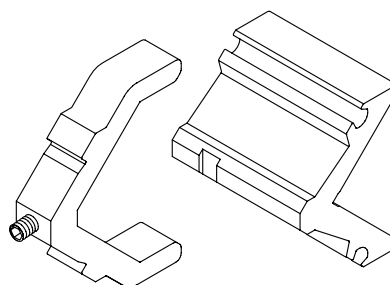
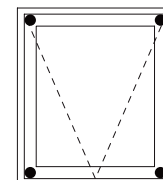

Aplicação

ROL486

Roldana dupla
com regulamento e rolamento
Nylon

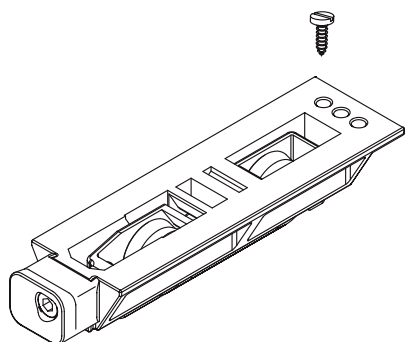
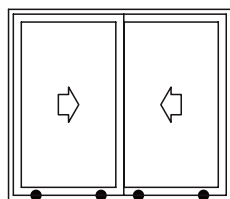

Carga máxima admissível = 80kg por folha

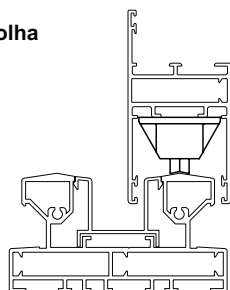

Aplicação

NYL446

Batedeira da folha
Nylon Branco ou Preto

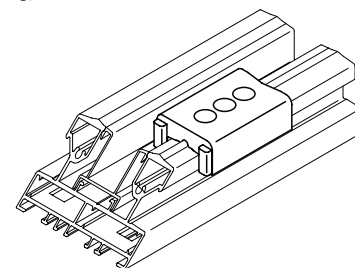
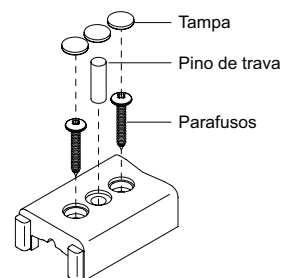
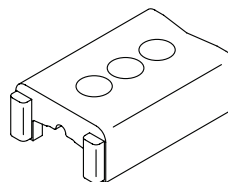
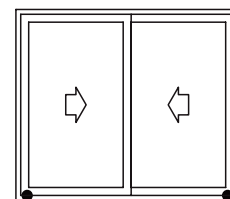

Aplicação

NYL482

Conexão de alinhamento
Nylon Preto

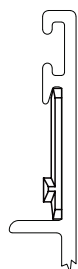
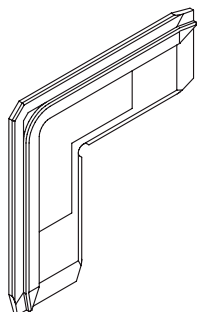
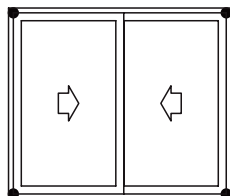

Aplicação

NYL489

Tampa lateral
Nylon Preto ou Branco

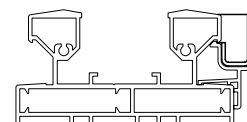
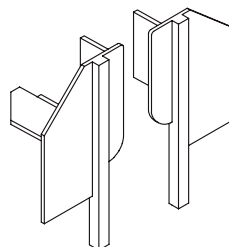
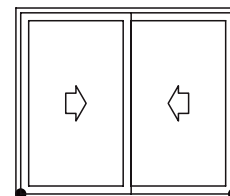

Aplicação

FEC1101

Fecho multiponto
Alumínio Branco ou Preto

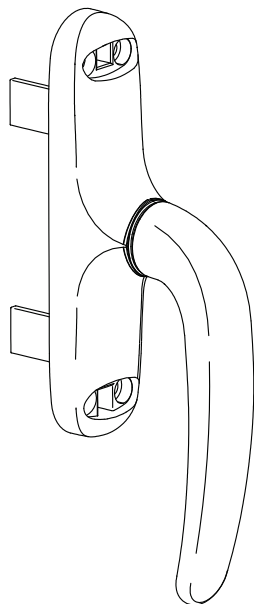
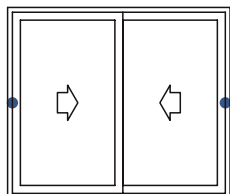
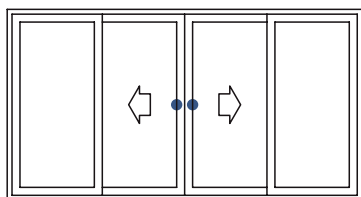

NOTA: Para cremona fixa, trava o acionamento eliminando as hastes.

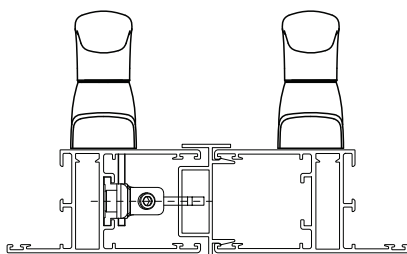

Aplicação

TRA019

Lingueta do fecho multiponto
Aço Inox

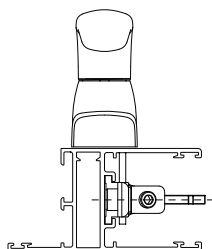
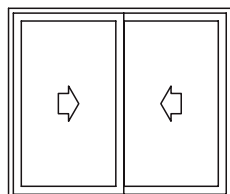
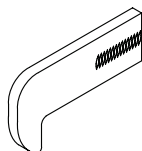

Aplicação

CON479

Contrafecho do multiponto
Zamak Natural

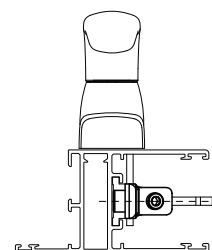
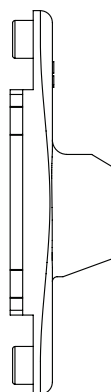
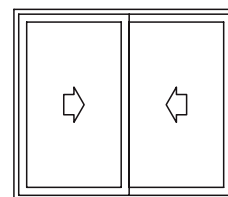

Aplicação

KITGN25

Kit de travamento
Nylon Preto

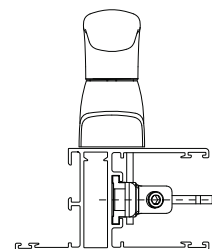
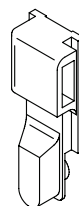
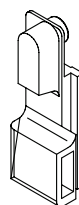
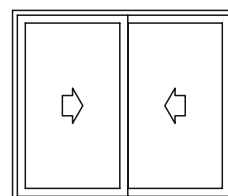

Aplicação

FEC1106

Fecho concha
com multiponto
Alumínio Branco ou Preto

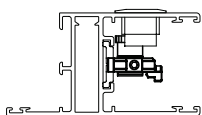
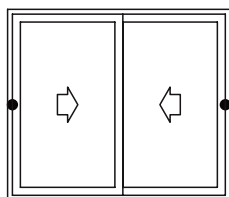
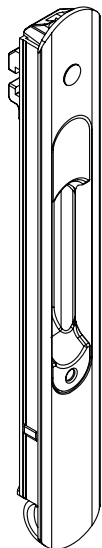

Aplicação

FEC464

Conjunto de trava
do fecho
Zamak e Aço Inox

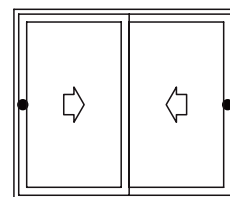
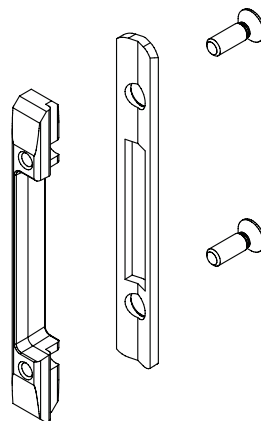

TRA022

Trava do fecho concha
Zamak Natural

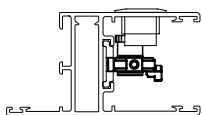
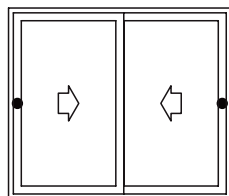
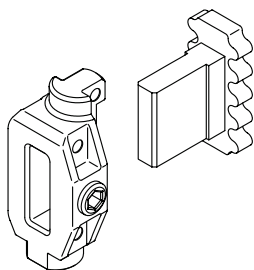

Aplicação

CON480

Calço de segurança
da folha
Alumínio Branco ou Preto

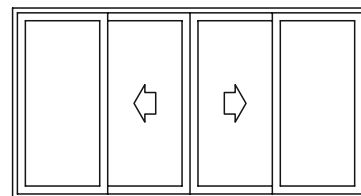
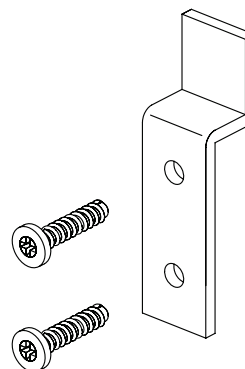

KIT627

Kit de tampas central
Nylon

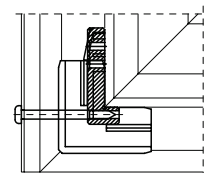
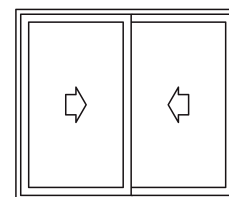
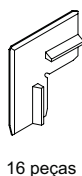
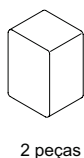
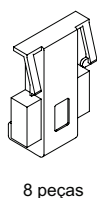
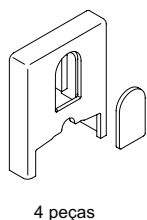
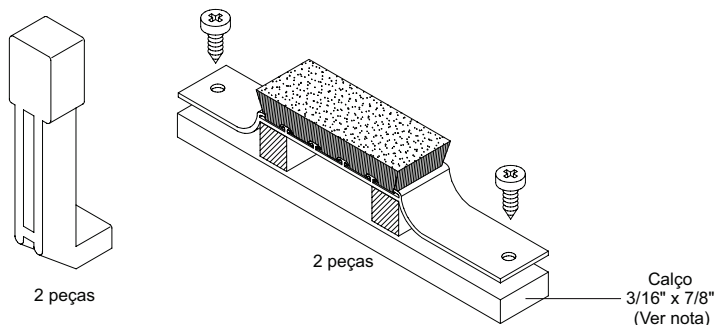

Aplicação

NOTA:
Calço usado somente na parte superior, para portas com perfis RO054 e RO057.

NYL550

Tampa de Acabamento
Saída da Água
Branco ou Preto

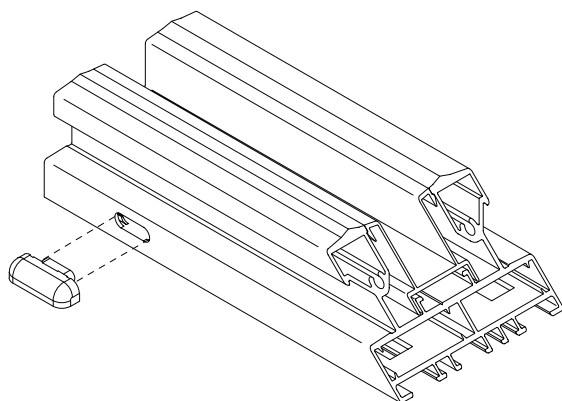
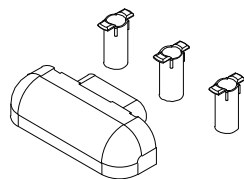
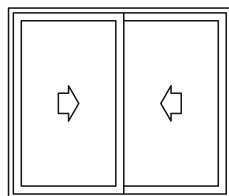

Aplicação

FIT260

Fita vedadora com barreira plástica
6,5 x 6,5 mm
Preta

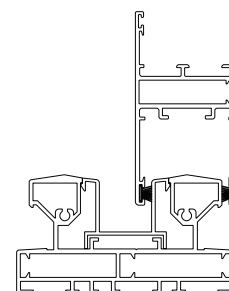
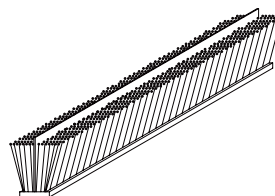
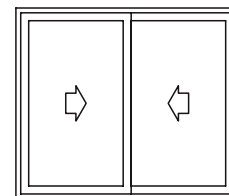

Aplicação

CON481

Conexão com parafuso 9,8mm x 36,1mm
Alumínio Natural

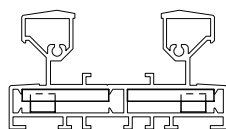
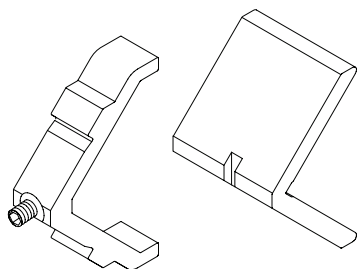
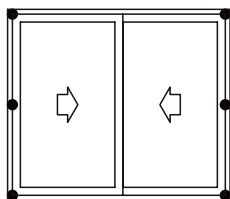

Aplicação

CON486

Conexão com parafuso 9,8mm x 36,1mm
Alumínio Natural

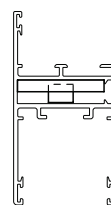
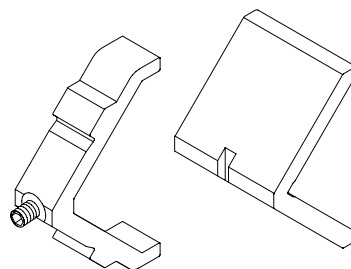
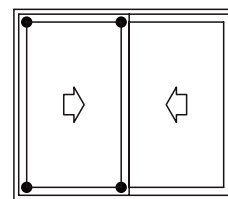

Aplicação

CON482

Conexão com parafuso 9,8mm x 20,3mm
Alumínio Natural

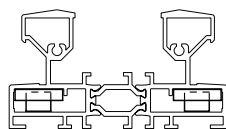
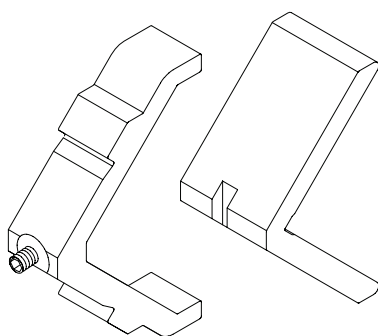
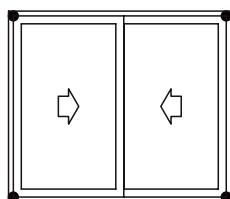

Aplicação

CON487

Conexão com parafuso 9,8mm x 20,3mm
Alumínio Natural

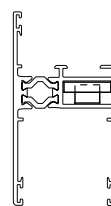
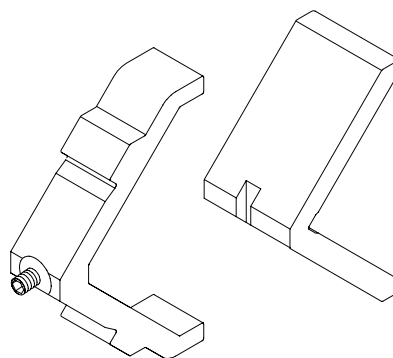
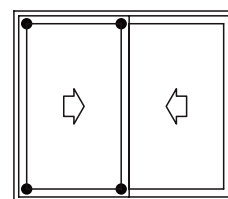

Aplicação

ROL010

Roldana dupla
com regulamento e rolamento
Aço Inox e Nylon

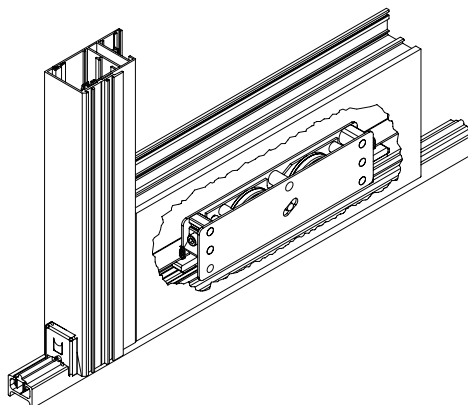
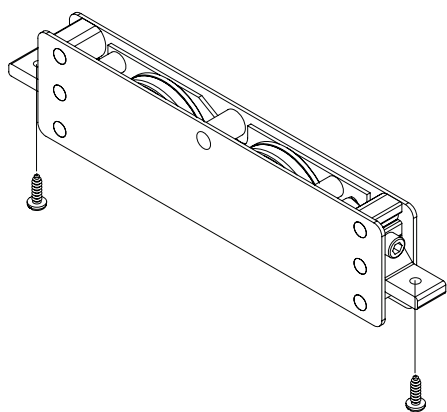
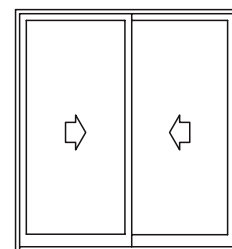

Carga máxima admissível = 240kg por folha

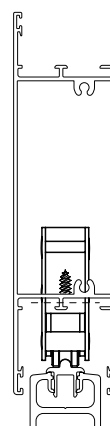

Aplicação

FRA823

Fechadura bico de papagaio
Latão Branco, Preto, Cromado

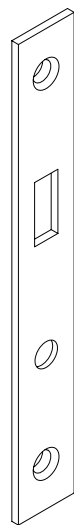
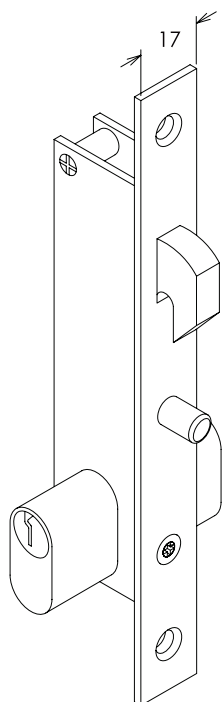
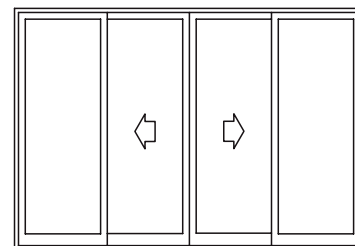

Espelho

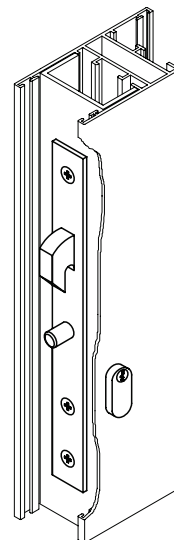
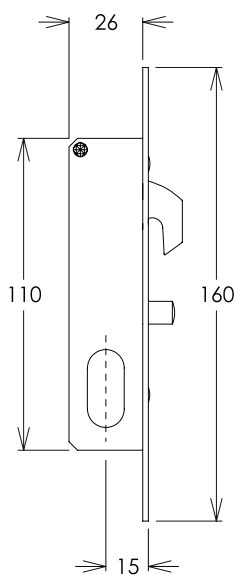

Aplicação

NYL500

Tampa do puxador RO100
Nylon Preto ou Branco

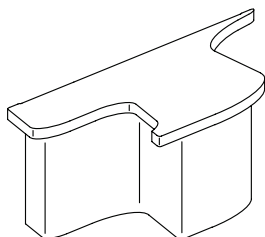
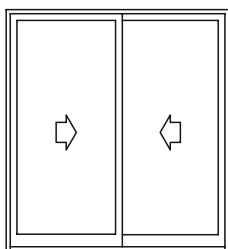

Aplicação

NYL501

Tampa do puxador RO101
Nylon Preto ou Branco

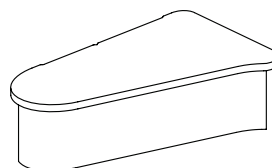
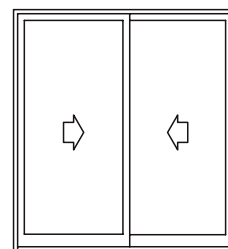

Aplicação

NYL502

Tampa do puxador RO102
Nylon Preto ou Branco

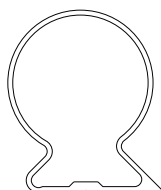
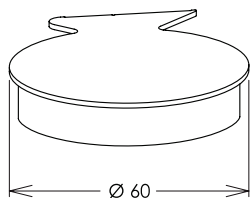
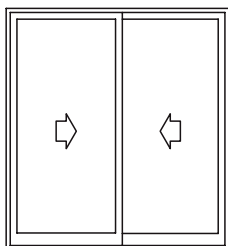

Aplicação

NYL503

Tampa do puxador RO103
Nylon Preto ou Branco

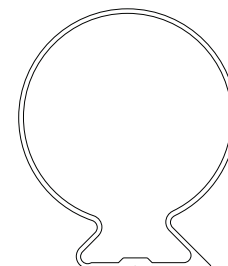
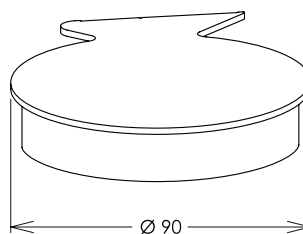
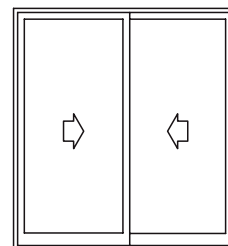

Aplicação

CAL944

Calço de vedação da folha
Alumínio Natural

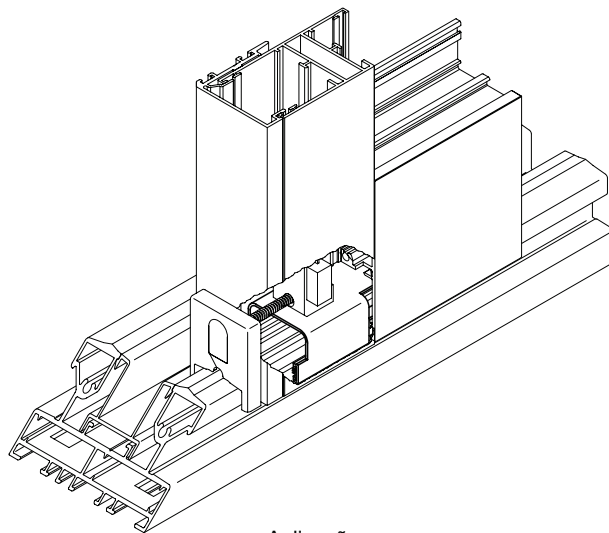
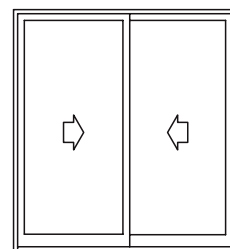
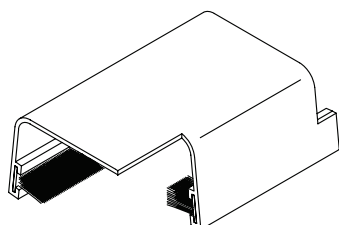

Aplicação

CON427

Contratesta da fechadura
Aço Inox

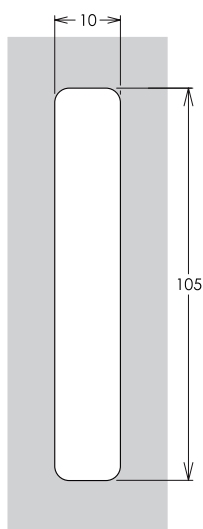
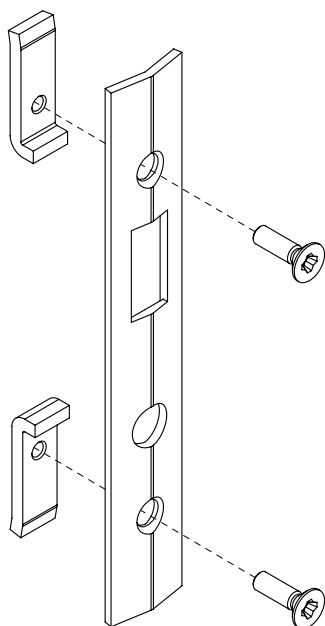

Detalhe de Usinagem

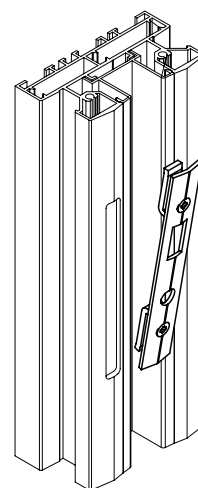
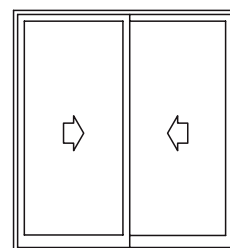

Aplicação

PUX200

Puxador
Alumínio Branco ou Preto

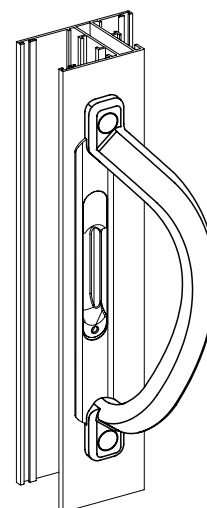
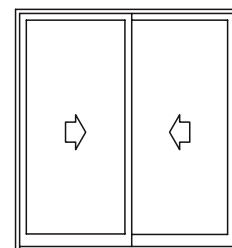
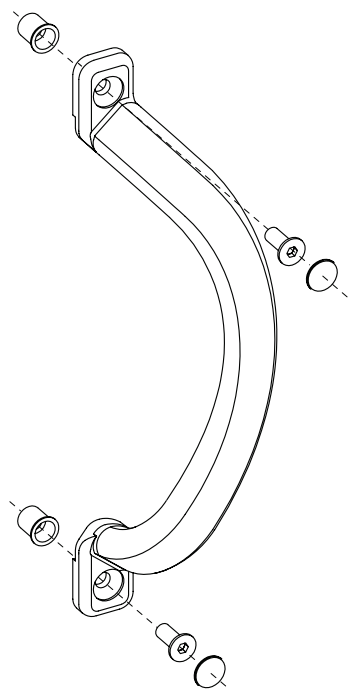

Aplicação

NYL506

Tampa para os perfis Ro180 e RO225
Nylon Branco ou Preto

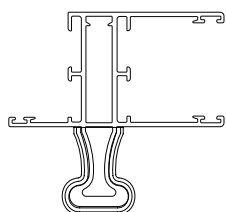
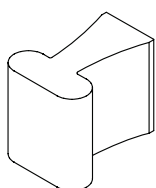
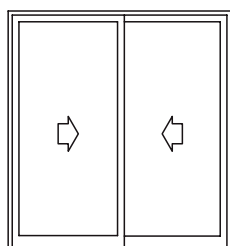

Aplicação

KIT648

Kit vedação superior
Nylon

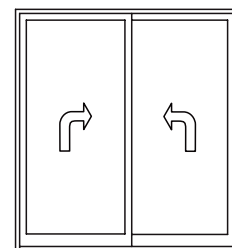
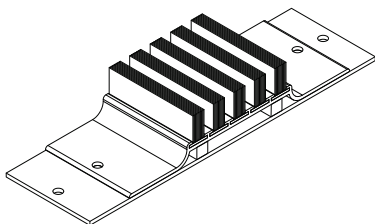

KIT650

Conjunto do rodízio
Aço

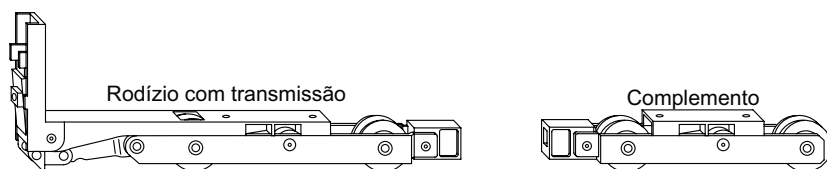

Capacidade máxima = 300 kg
Largura máxima da folha = 2500 mm

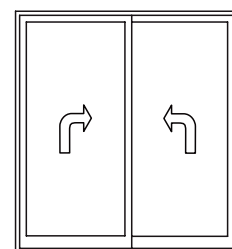

KIT651

Rodízio auxiliar
Aço

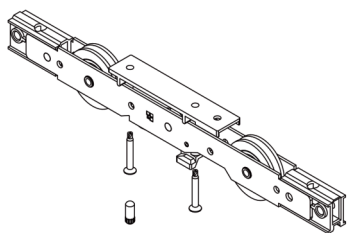

Para folha com largura acima de 2500 mm

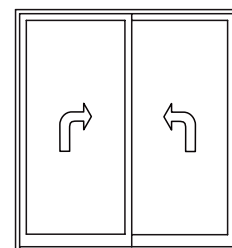

TRA057

Trava multiponto
Zamak

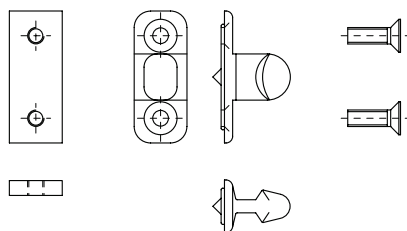
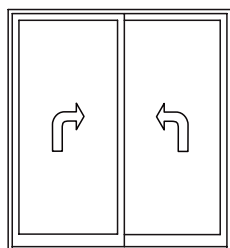

BAT949

Batedeira da folha
Alumínio Preto

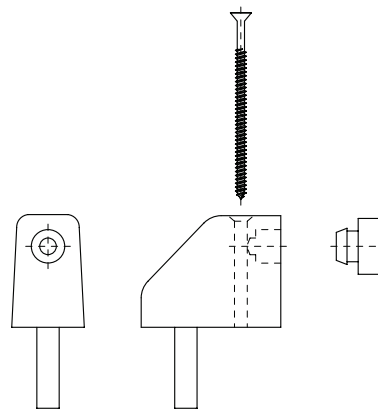
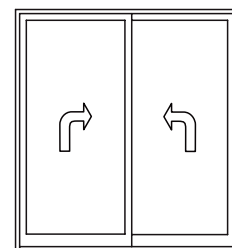

MAC1039

Maçaneta sem chave
Alumínio

MAC1040

Maçaneta com chave
Alumínio

MAC1040

Maçaneta interna e externa com chave
Alumínio

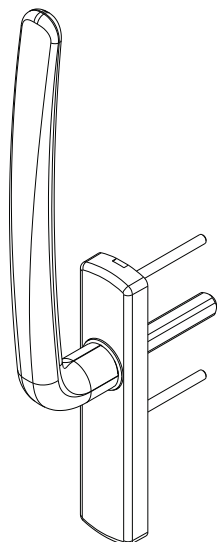
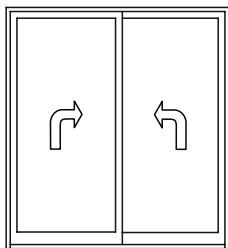

SUP989

Suporte e guia da folha
Nylon Preto

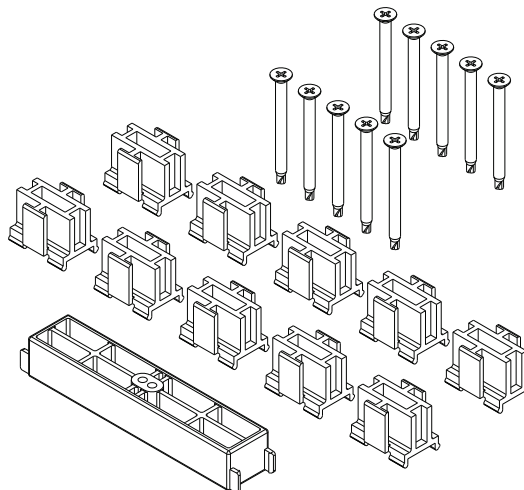
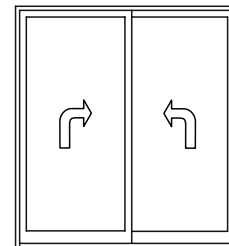

CON494

Puxador da folha
Alumínio

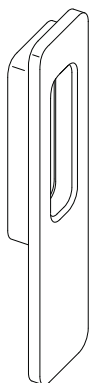
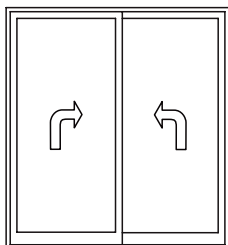

Prafusos
de fixação

NYL505

Limitador e guia da folha
Nylon Preto e branco

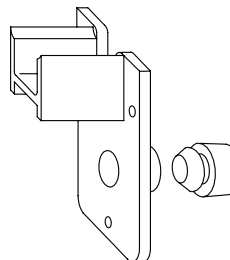
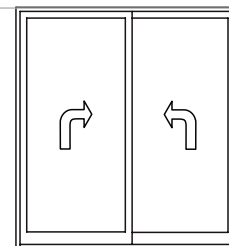

CIL011

Cilindro inteiro para MAC1041

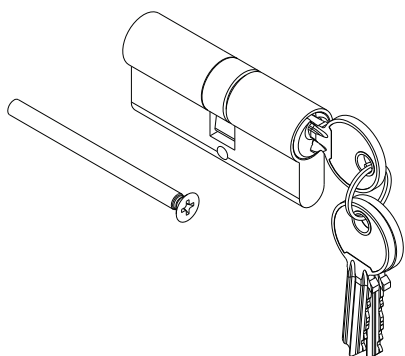

CIL012

Maeio cilindro para MAC1040

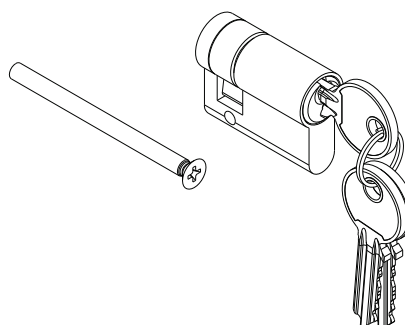

KIT652

Barra de comando de 2000 mm

KIT653

Barra de comando de 2300 mm

KIT654

Barra de comando de 2600 mm

KIT655

Barra de comando de 3000 mm

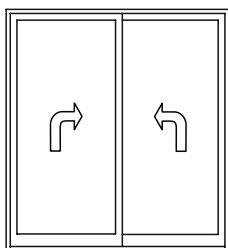

TRA054

Barra de travamento entre roldanas
Com 900 mm - 600 < L < 1500

TRA055

Barra de travamento entre roldanas
Com 1400 mm - 1501 < L < 2000

TRA056

Barra de travamento entre roldanas
Com 1400 mm - 2001 < L < 2500

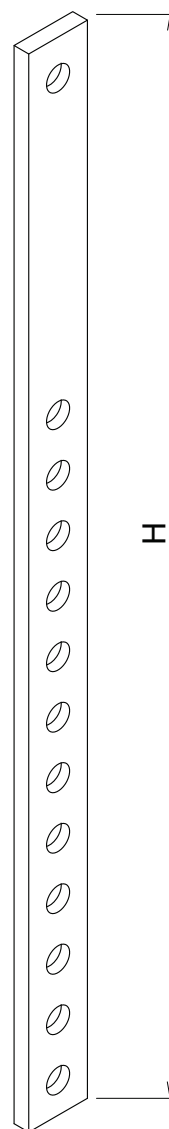
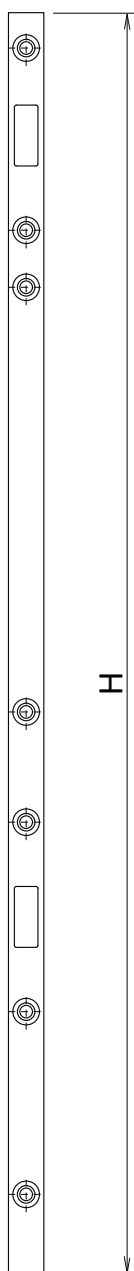
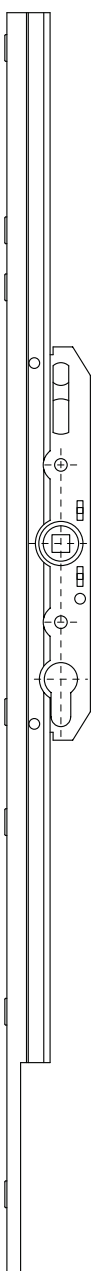
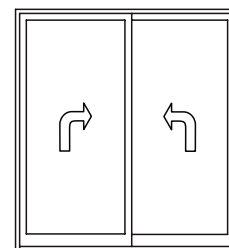

FIT222

Fita vedadora com barreira 7mm x 8mm
Preta

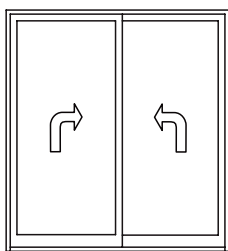

FIT211

Fita vedadora com barreira 5mm x 8mm
Preta

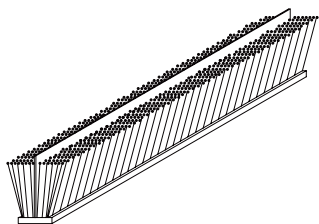

CON422

Conexão de alinhamento
60,2mm x 3mm
Alumínio Natural

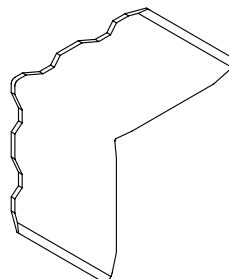
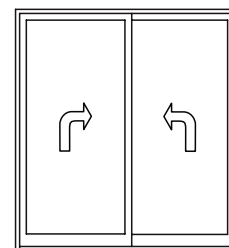

NYL538

Guia de nylon
Preto

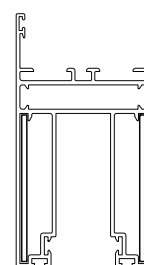
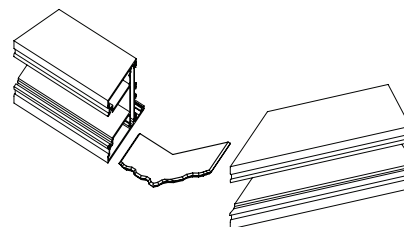

Aplicação

CAL976

Calço guia de Nylon
Preto

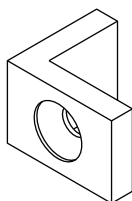

GUA337

Guarnição da matajunta
EPDM Preto

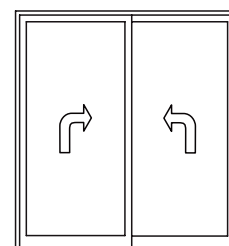

PAR1014

Parafuso A/A cabeça chata fenda philips 4,2 x 16 mm
Aço inox

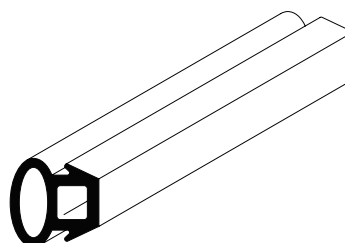
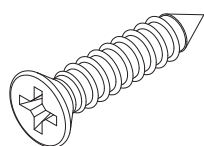

Aplicação

CON492

Conexão com parafuso 9,8mm x 44,1mm
Alumínio Natural

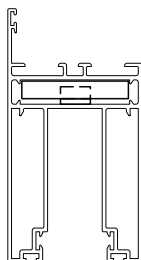
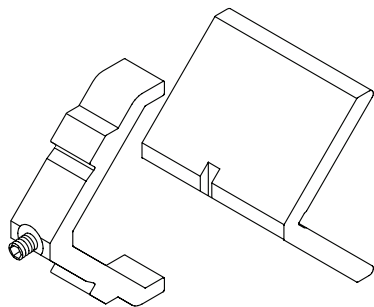
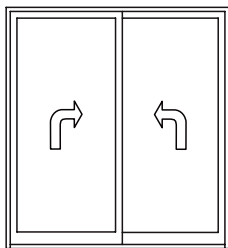

Aplicação

GUA338

Guação inferior
EPDM Preto

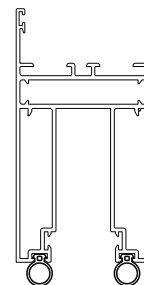
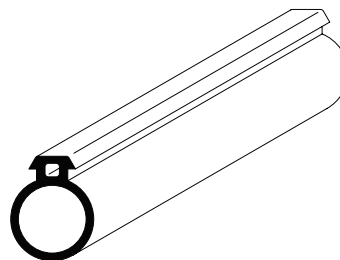
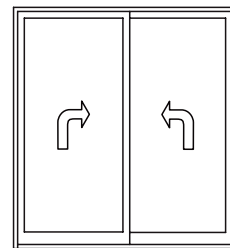

Aplicação

NYL382

Fechamento lateral da tampa MN031
ABS Branco ou Preto

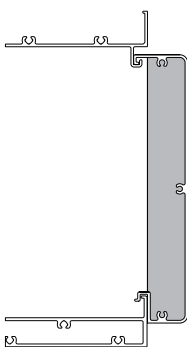
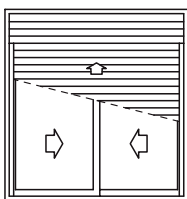
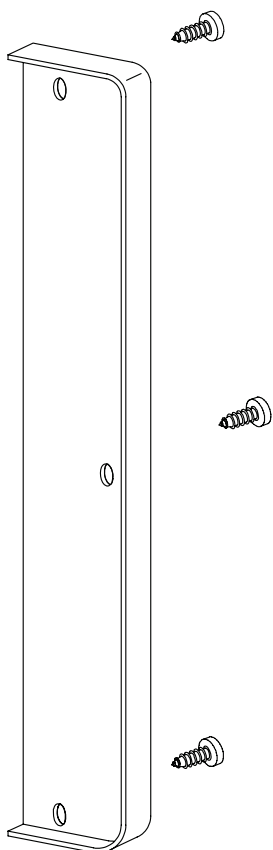

Aplicação

NYL481

Fechamento lateral da tampa LG167
ABS Branco ou Preto

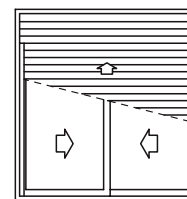
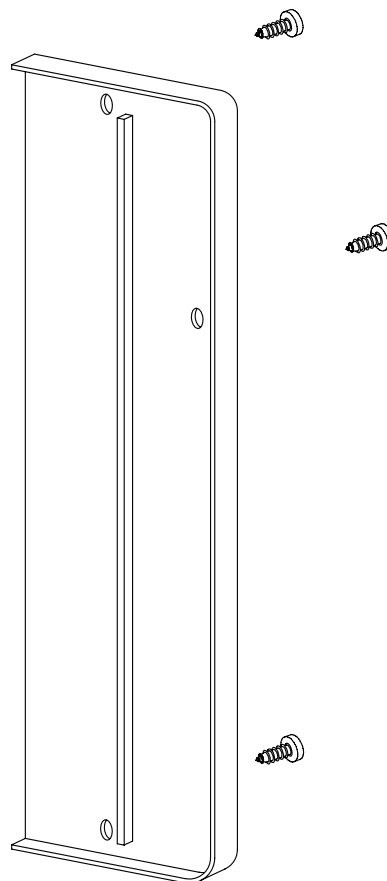

Aplicação

NYL042

Botão Tampa furo 3/8"
Nylon Preto ou Branco

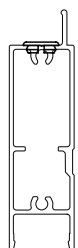
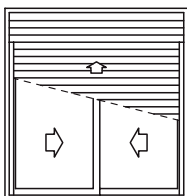

Aplicação

NYL370

Guia da Persiana
Nylon Preto

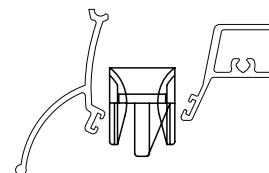
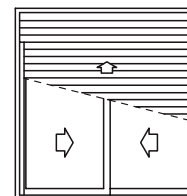
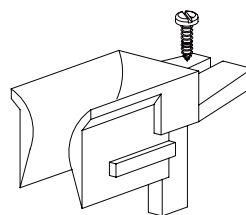

Aplicação

FIT214

Fita Vedadora 5 x 10 mm
Preta

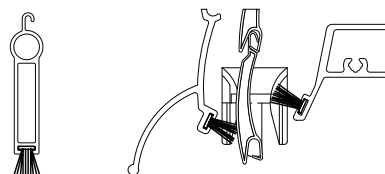
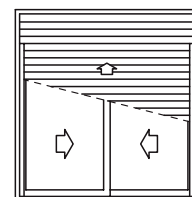
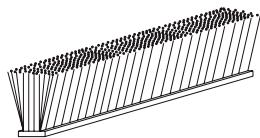

Aplicações

FIT206

Fita Vedadora 5 x 6 mm
Preta

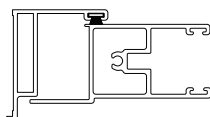
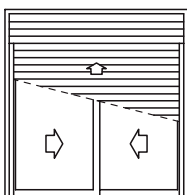
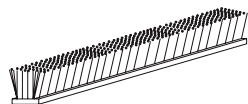

Aplicação

GUA209

Guarnição interna
EPDM Preto

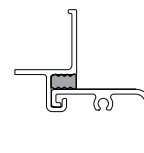
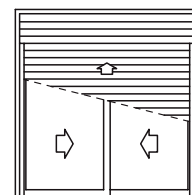
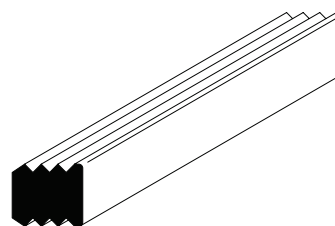

Aplicação

GUA289

Guarnição externa
EPDM Preto

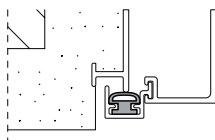
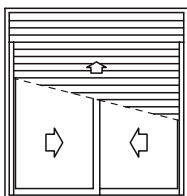
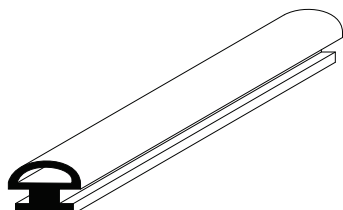

Aplicação

GUA005

Guarnição externa
EPDM Preto

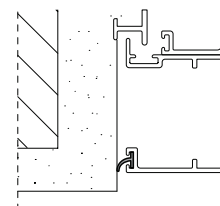
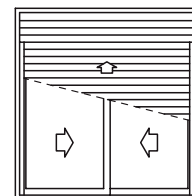
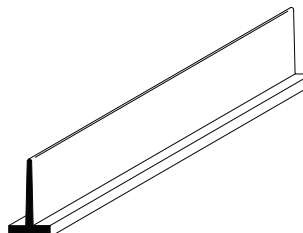

Aplicação

NYL435

Fecho de acionamento giratório
Nylon Preto

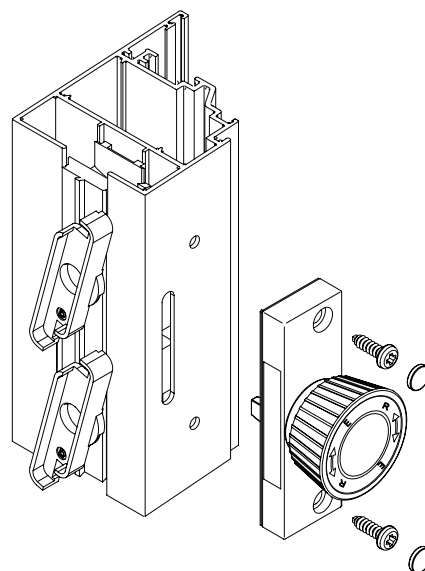
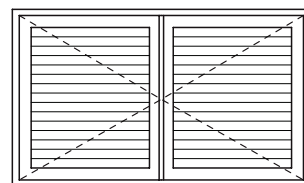
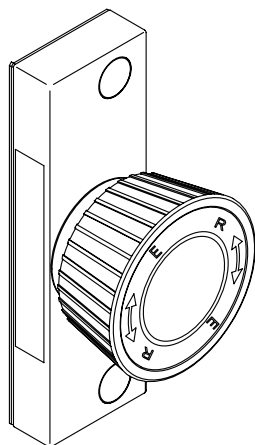

Aplicação

Sob consulta

FEC1108

Fecho tipo cremone
Alumínio Preto ou Branco

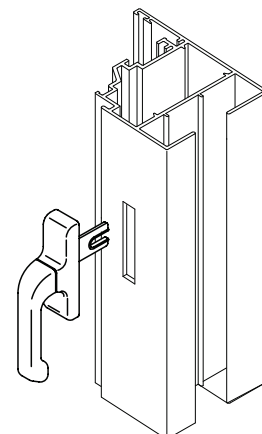
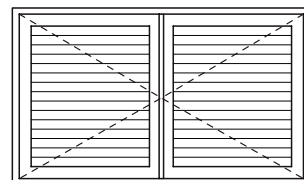
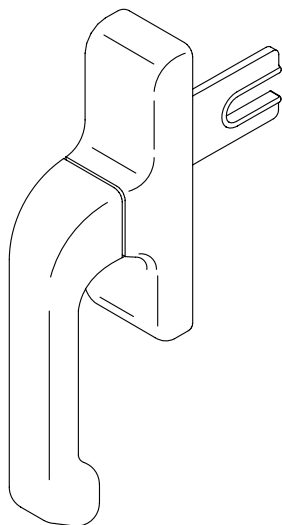

Aplicação

Sob consulta

NYL434

Conjunto de comando da veneziana
Nylon Preto

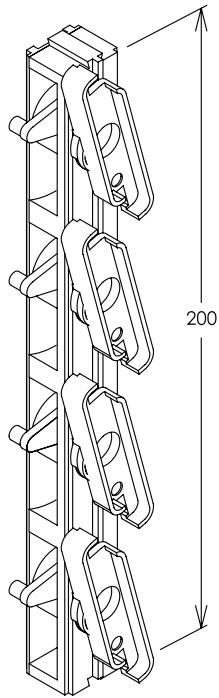
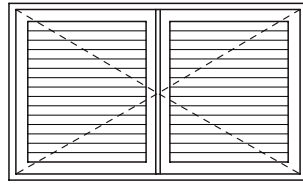

Esquerdo

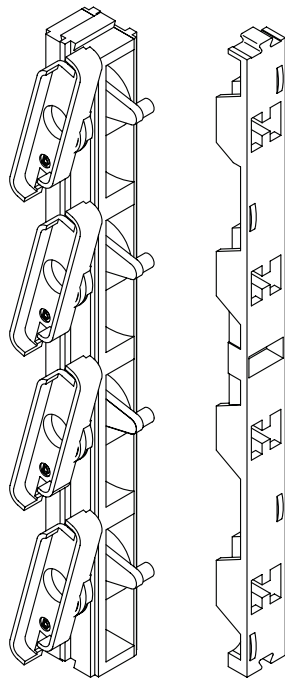

Direito

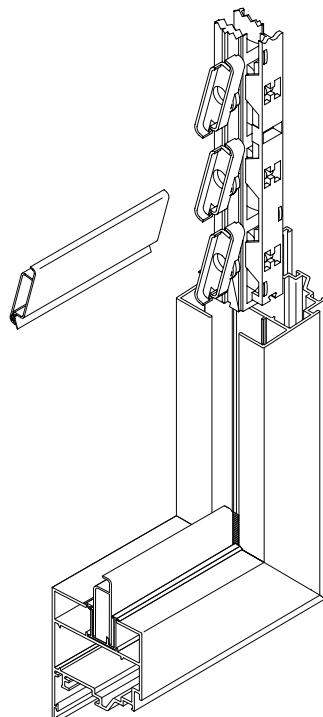

Aplicação

Sob consulta

NYL438

Calço inferior
Nylon Preto

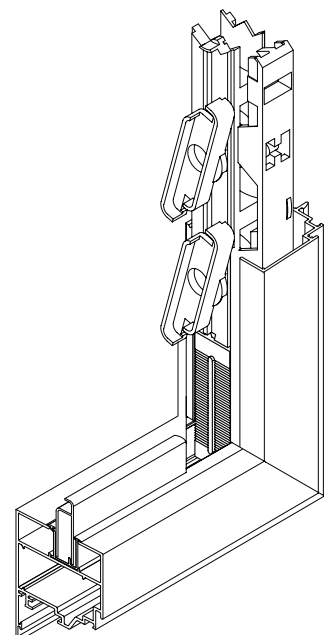
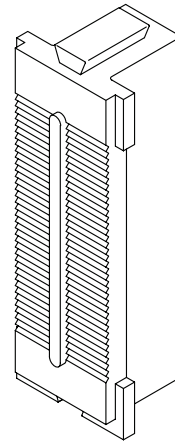
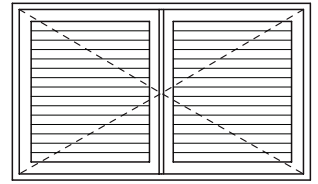

Aplicação

Sob consulta

NYL436

Fecho de acionamento - Direito
Nylon Preto

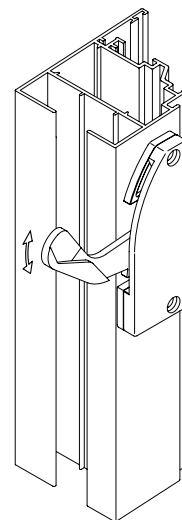
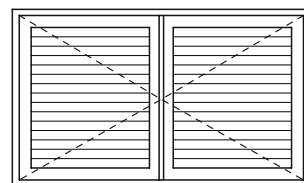
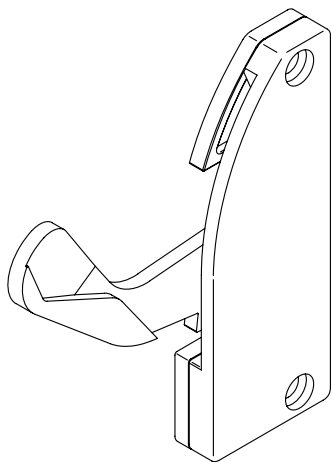

Aplicação

Sob consulta

NYL437

Fecho de acionamento - Esquerdo
Nylon Preto

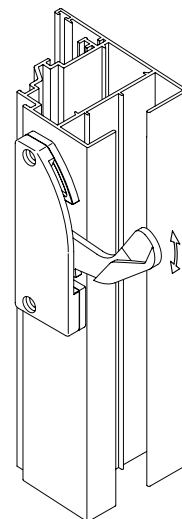
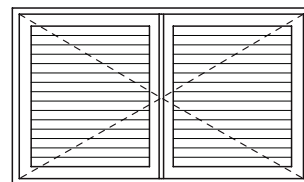
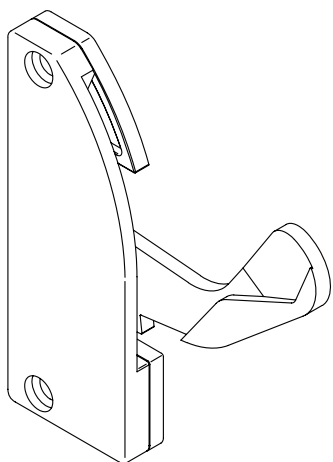

Aplicação

Sob consulta

DOB848

Dobradiça de 2 abas
Branco e preto

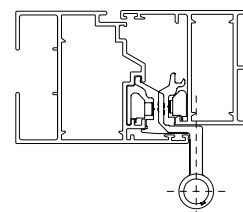
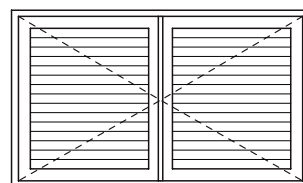
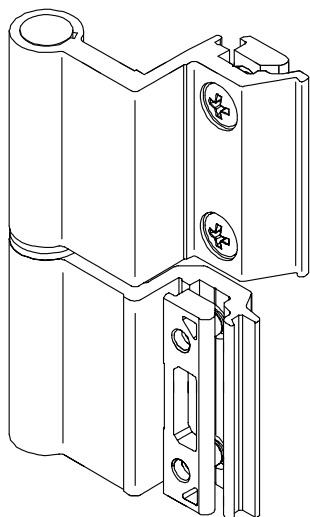

Aplicação

Sob consulta

GUA360

Guarnição da veneziana
EPDM

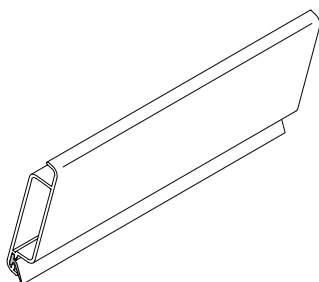
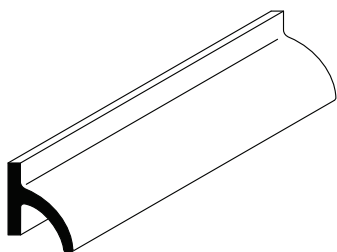
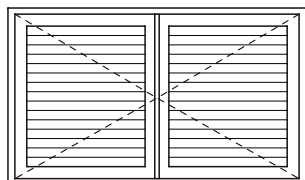

Aplicação

Sob consulta

CON470

Conexão com parafuso
24,8mm x 36,1mm
Alumínio Natural

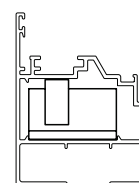
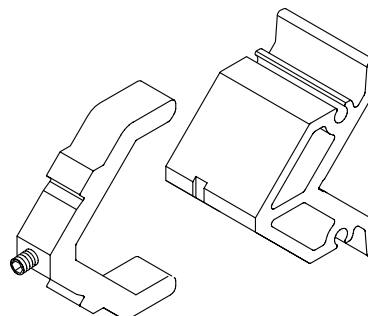
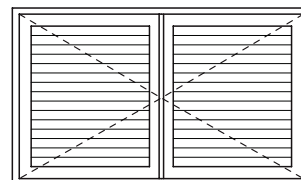

Aplicação

Descrição	Pág.
EST682 ESTAMPO PNEUMÁTICO	H-01

EST682

Estampo Pneumático



Descrição	Pág.
USINAGEM PARA CREMONA - OSCILO BATENTE E DOBRÁVEL	I-01
FOLHA DA PORTA OSCILO PARALELA	I-02
SAÍDA DE ÁGUA	I-03
MÃO-DE-AMIGO	I-04
USINAGEM PARA ENTRADA DA BARRA DE COMANDO, COMPONENTES E CONEXÃO	I-05
BARRA DE COMANDO	I-05
USINAGEM PARA ALOJAMENTO DA CONEXÃO	I-05
USINAGENS PARA CREMONA E FECHO CONCHA	I-06
USINAGENS PARA FIXAÇÃO DA TRAVESSA - PORTA	I-07
USINAGEM DA TAMPA SUPERIOR DO MONTANTE - PORTA	I-08
USINAGEM DA TAMPA INFERIOR DO MONTANTE - PORTA	I-09
USINAGEM DA TAMPA SUPERIOR DO MONTANTE - JANELA	I-10
USINAGEM DA TAMPA INFERIOR DO MONTANTE - JANELA	I-11
SAÍDA DE ÁGUA - JANELA DE CORRER 2 FOLHAS	I-12
SAÍDA DE ÁGUA - JANELA DE CORRER 3 FOLHAS	I-13
SAÍDA DE ÁGUA - JANELA DE CORRER 4 FOLHAS	I-14
SAÍDA DE ÁGUA - PORTA DE CORRER 2 FOLHAS	I-15
SAÍDA DE ÁGUA - PORTA DE CORRER 4 FOLHAS	I-16
USINAGENS PARA FECHO MULTIPONTO - JANELA MAXIM-AR	I-17
USINAGEM PARA CONTRAFECHO - CREMONA E CONCHA - PORTA	I-18
USINAGEM PARA CONTRAFECHO - CREMONA E CONCHA - JANELA	I-19
USINAGEM PARA FECHADURA - PORTA DE GIRO	I-20
USINAGENS PARA DOBRADIÇAS 2 E 3 ABAS - PORTA DE GIRO	I-21
USINAGEM DA TRAVESSA E ROLDANA	I-22
MÃO-DE-AMIGO - PORTA ELEVÁVEL	I-23
USINAGENS PARA CREMONA INTERNA - PORTA ELEVÁVEL	I-24
USINAGENS PARA CONCHA EXTERNA - PORTA ELEVÁVEL	I-25
USINAGENS PARA FECHADURA - PORTA ELEVÁVEL	I-26
USINAGEM DE TOPO - TRAVESSAS	I-27 a I-29

USINAGEM PARA CREMONA - OSCILO BATENTE E DOBRÁVELUsinar
Perfis

RO010

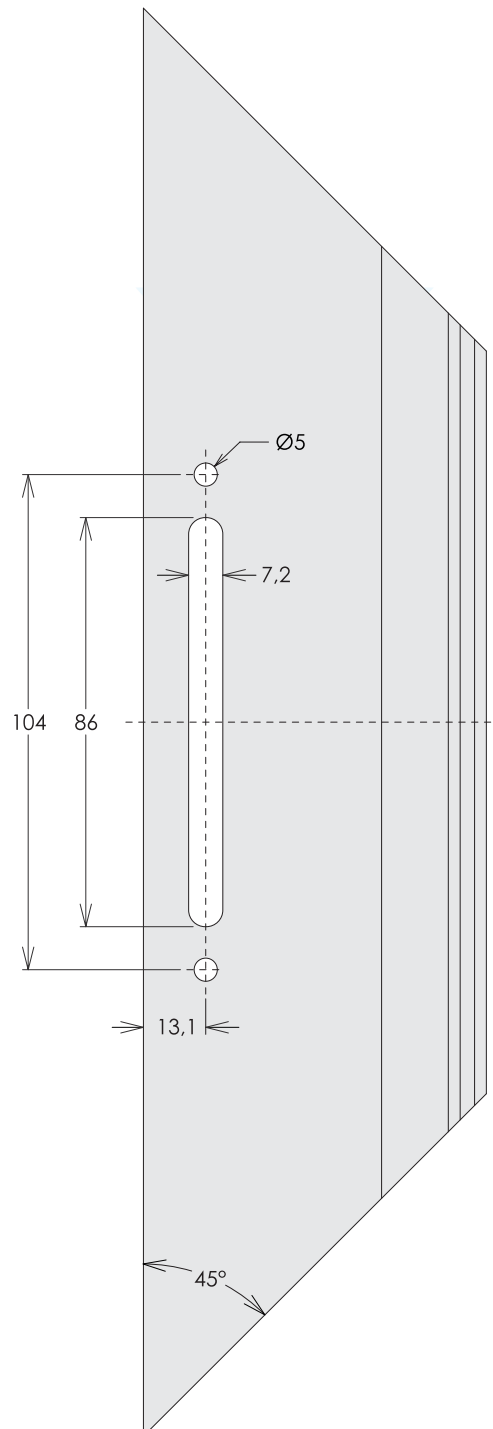
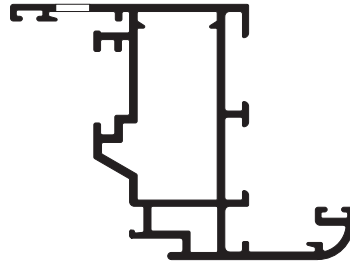

FOLHA DA PORTA OSCILO PARALELA

Usinar
Perfis
RO010

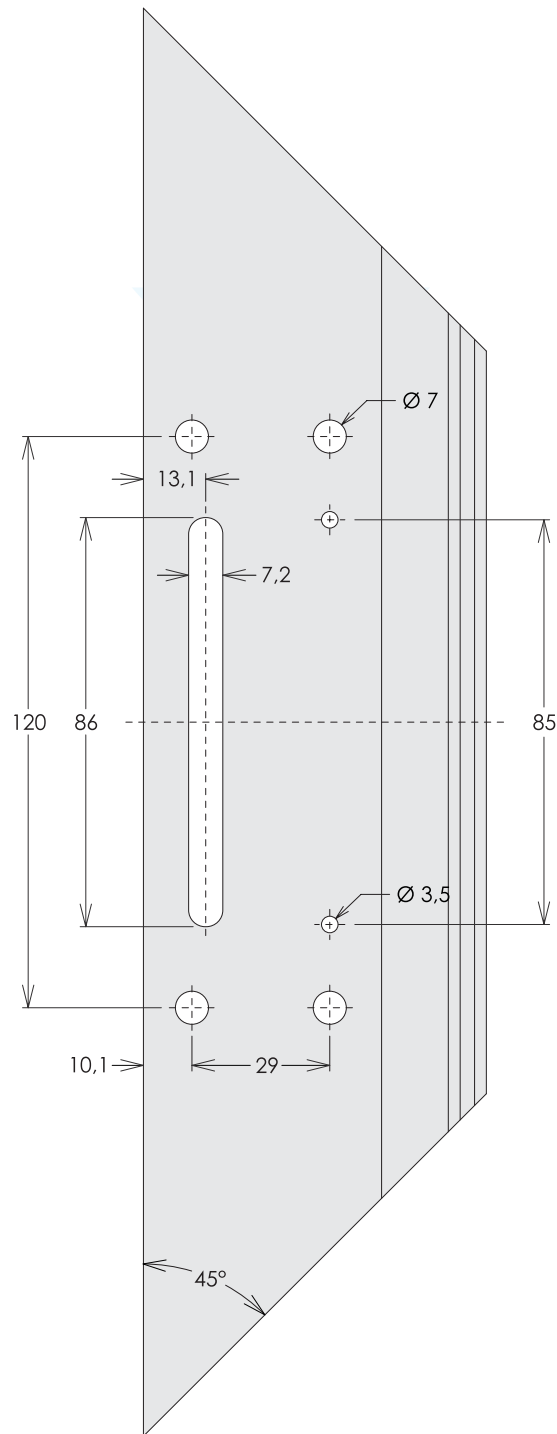
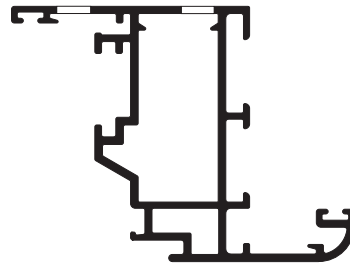

SAÍDA DE ÁGUA

Usinar
Perfis
RO008

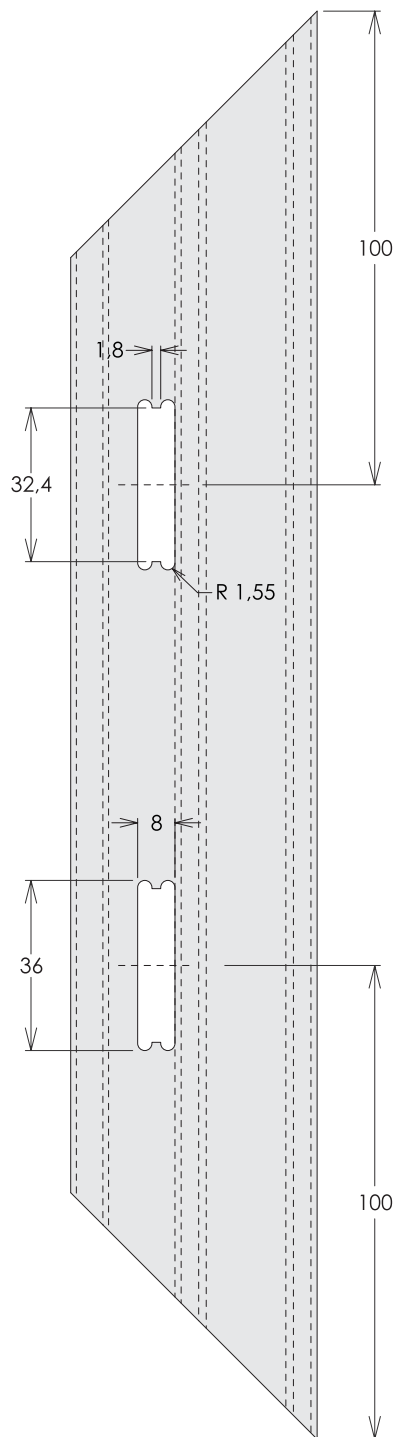
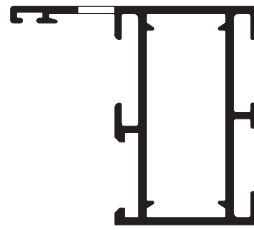

MÃO-DE-AMIGO

Usinar
Perfis
RO064

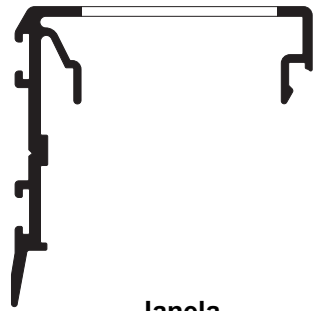

Janela

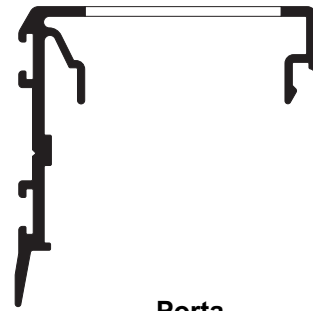
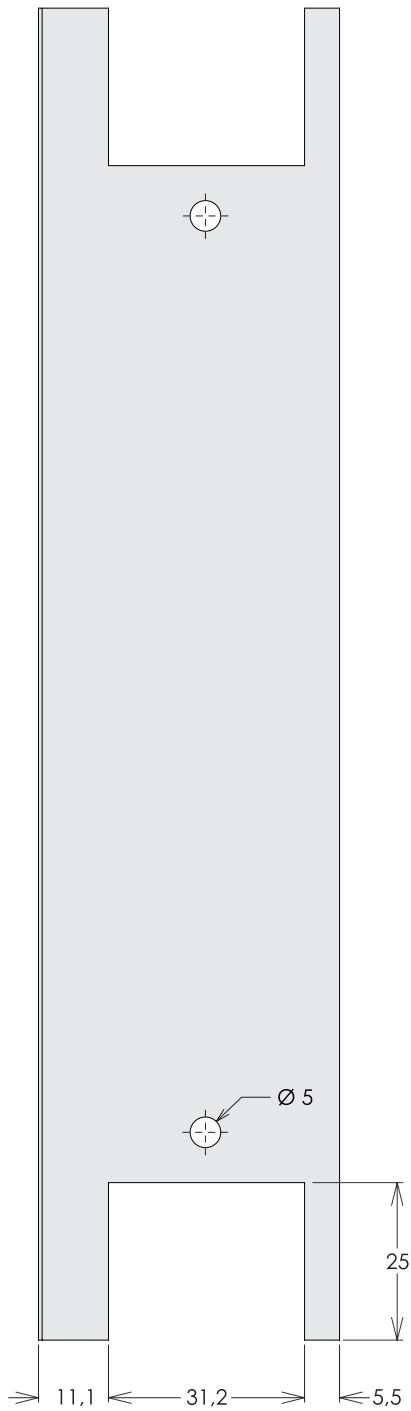

Porta

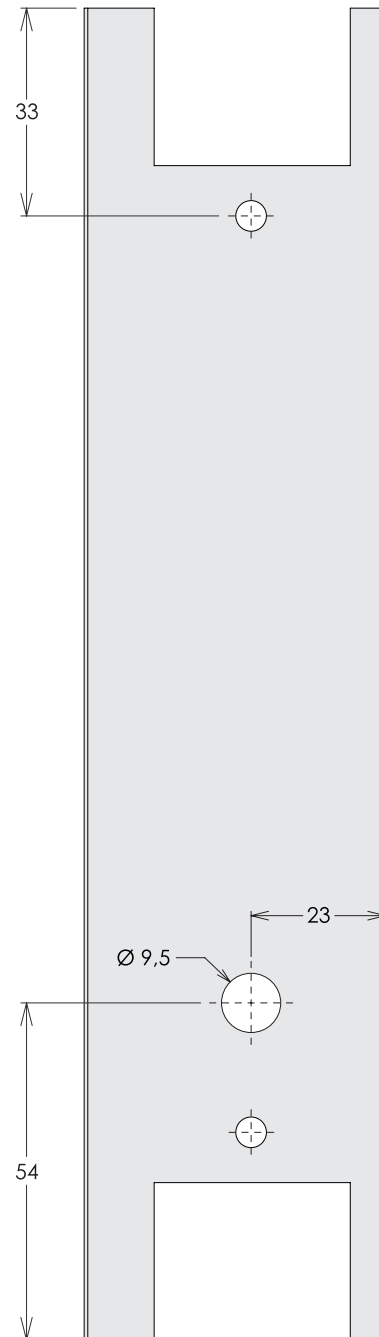

USINAGEM PARA ENTRADA DA BARRA DE COMANDO, COMPONENTES E CONEXÃO

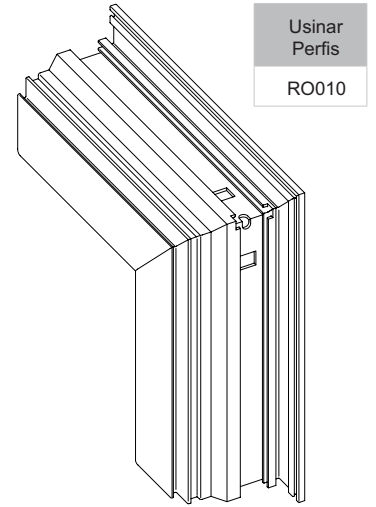
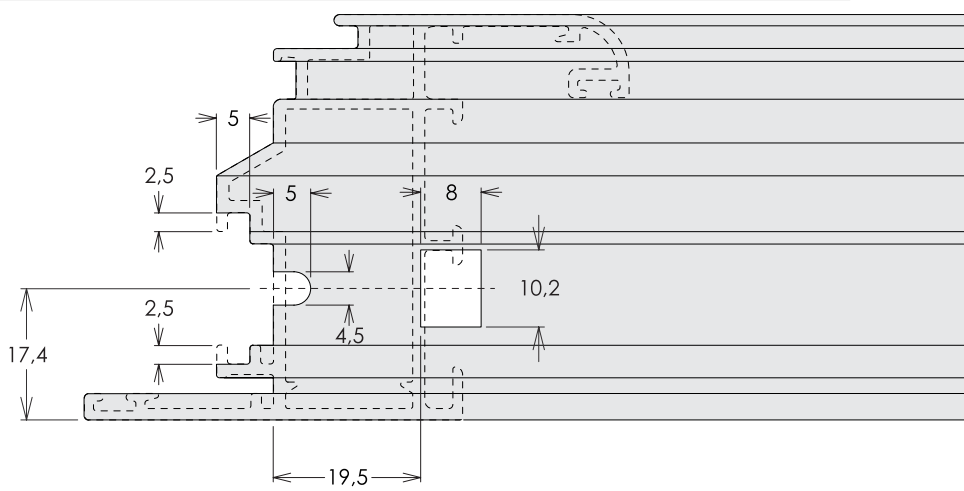

Usinar Perfis
RO010

BARRA DE COMANDO

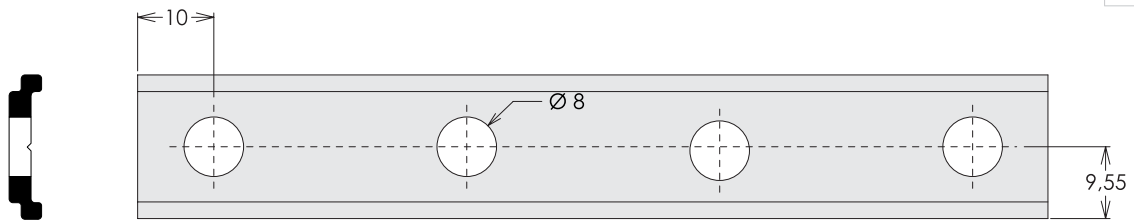

Usinar Perfis
RO016

USINAGEM PARA ALOJAMENTO DA CONEXÃO

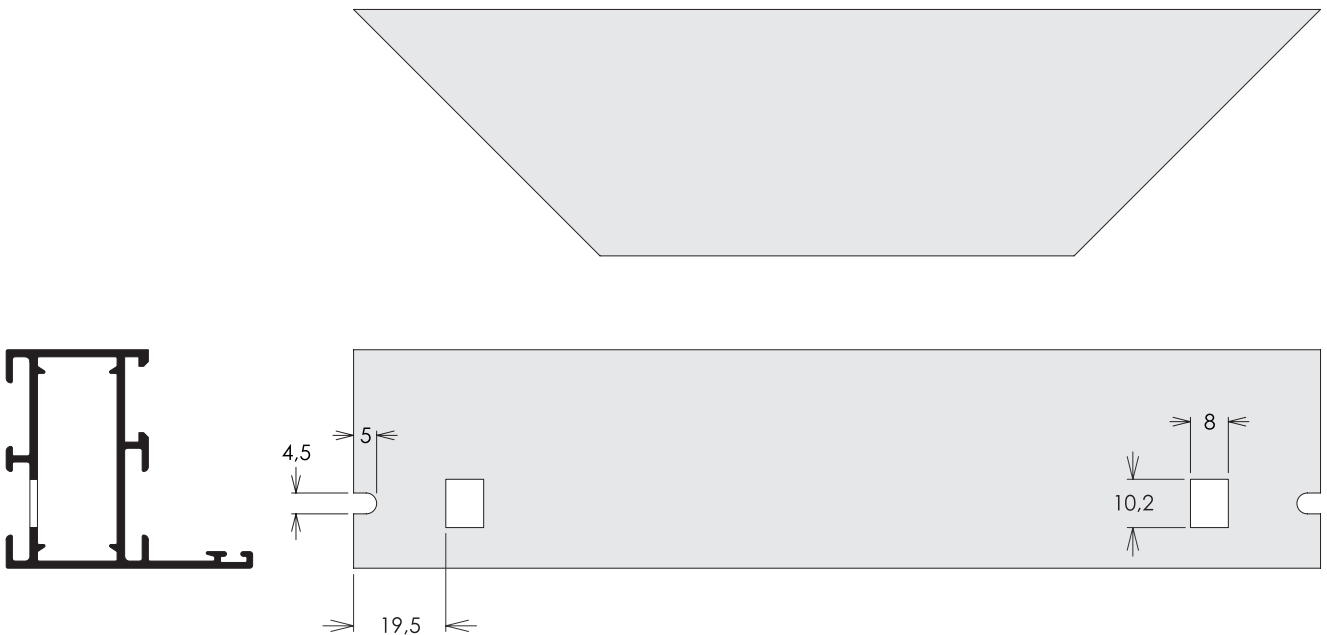

Usinar Perfis
RO008

USINAGENS PARA CREMONA E FECHO CONCHA

Usinar
Perfis
R0049

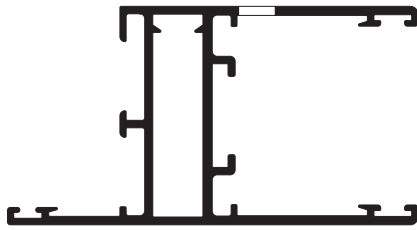

Cremona

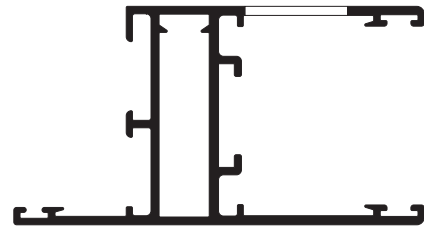

Fecho Concha

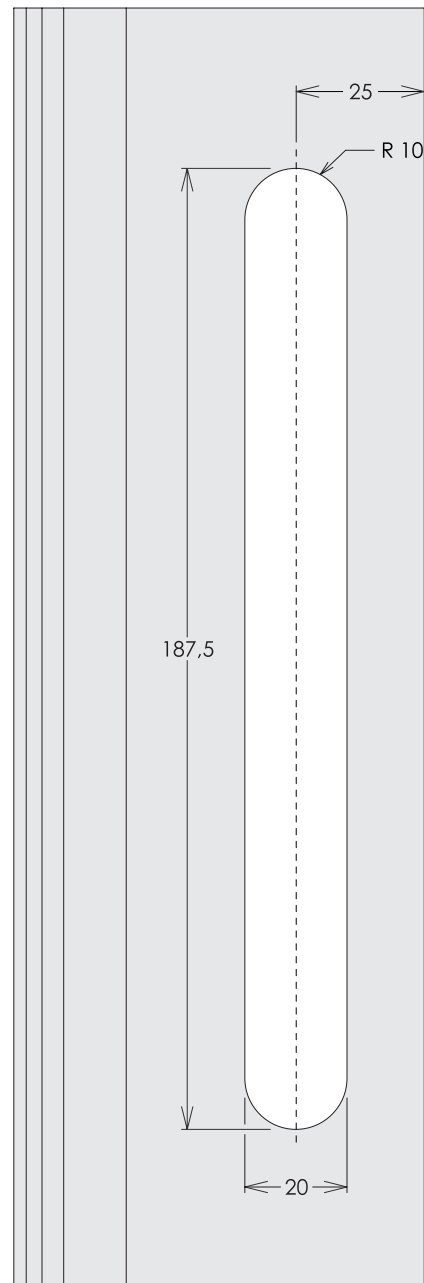
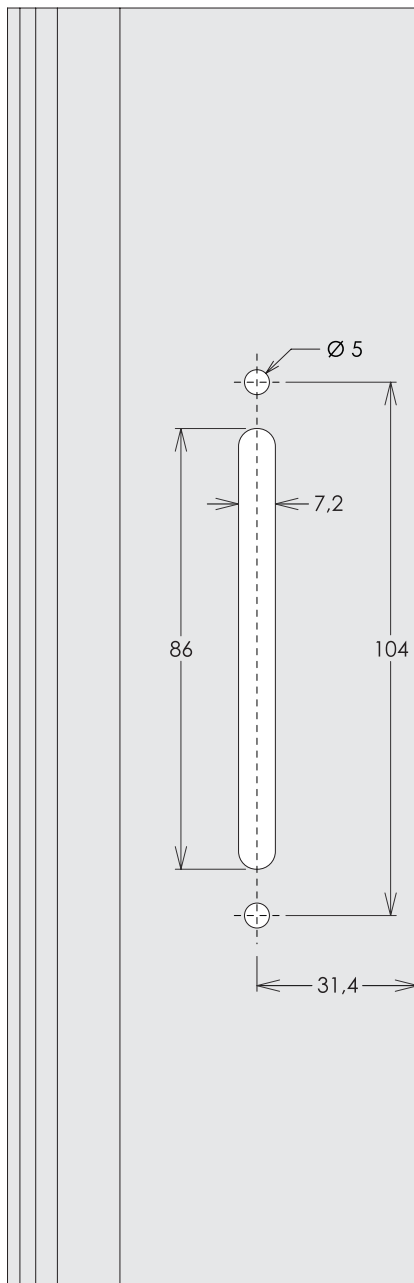

USINAGENS PARA FIXAÇÃO DA TRAVESSA - PORTA

Usinar
Perfis
RO049

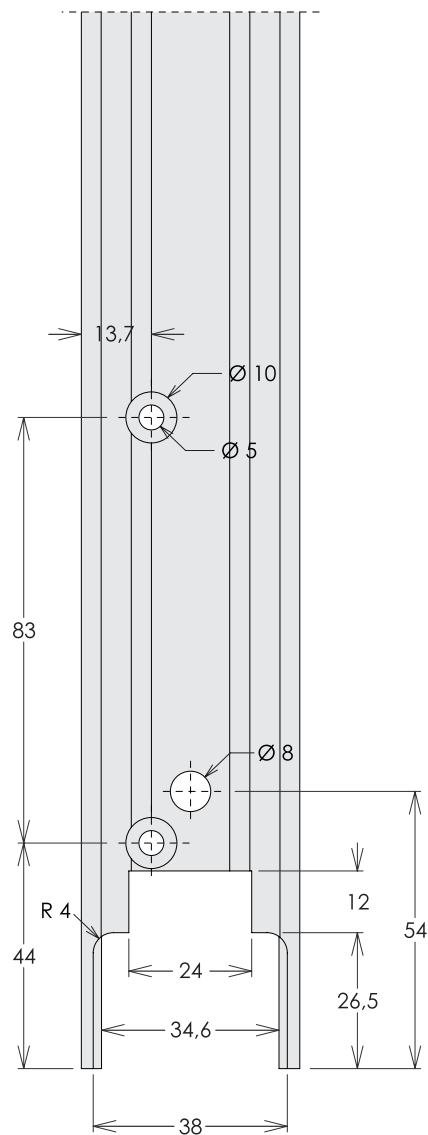
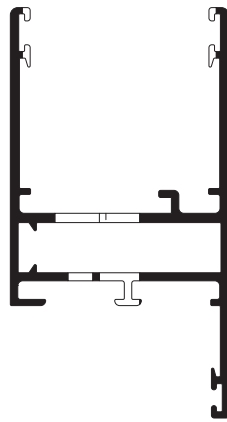

USINAGENS DA TAMPA SUPERIOR DE MONTANTE - PORTA

Usinar
Perfis
RO065

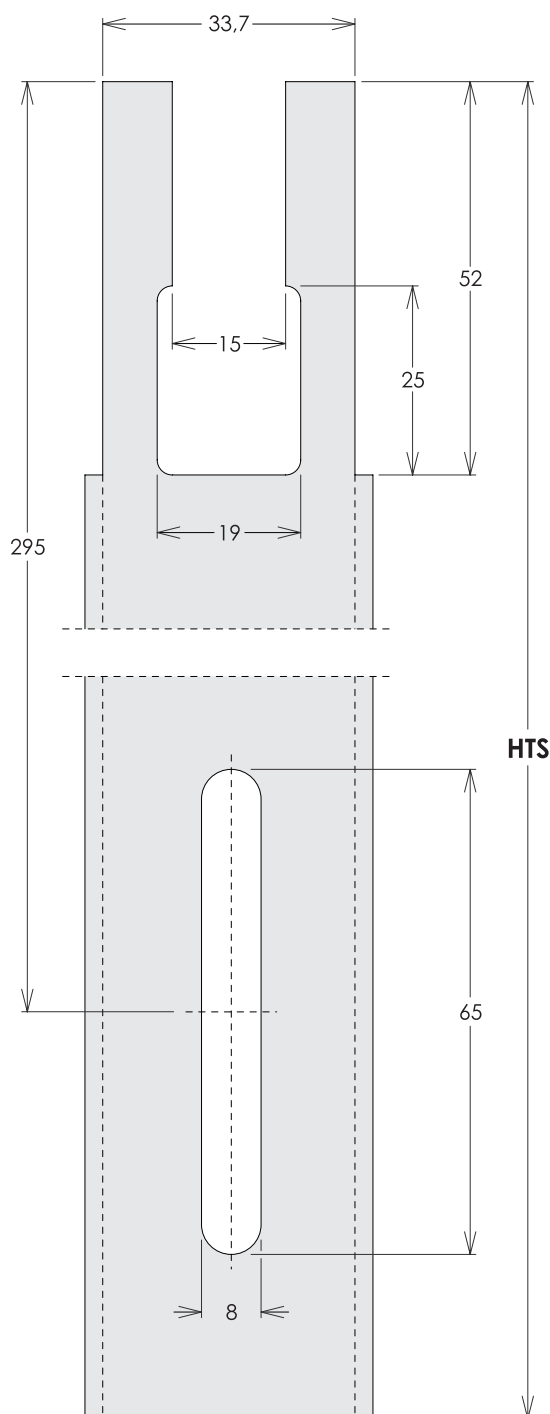

Cálculo da Altura da Tampa Superior

$$HTS = HF - HC - 126$$

Onde:
 HTS = Altura da Tampa Superior
 HF = Altura da Folha
 HC = Altura da Cremona

USINAGENS DA TAMPA SUPERIOR DE MONTANTE - JANELA

Usinar
Perfis
RO065

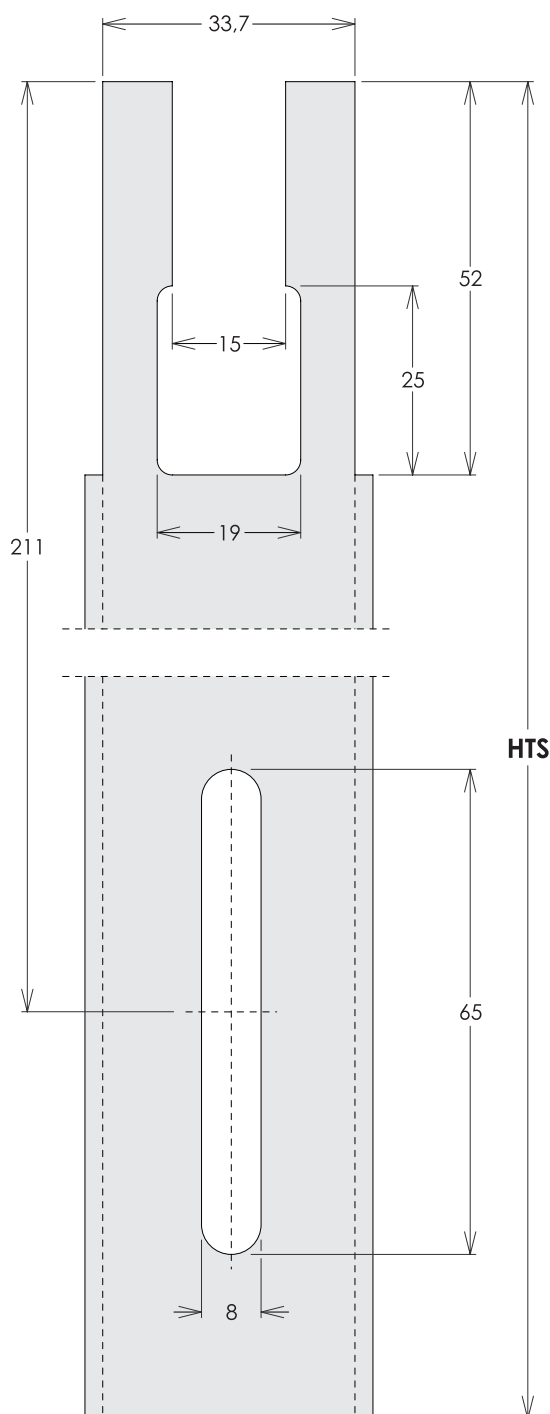

Cálculo da Altura da Tampa Superior

$$HTS = HF - HC - 126$$

Onde:
 HTS = Altura da Tampa Superior
 HF = Altura da Folha
 HC = Altura da Cremona

USINAGENS DA TAMPA SUPERIOR DE MONTANTE - JANELA

Usinar
Perfis
R0065

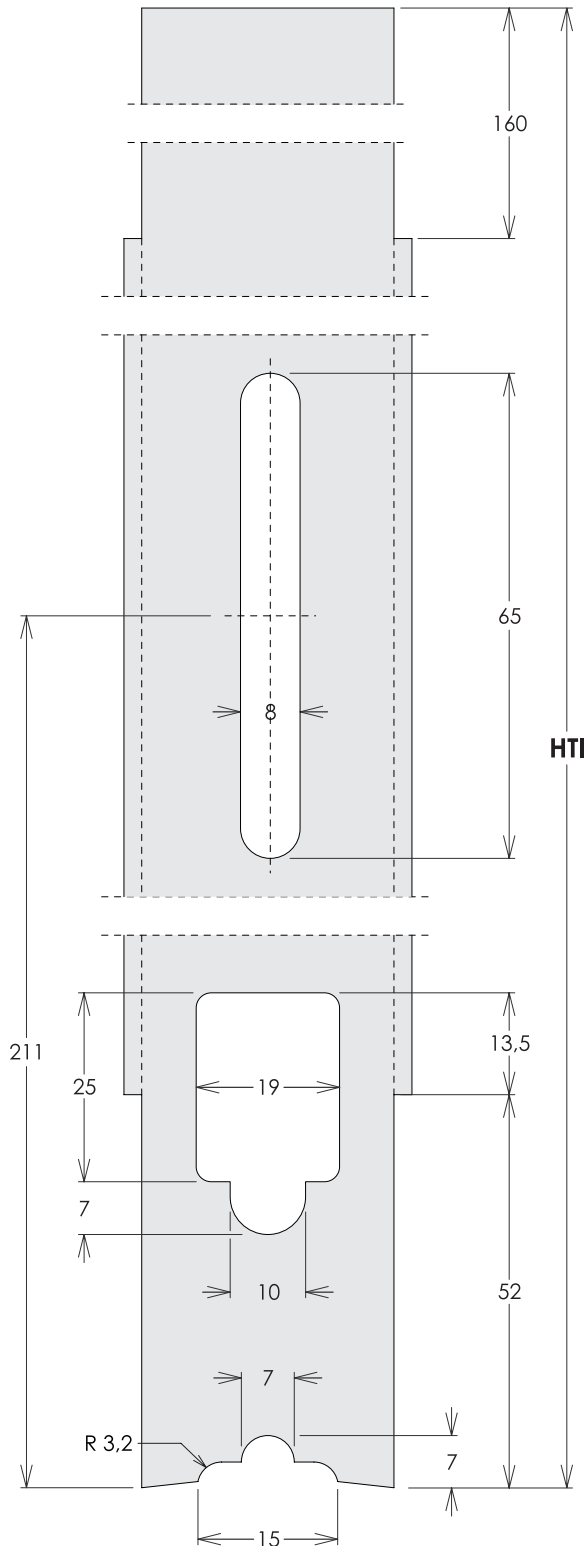

Cálculo da Altura da Tampa Superior

$$HTI = HC + 89$$

Onde:
HTI = Altura da Tampa Superior
HC = Altura da Cremona

SAÍDA DE ÁGUA - JANELA DE CORRER 2 FOLHAS

Usinar
Perfis
R0048
R0050
R0051

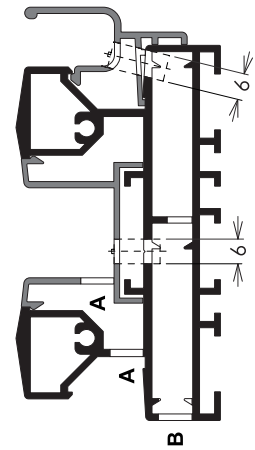
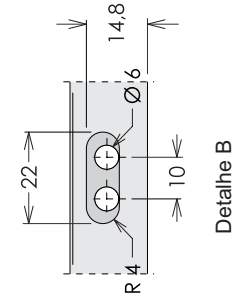
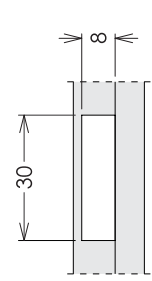
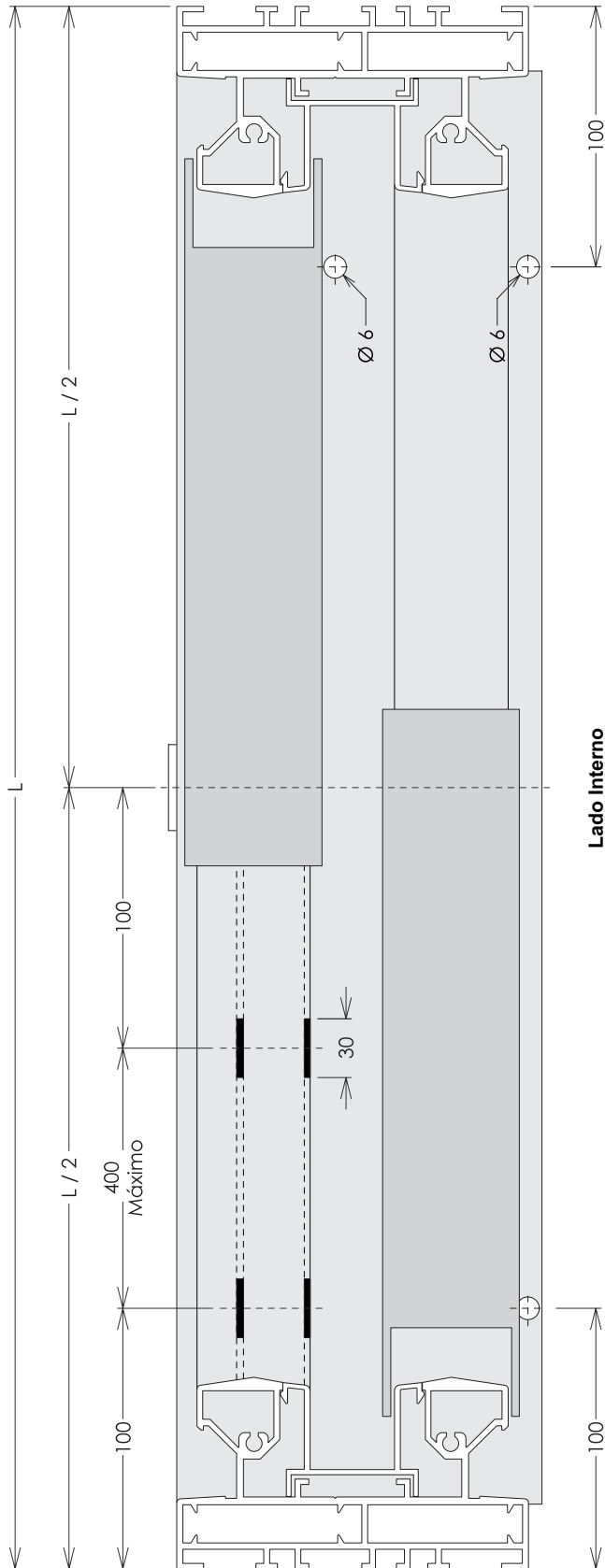

SAÍDA DE ÁGUA - JANELA DE CORRER 3 FOLHAS

Usinar
Perfis
R0048
R0050
R0051

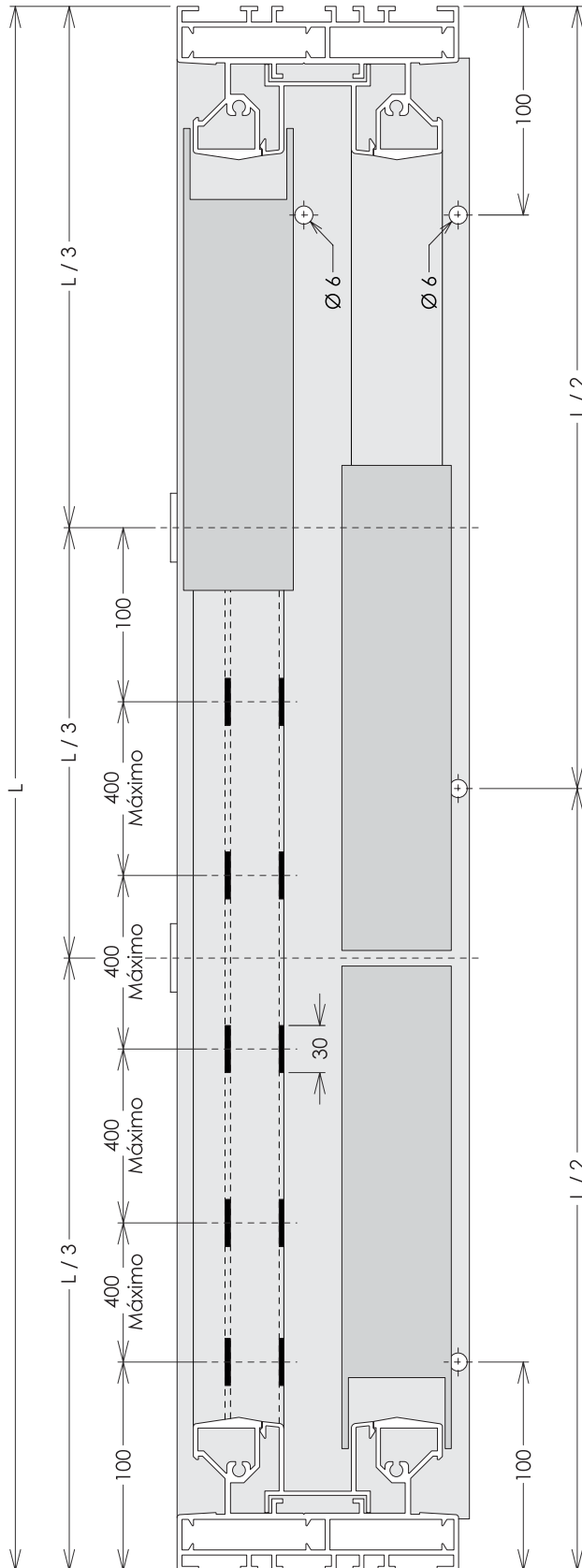

Lado Interno

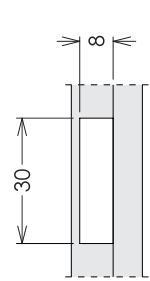

Detalhe A

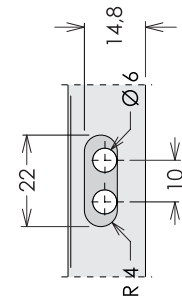

Detalhe B

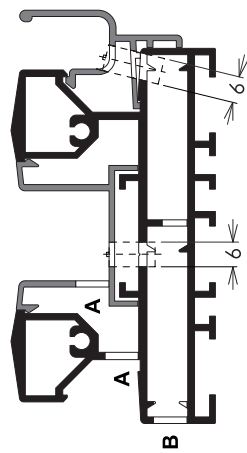

SAÍDA DE ÁGUA - JANELA DE CORRER 4 FOLHAS

Usinar
Perfis
R0048
R0050
R0051

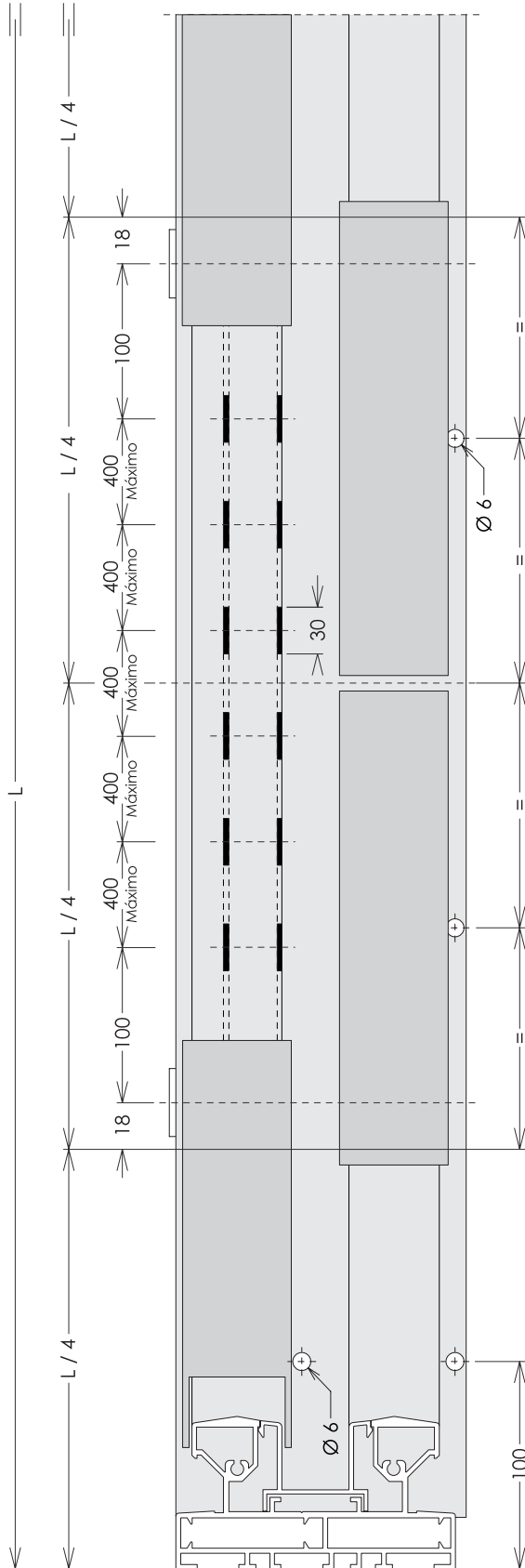

Lado Interno

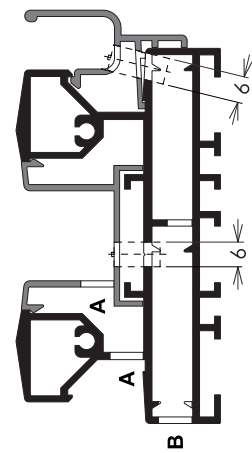
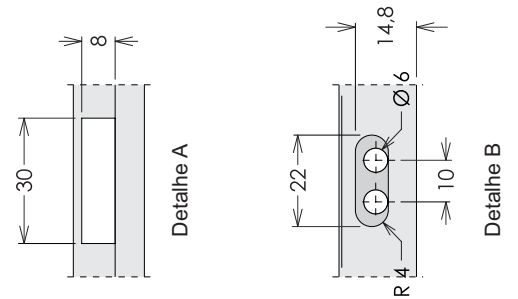

SAÍDA DE ÁGUA - PORTA DE CORRER 2 FOLHAS

Usinar
Perfis
R0052

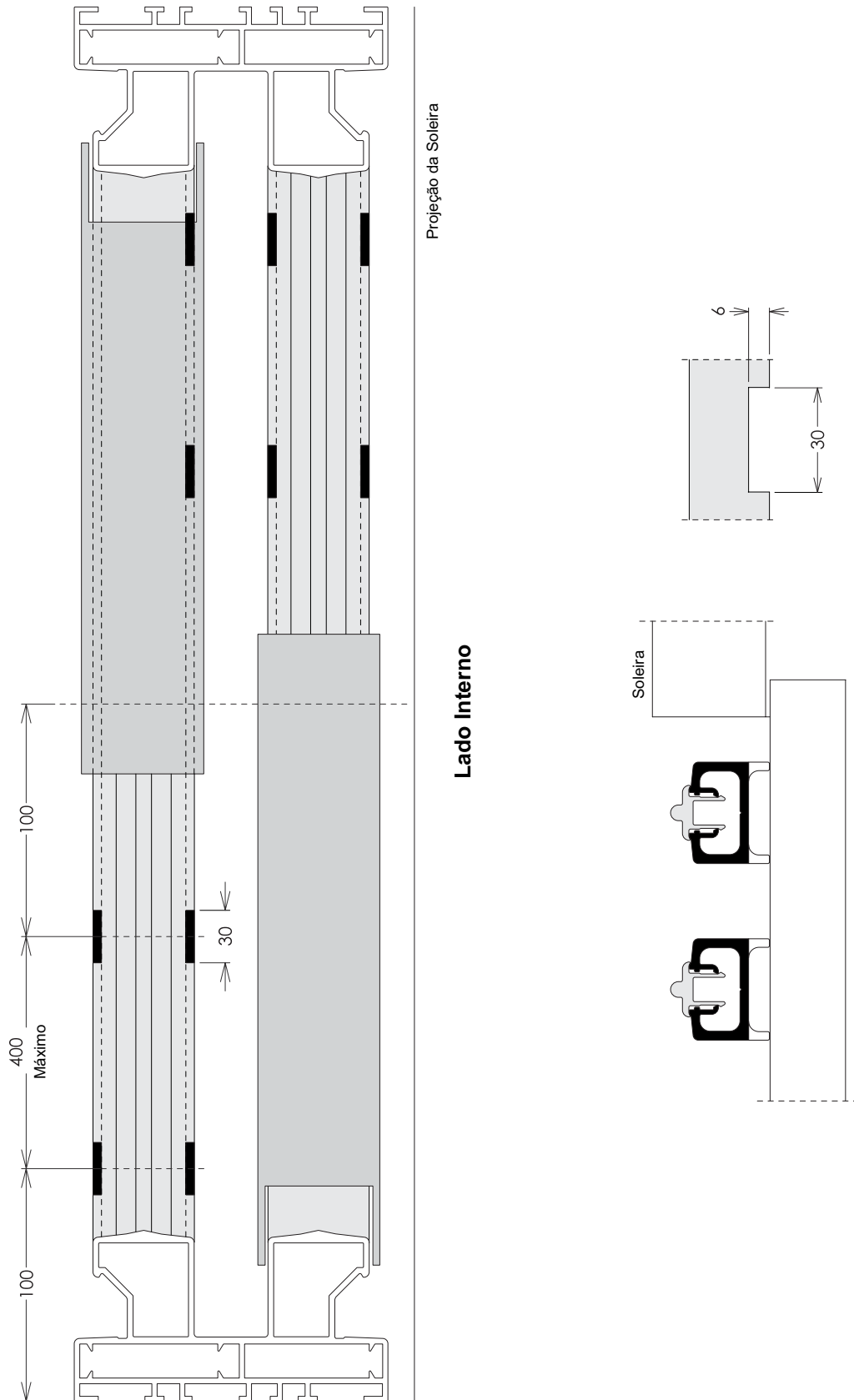

SAÍDA DE ÁGUA - PORTA DE CORRER 4 FOLHAS

Usinar
Perfis
R0052

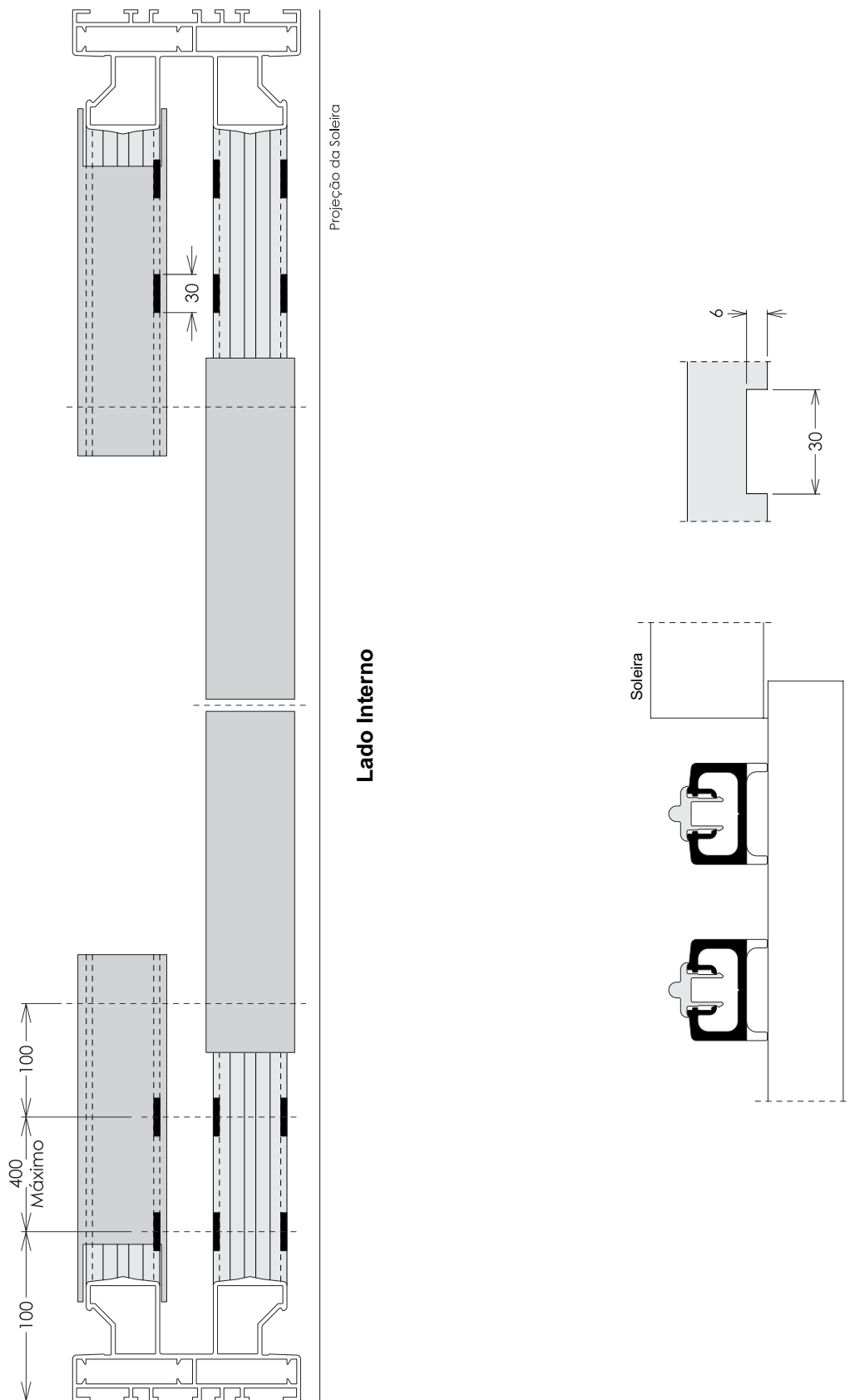

USINAGENS PARA FECHO MULTIPONTO - JANELA MAXIM-AR

Usinar
Perfis
R0021
R0080

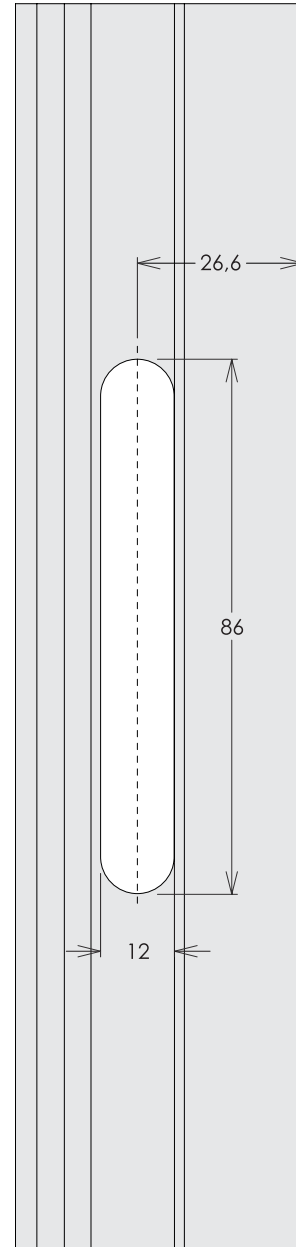
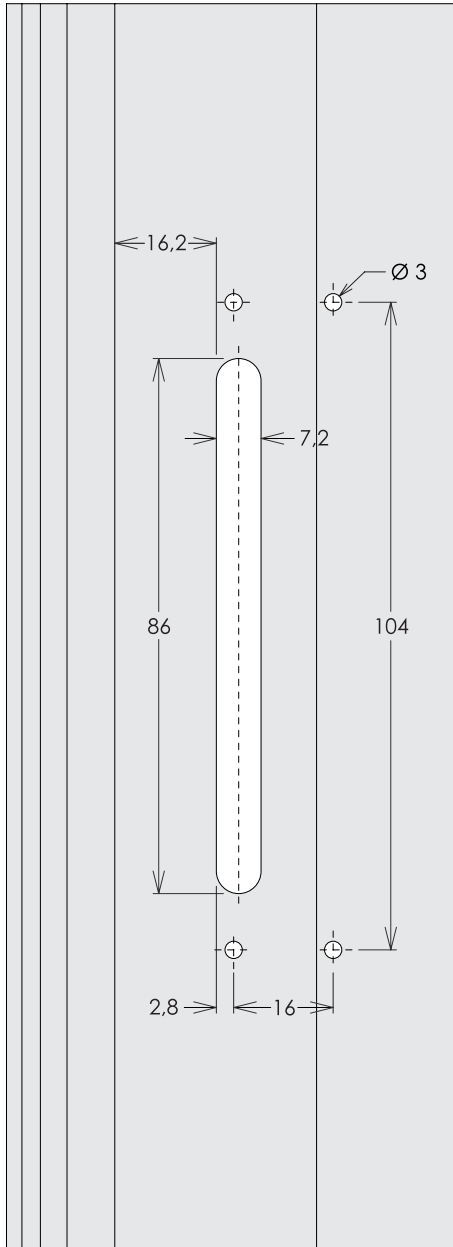
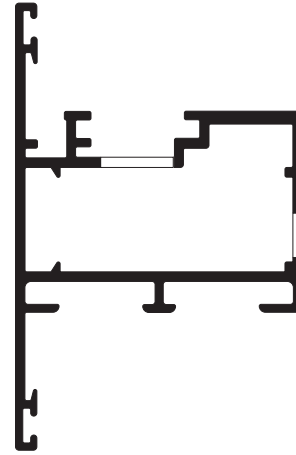
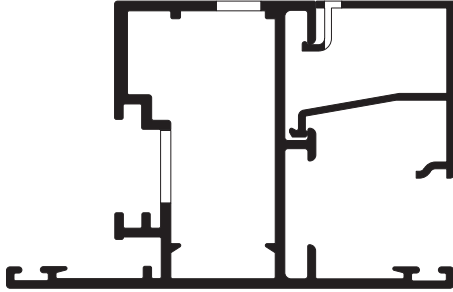

USINAGEM PARA CONTRAFECHO - CREMONA E CONCHA - PORTA

Usinar
Perfis
R0048

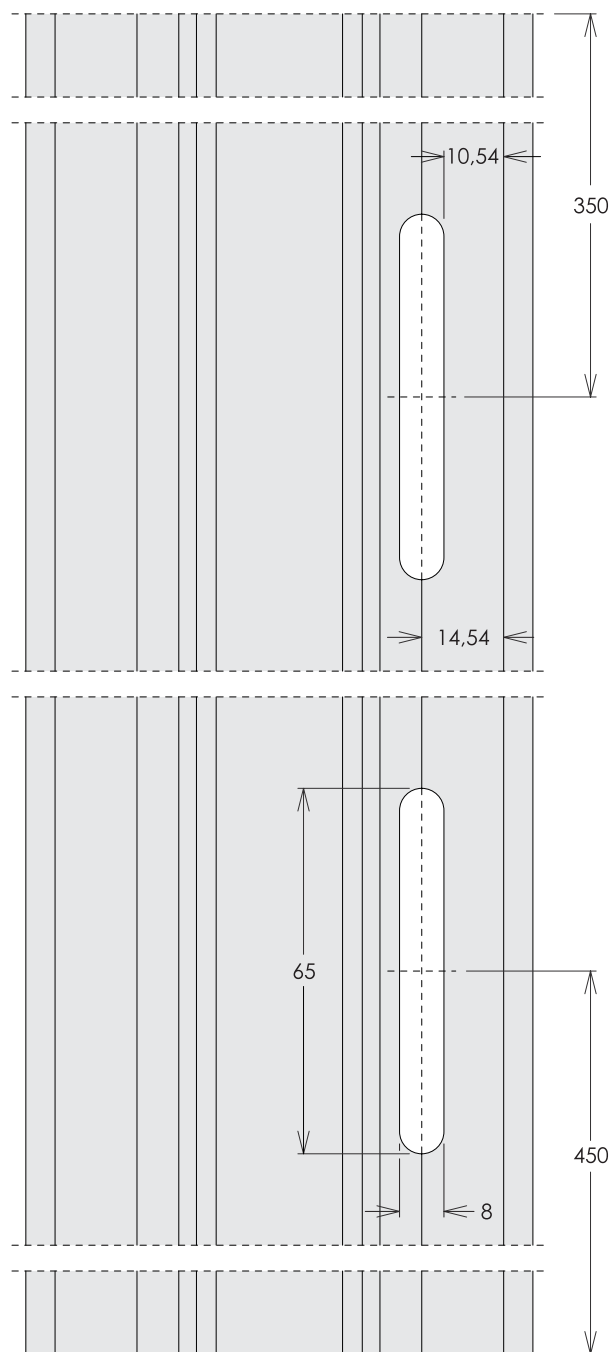
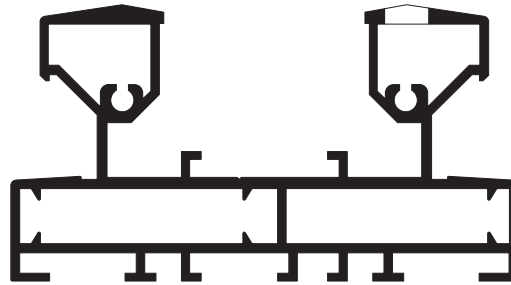

USINAGEM PARA CONTRAFECHO - CREMONA E CONCHA - JANELA

Usinar
Perfis
R0048

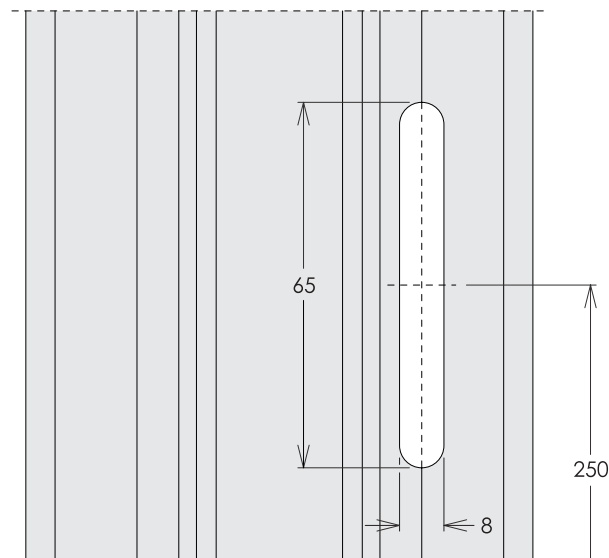
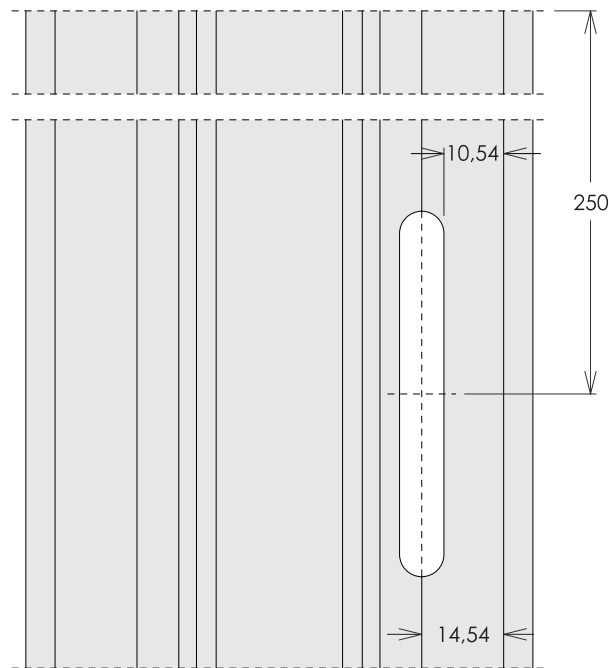
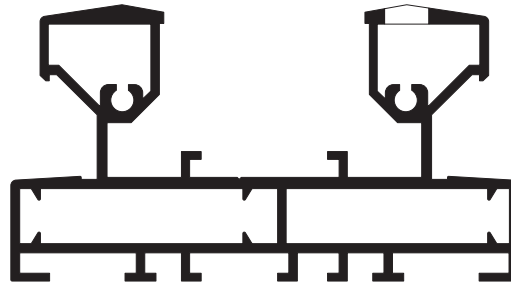

Lado Inferior

USINAGENS PARA FECHADURA - PORTA DE GIRO

Usinar
Perfis
RO032
RO042

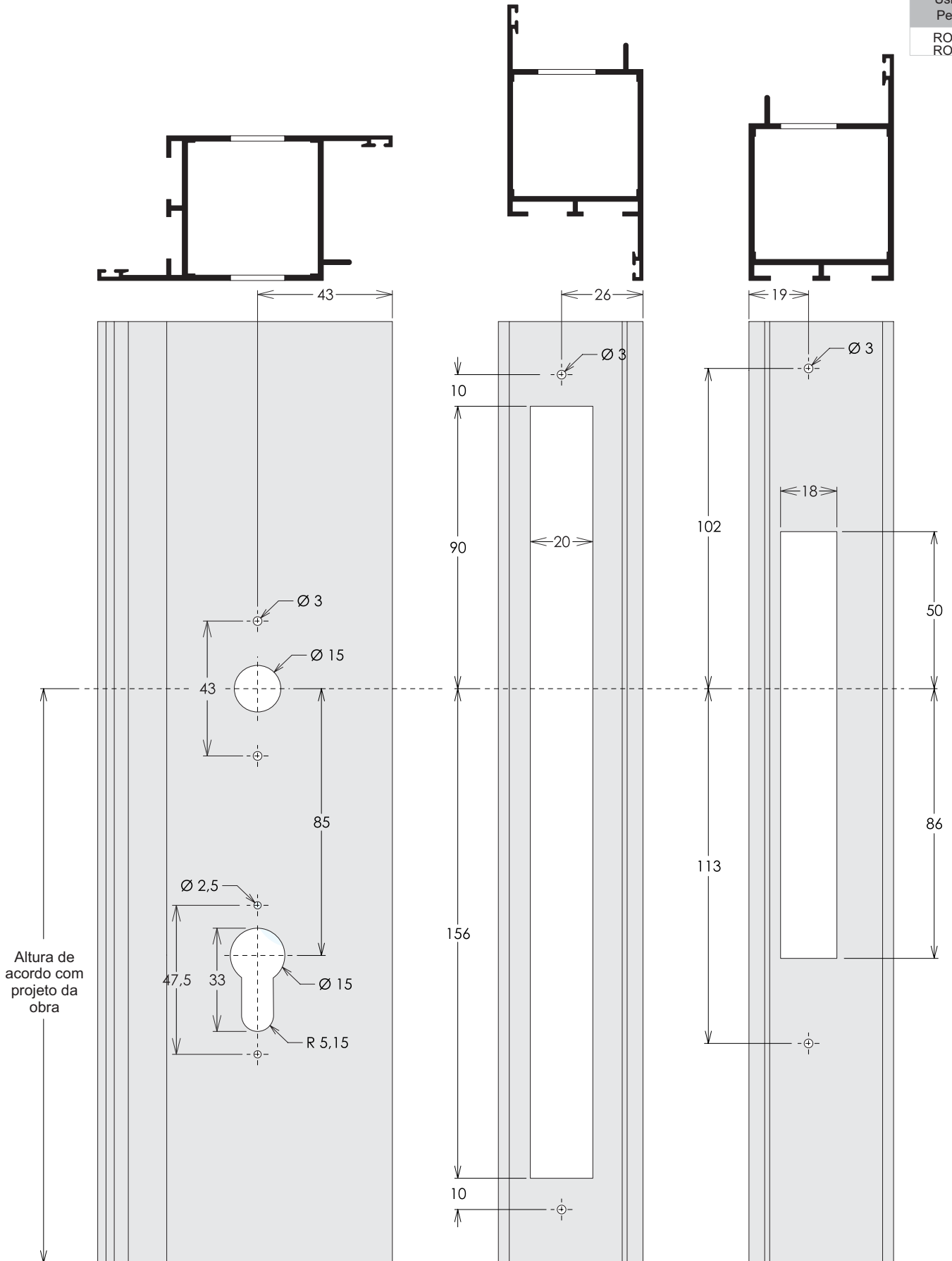

USINAGENS PARA FECHADURA - PORTA DE GIRO

Usinar
Perfis
R0032
R0042

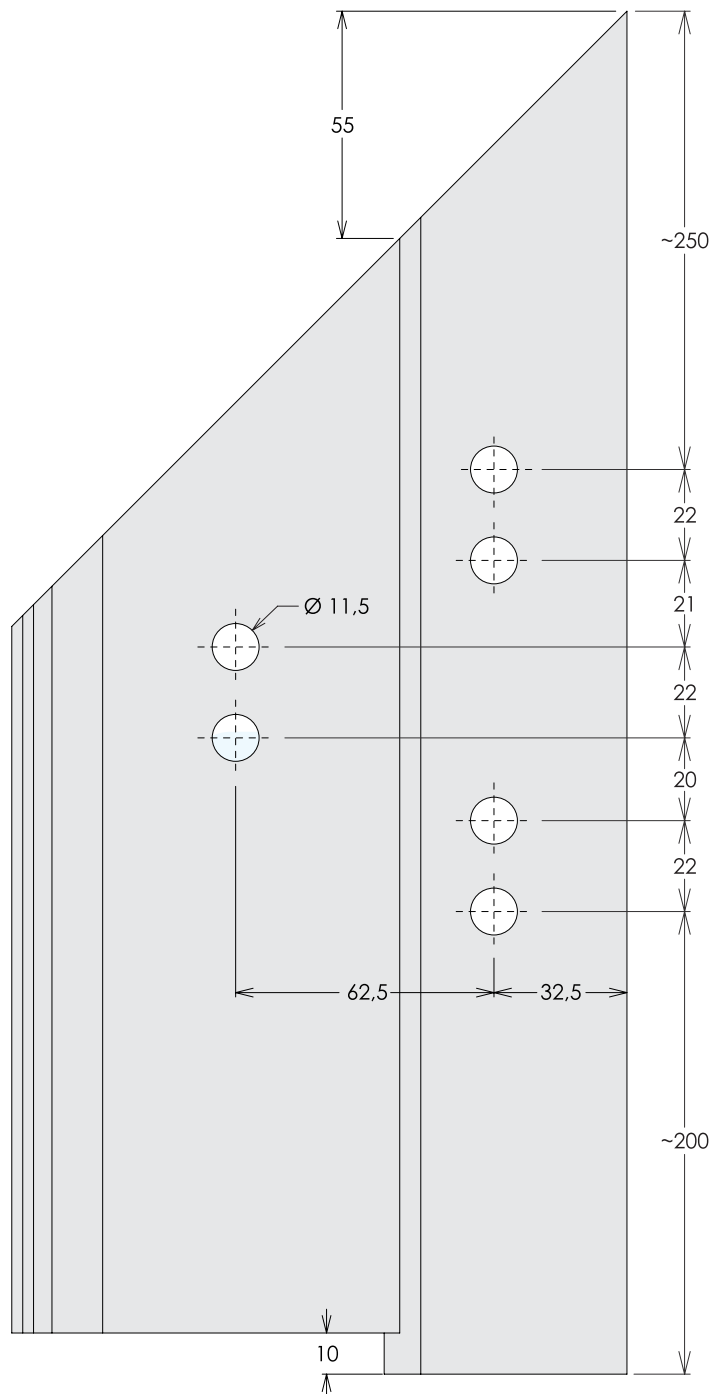
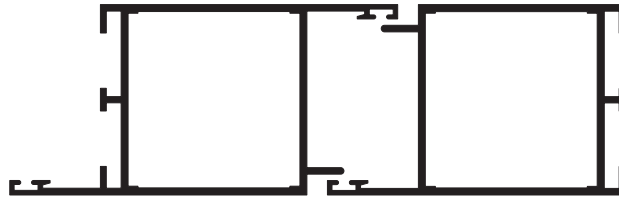

Não fazer esta usinagem quando utilizar dobradiça de duas abas

USINAGEM DA TRAVESSA E ROLDANA

Usinar
Perfis
R0063

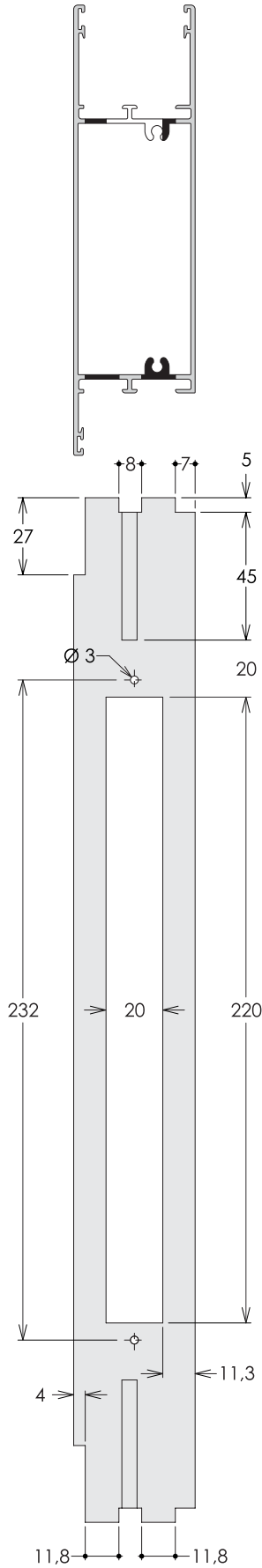

MÃO-DE-AMIGO - PORTA ELEVÁVEL

Usinar
Perfis
R0094

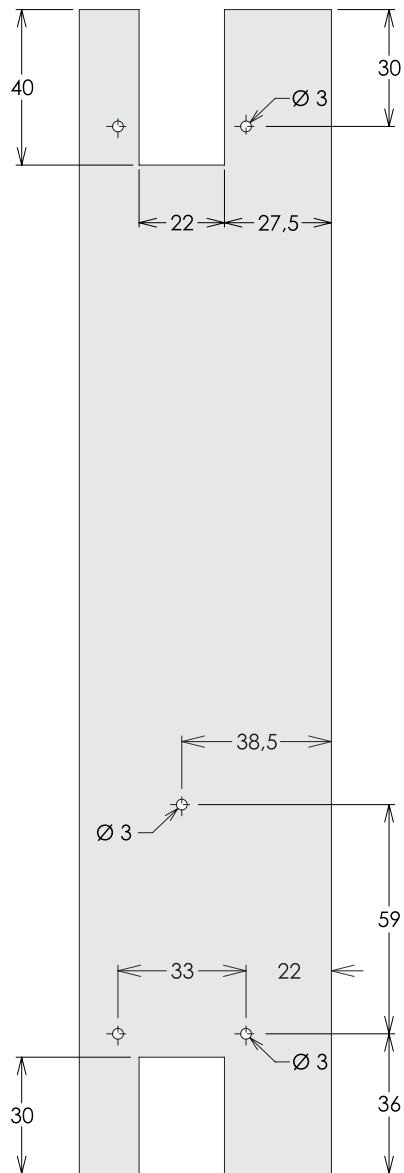
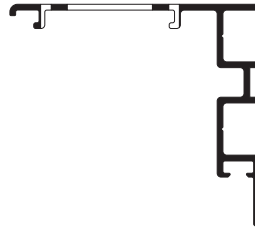

Lado Inferior

USINAGENS PARA CREMONA INTERNA - PORTA ELEVÁVEL

Usinar
Perfis
R0092

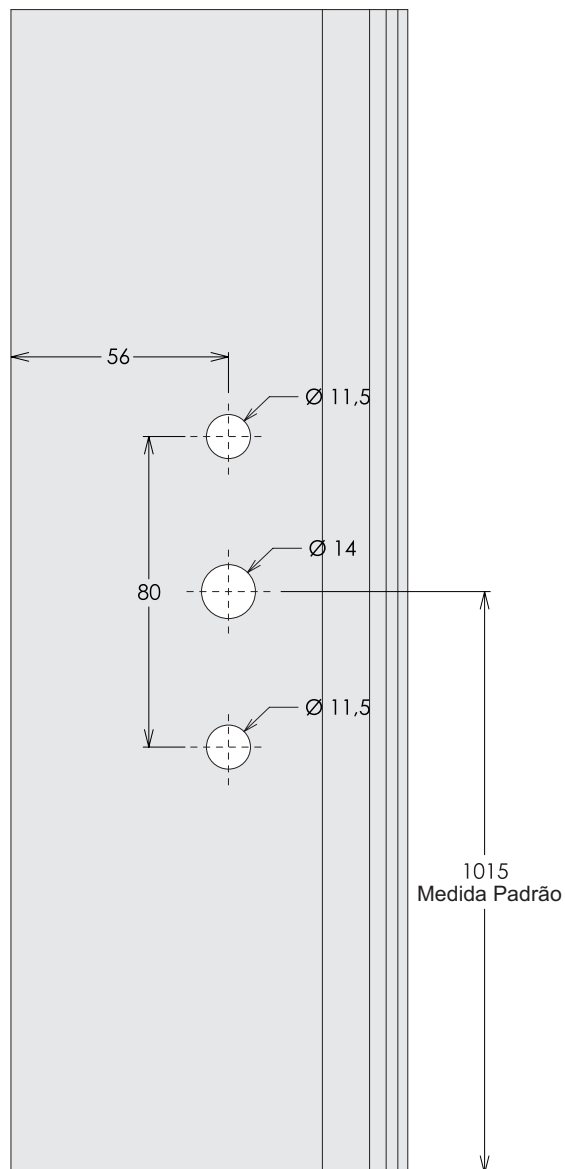
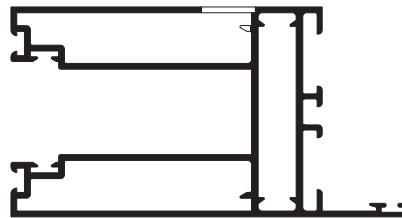

Lado Inferior

USINAGENS PARA CONCHA EXTERNA - PORTA ELEVÁVEL

Usinar
Perfis
RO092

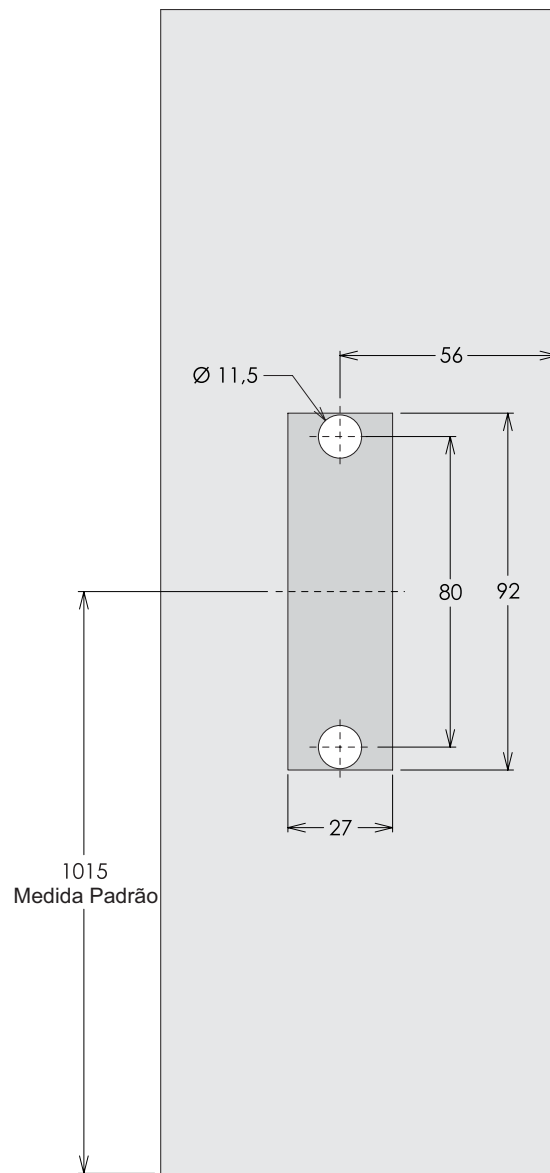
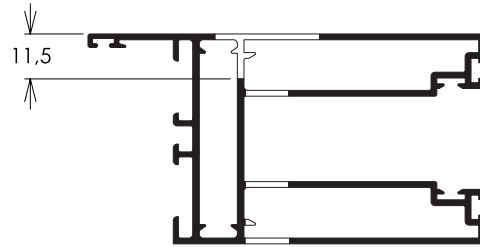

Lado Inferior

USINAGENS PARA FECHADURA - PORTA ELEVÁVEL

Usinar
Perfis
RO092

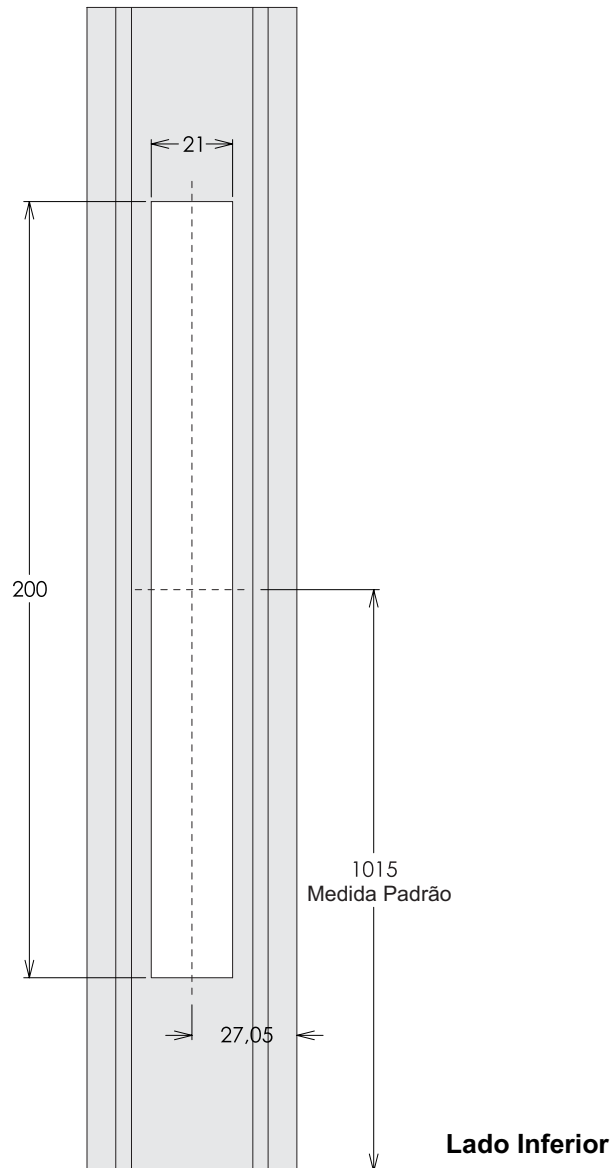
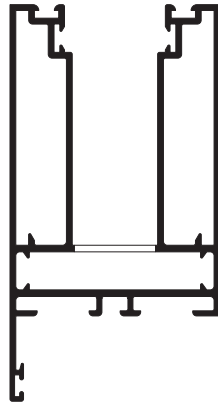

Usinagem de topo - Travessa

Fresa:
MAQ845

Usina perfis:
T69

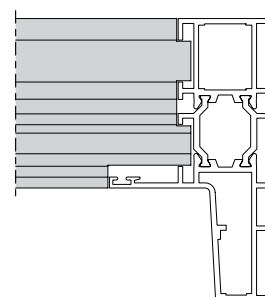
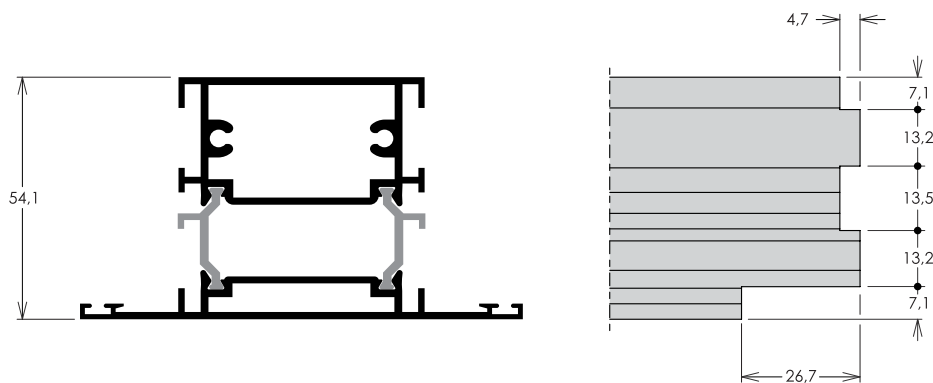

Aplicação

NOTA:

Perfil aplicado somente em janela ou porta com bandeira ou peitoril fixo.

Usinagem de topo - Travessa

Fresa:
MAQ846

Usina perfis:
RO062
RO063
RO147
T68
T70

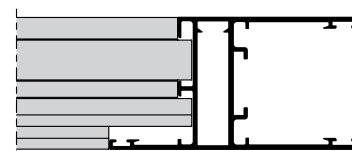
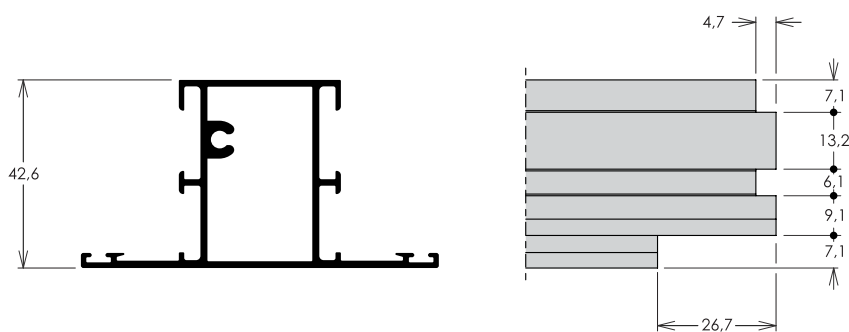

Aplicação

Usinagem de topo - Travessa

Fresa:
MAQ847

Usina perfis:
T84

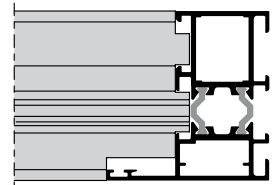
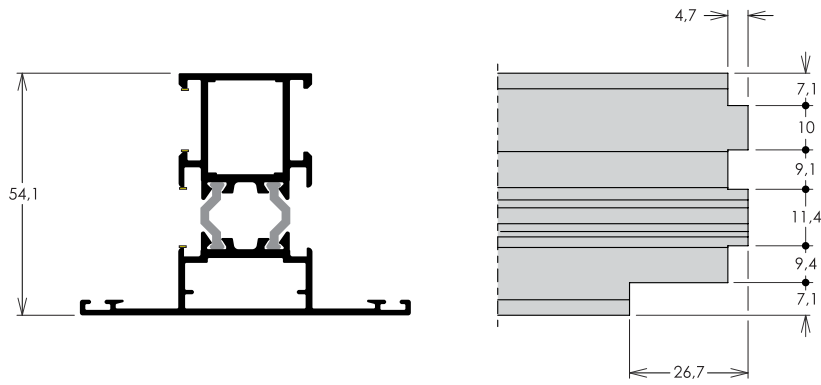

Aplicação

Usinagem de topo - Travessa

Fresa:
MAQ848

Usina perfis:
RO079
T91

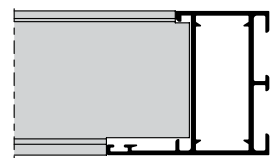
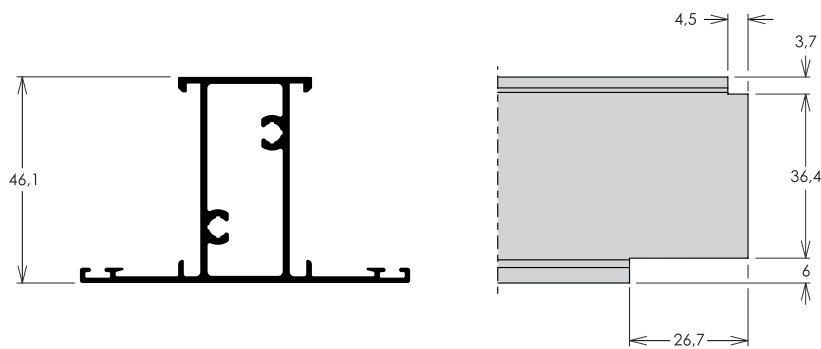

Aplicação

Usinagem de topo - Travessa

Fresa:
MAQ844

Usina perfis:
RO012
RO013
RO014
RO033
RO034
RO044
RO045
RO125
T77
T82
T83

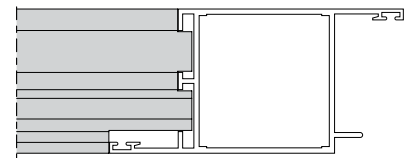
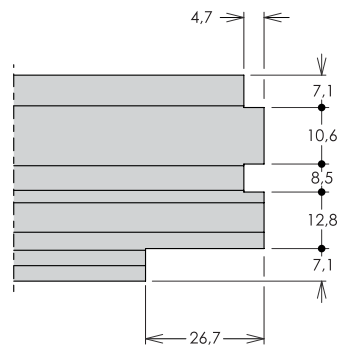
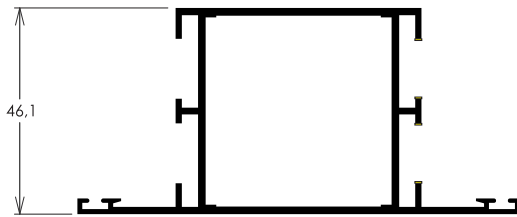

Aplicação

Descrição	Pág.
JANELA OSCILO BATENTE 1 FOLHA	J-01
JANELA OSCILO BATENTE 2 FOLHAS	J-01
JANELA MAXIM-AR 1 FOLHA	J-01
JANELA DE CORRER 2 FOLHAS	J-01
KIT PARA JANELA OSCILO BATENTE 1 FOLHA - CONJUNTO MECANISMO BASE	J-02
DETALHE DE MONTAGEM DO KIT COMPLEMENTAR DO FECHO - JANELA OSCILO BATENTE 2 FOLHAS	J-03
DETALHE DE MONTAGEM DO KIT COMPLEMENTAR DO FECHO - JANELA DE GIRO 1 FOLHA	J-04
DETALHE DE MONTAGEM DO KIT COMPLEMENTAR DO FECHO - JANELA DE GIRO 2 FOLHAS	J-05
POSIÇÕES DE MANOBRA - PORTA OSCILO PARALELA COM FOLHA FIXA	J-06
FEC1106 - FECHO CONCHA COM MULTIPONTO	J-07
POSIÇÕES DOS COMPONENTES - PORTA OSCILO PARALELA COM FOLHA FIXA E MÓVEL	J-08
DETALHE DE JUNÇÃO CENTRAL - ELEVÁVEL	J-09
DETALHE DE USINAGENS E MONTAGENS - ELEVÁVEL	J-10
VEDAÇÃO NO TRILHO DA JANELA - DETALHE PARA VEDAÇÃO DO TRILHO	J-11
POSICIONAMENTO DOS CALÇOS DOS VIDROS	J-12
ALTERNATIVAS CONSTRUTIVAS - GUARNIÇÕES PARA VIDRO	J-13

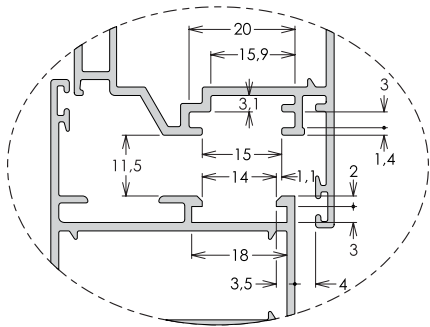

Detalhe A

**Janela Oscilo Batente
01 Folha**

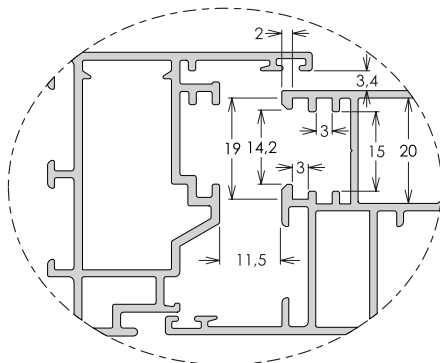
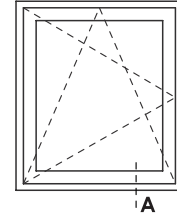

Detalhe B

**Janela Oscilo Batente
02 Folhas**

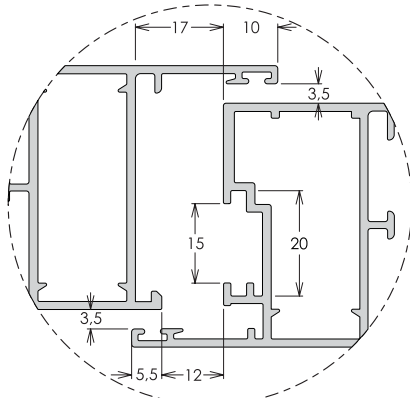
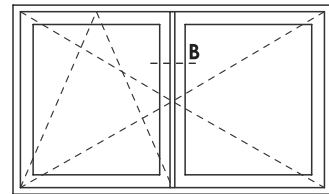

Detalhe C

**Janela Maxim-ar
01 Folha**

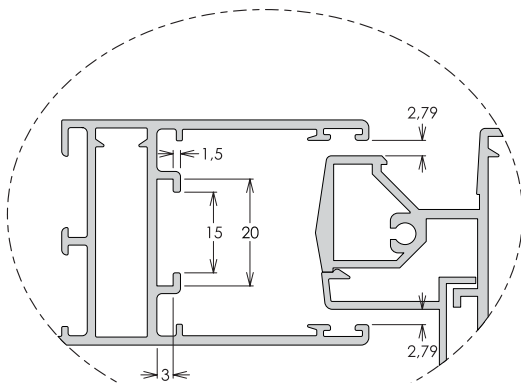
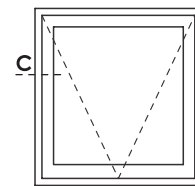

Detalhe D

**Janela de Correr
02 Folhas**

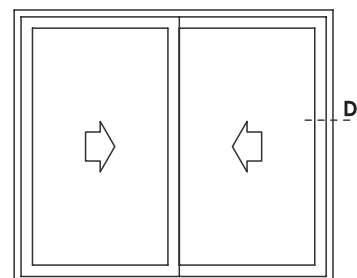

Kit para Janela Oscilo Batente

1 folha (com e sem Thermal Break)
 Conjunto Macanismo Base
 Materiais diversos - Branco ou Preto

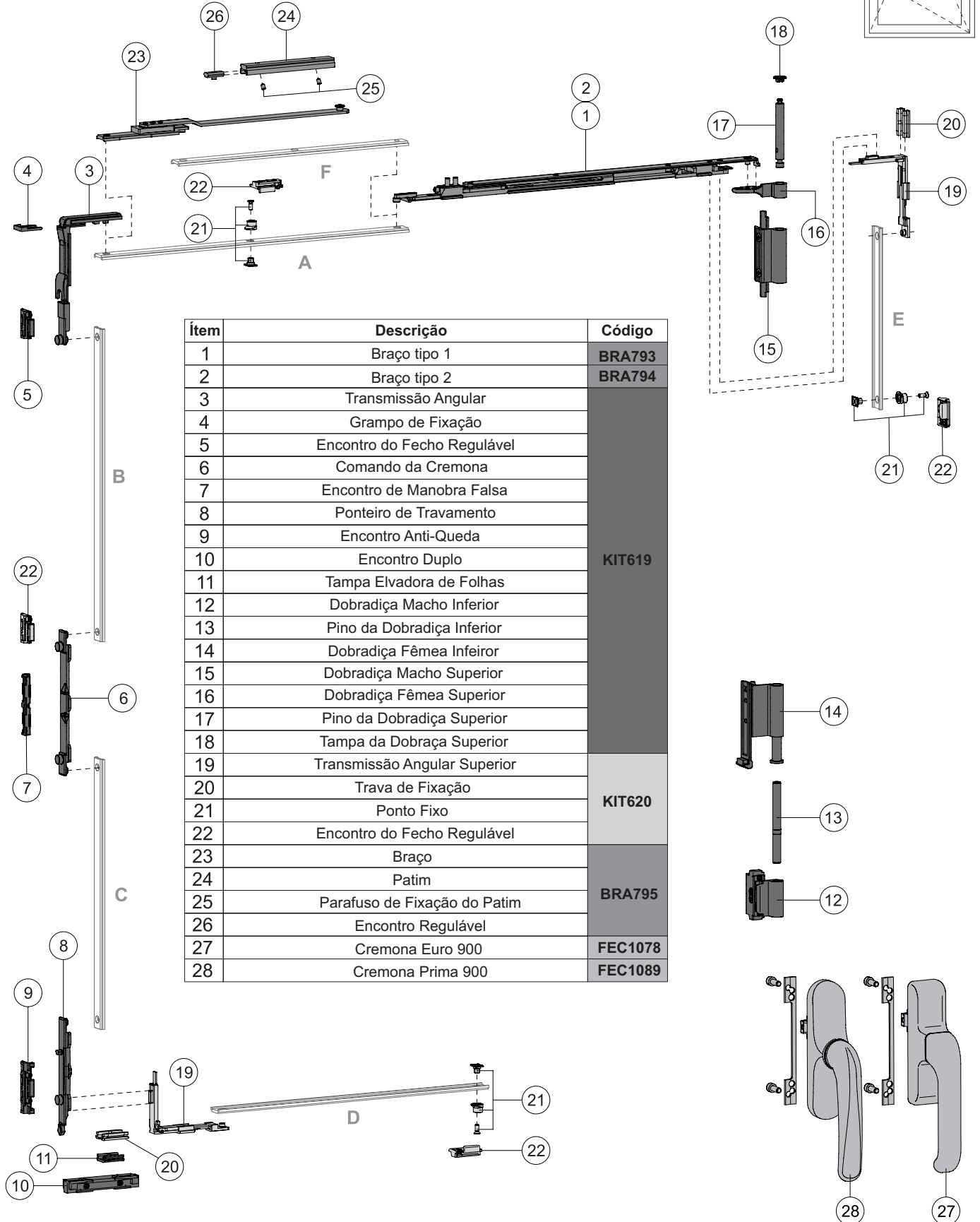

Ítem	Descrição	Código
1	Braço tipo 1	BRA793
2	Braço tipo 2	BRA794
3	Transmissão Angular	KIT619
4	Grampo de Fixação	
5	Encontro do Fecho Regulável	
6	Comando da Cremona	
7	Encontro de Manobra Falsa	
8	Ponteiro de Travamento	
9	Encontro Anti-Queda	
10	Encontro Duplo	
11	Tampa Elvadora de Folhas	
12	Dobradiça Macho Inferior	
13	Pino da Dobradiça Inferior	
14	Dobradiça Fêmea Inferior	
15	Dobradiça Macho Superior	KIT620
16	Dobradiça Fêmea Superior	
17	Pino da Dobradiça Superior	
18	Tampa da Dobraça Superior	
19	Transmissão Angular Superior	
20	Trava de Fixação	
21	Ponto Fixo	
22	Encontro do Fecho Regulável	
23	Braço	BRA795
24	Patim	
25	Parafuso de Fixação do Patim	BRA795
26	Encontro Regulável	
27	Cremona Euro 900	FEC1078
28	Cremona Prima 900	FEC1089

Detalhe de montagem do Kit Complementar do Fecho

Janela Oscilo Batente 2 folhas

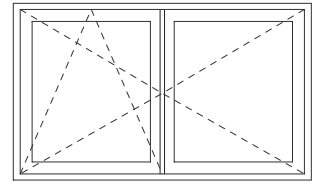

Corte A-A

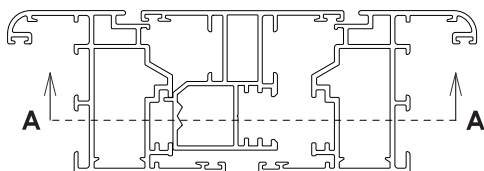
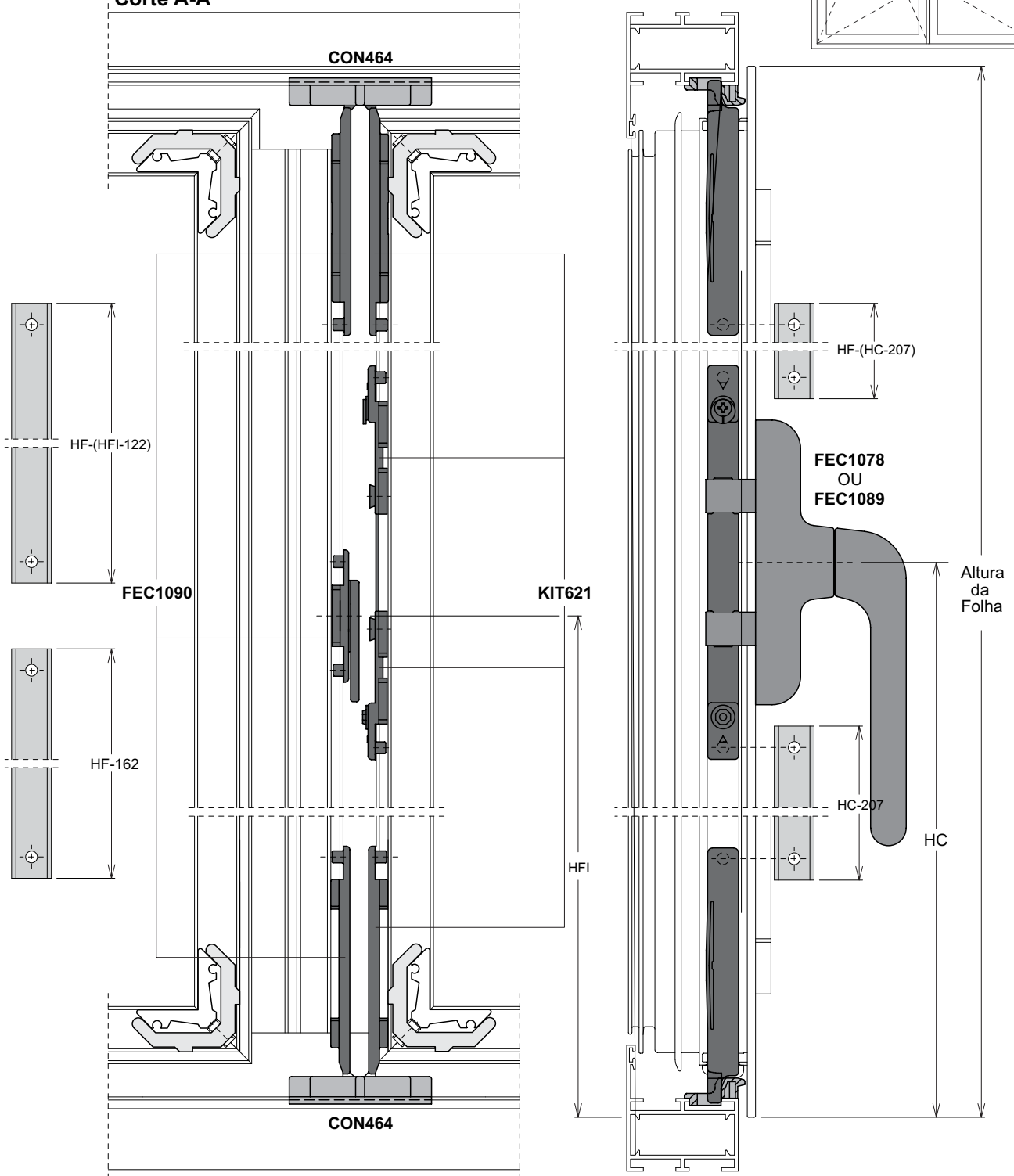

HF=Altura da Folha
 HC=Altura da Cremona
 HFI=Altura do Fecho Interno

Detalhe de montagem do Kit Complementar do Fecho

Janela de Giro 1 folha

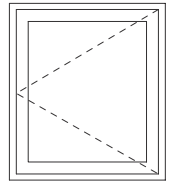

Corte A-A

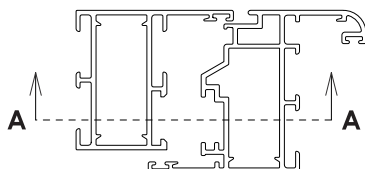
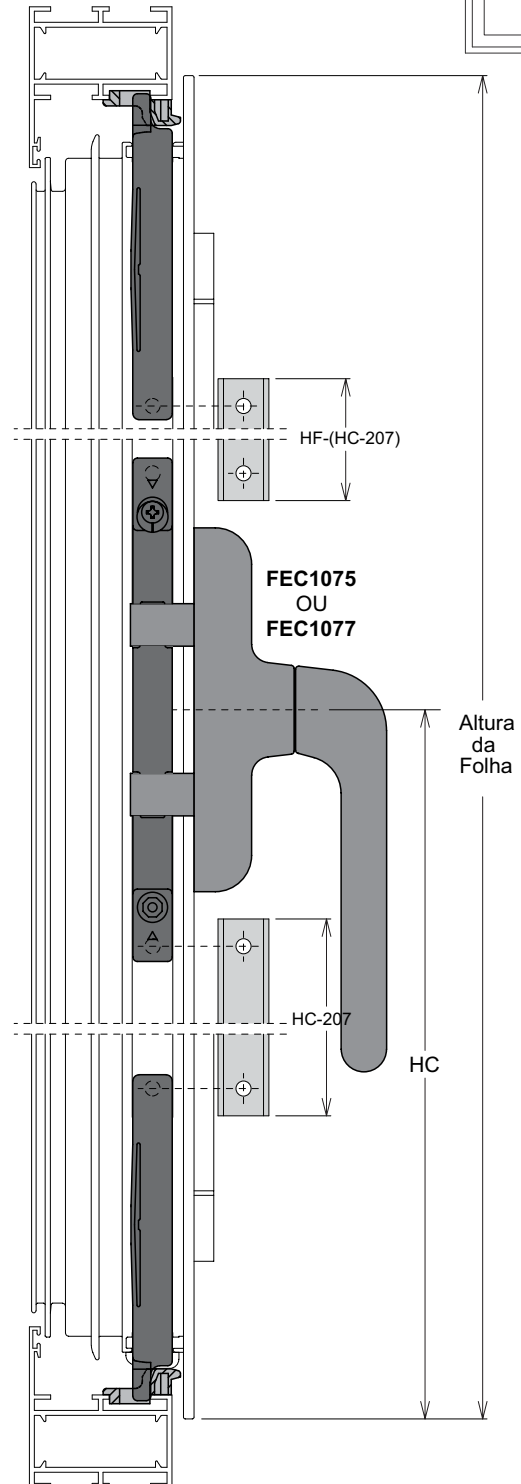
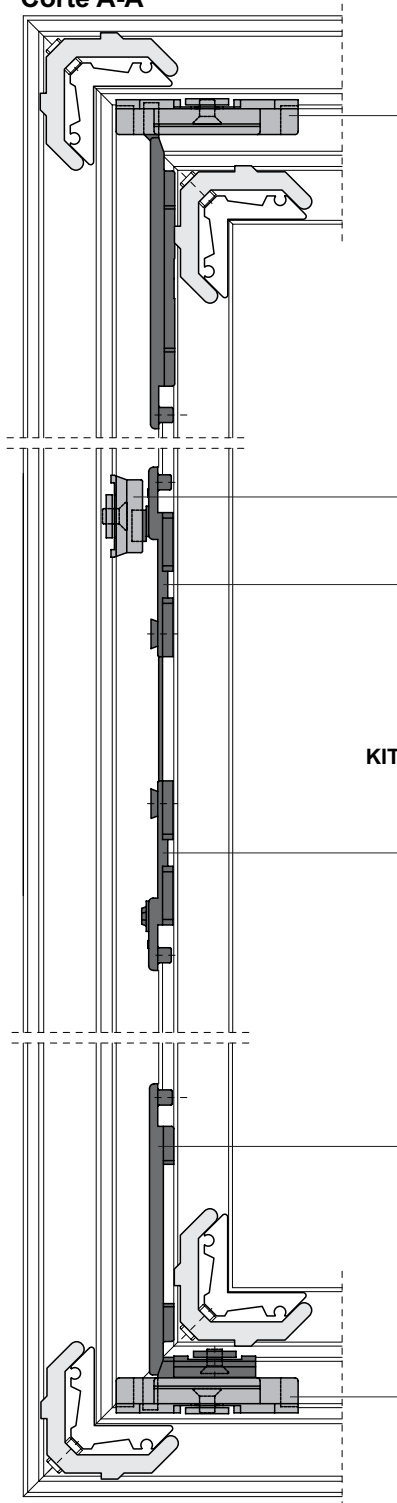

HF=Altura da Folha
HC=Altura da Cremona

Detalhe de montagem do Kit Complementar do Fecho

Janela de Giro 2 folha

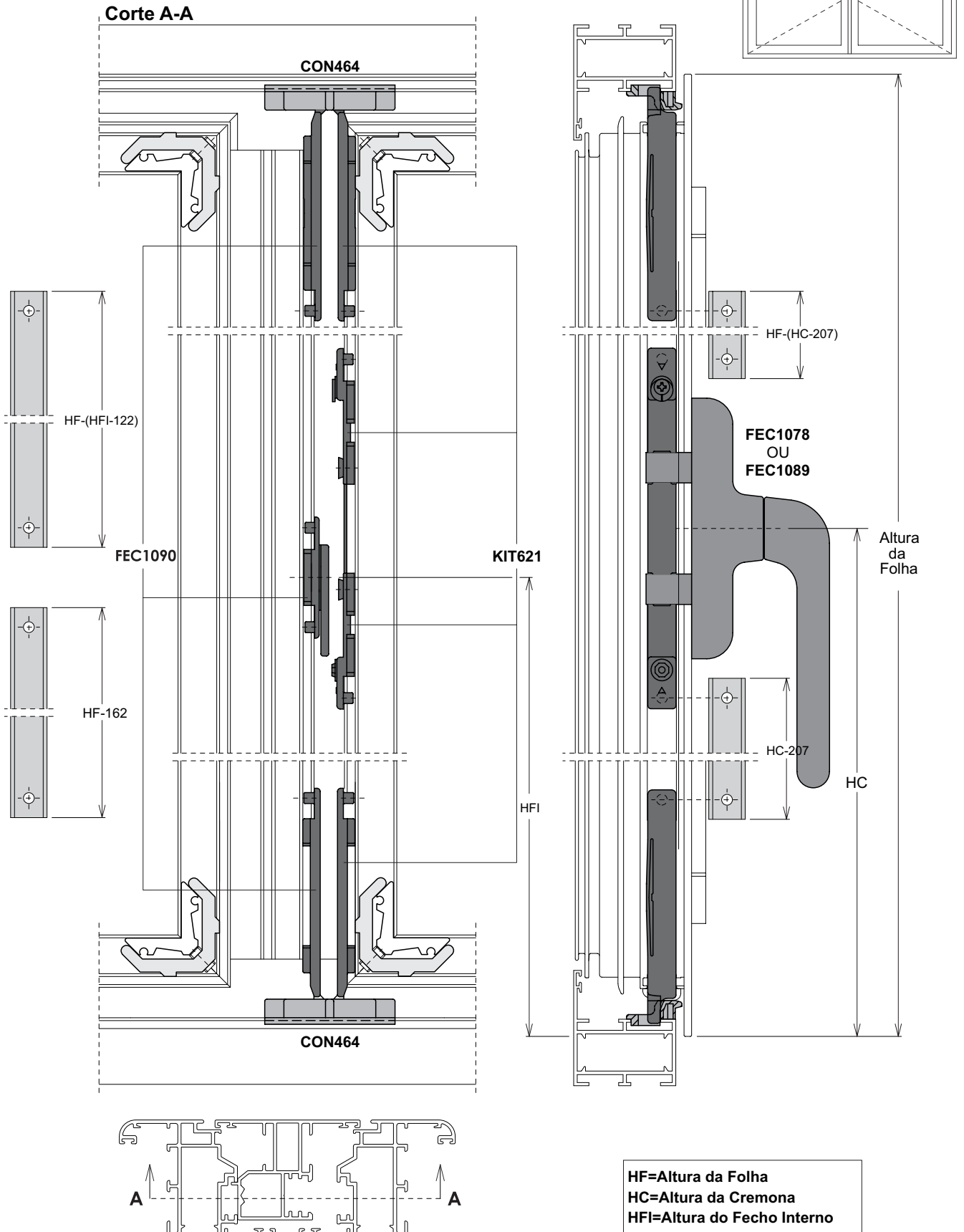

Posições de manobra

Porta Oscilo Paralela com Folha Fixa

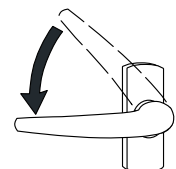
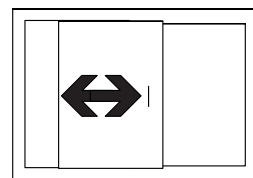
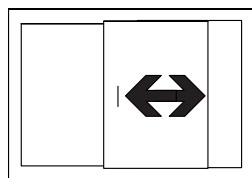
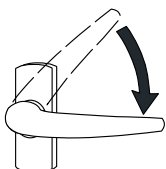
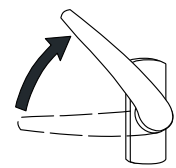
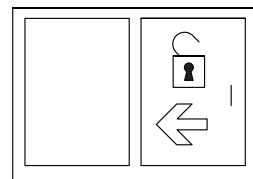
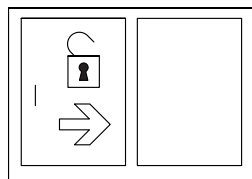
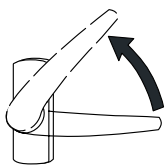
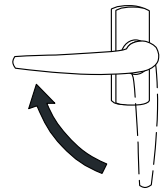
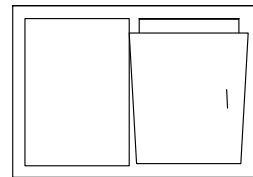
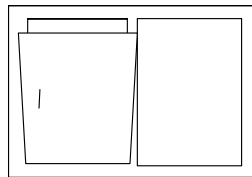
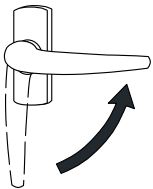
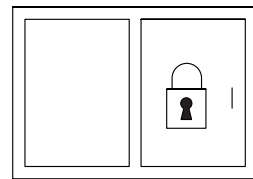
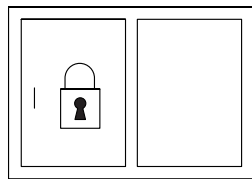
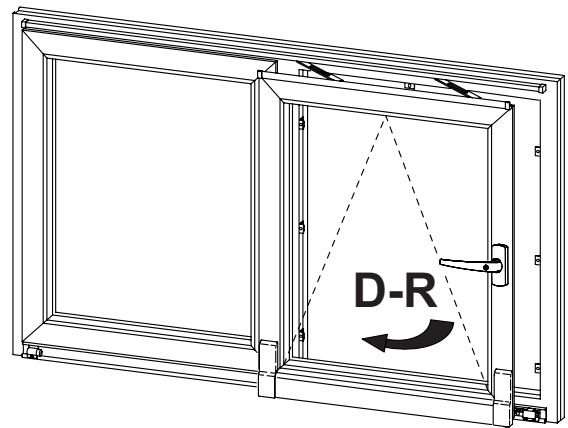
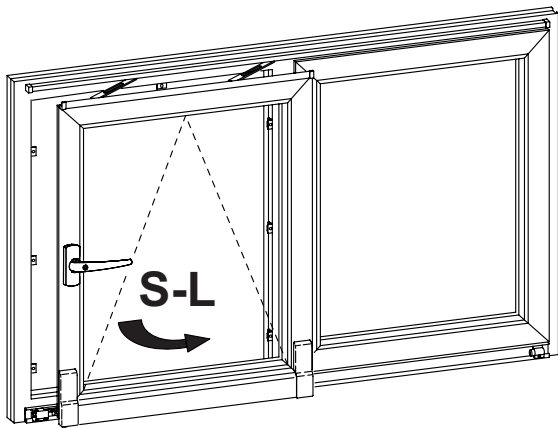

FEC1106

Fecho concha com multiponto
Alumínio Branco ou Preto

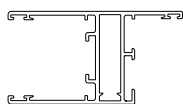
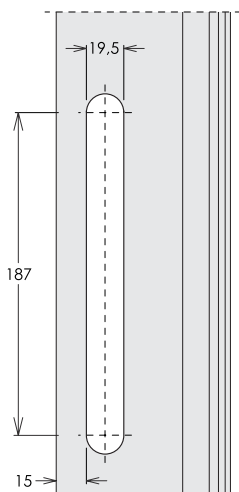
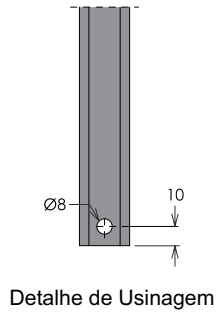
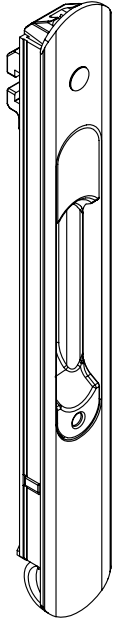

Detalhe de Usinagem

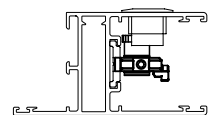
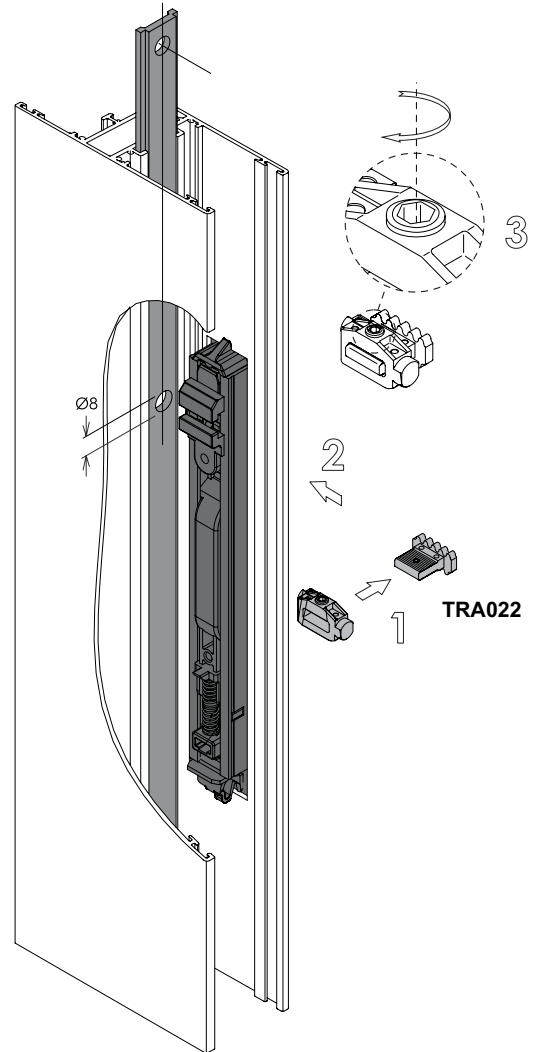
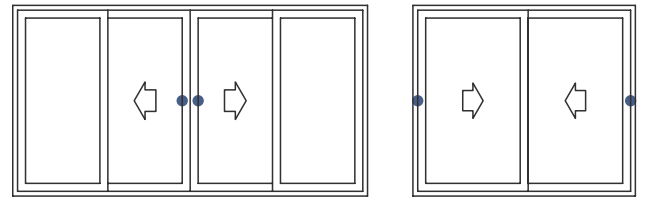

Aplicação

Posições dos Componentes

Porta Oscilo Paralela com Folha Fixa e Móvel

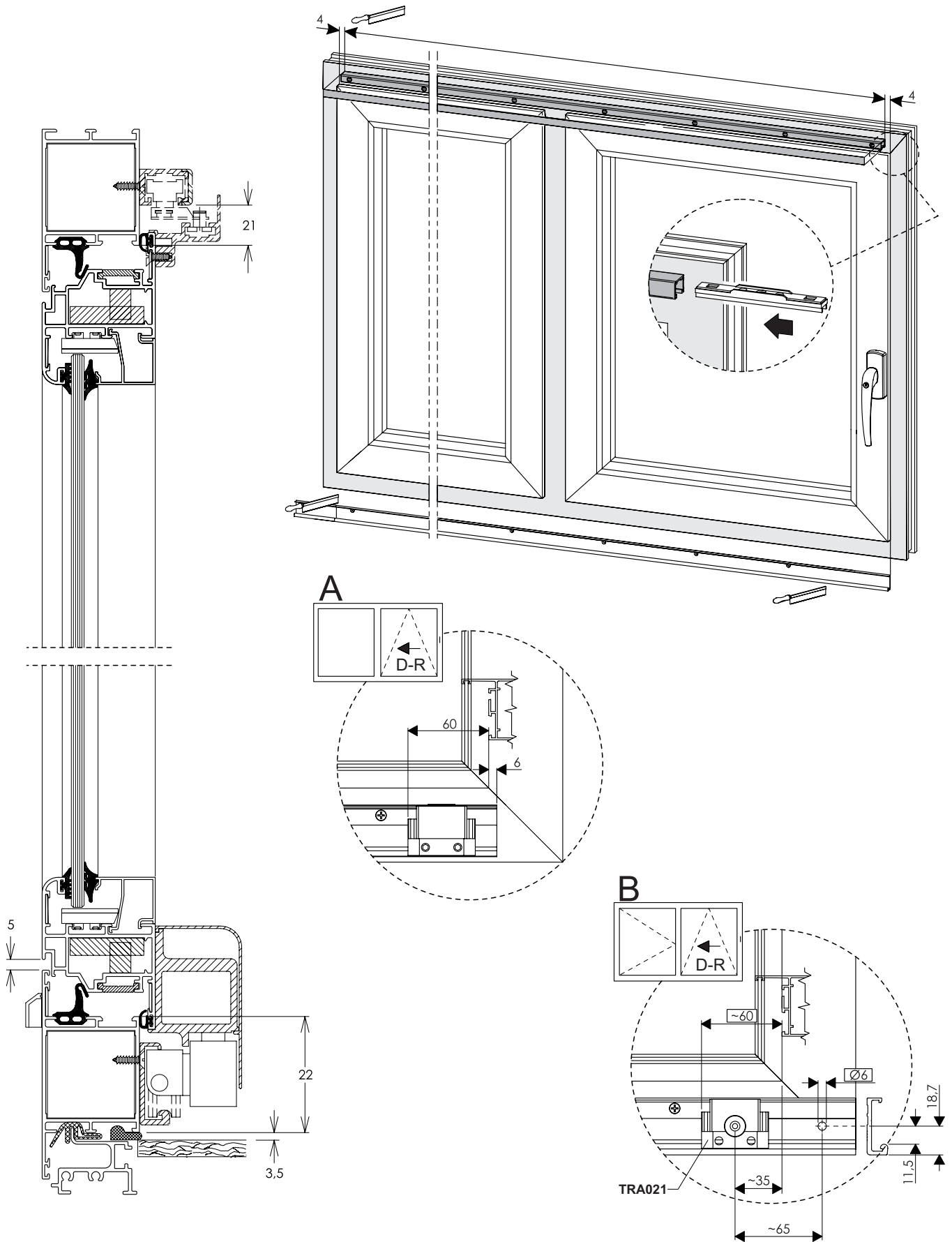

Unica Elevável

Detalhe de junção central

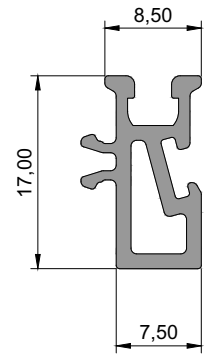
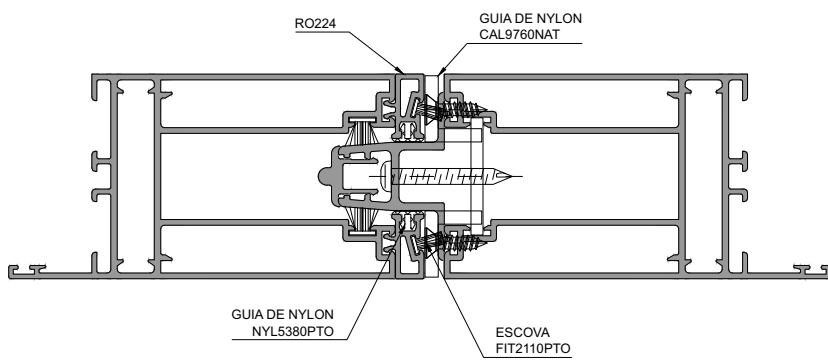

PERFIL - RO224

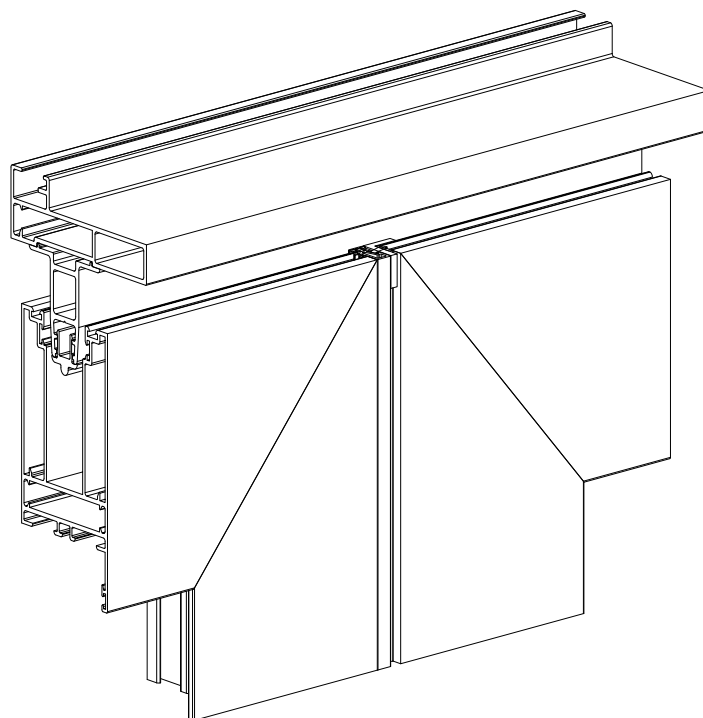
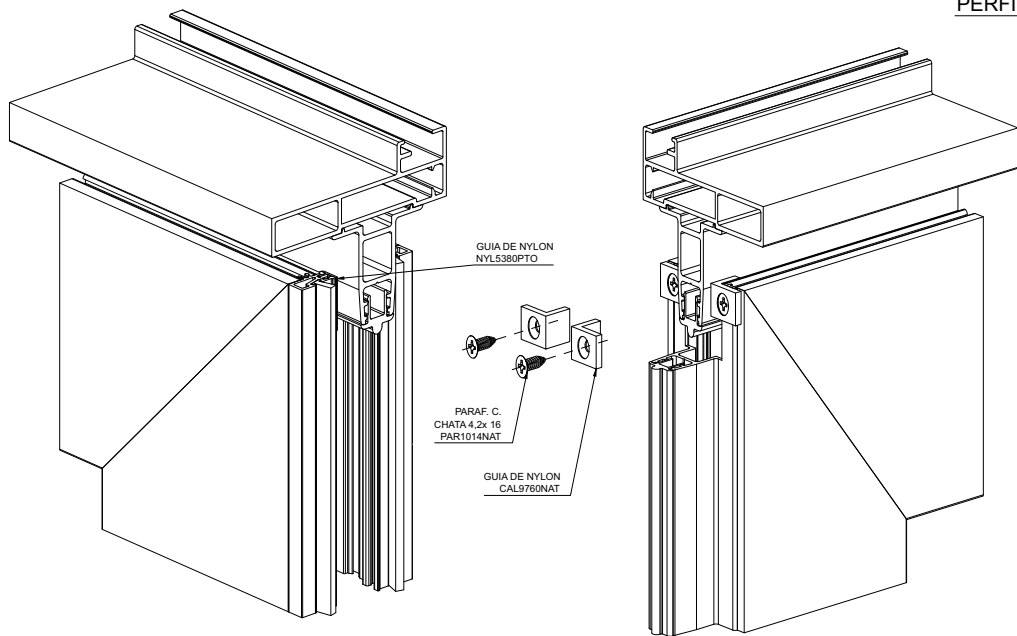

Vedação no trilho da Janela

Detalhe para vedação no trilho

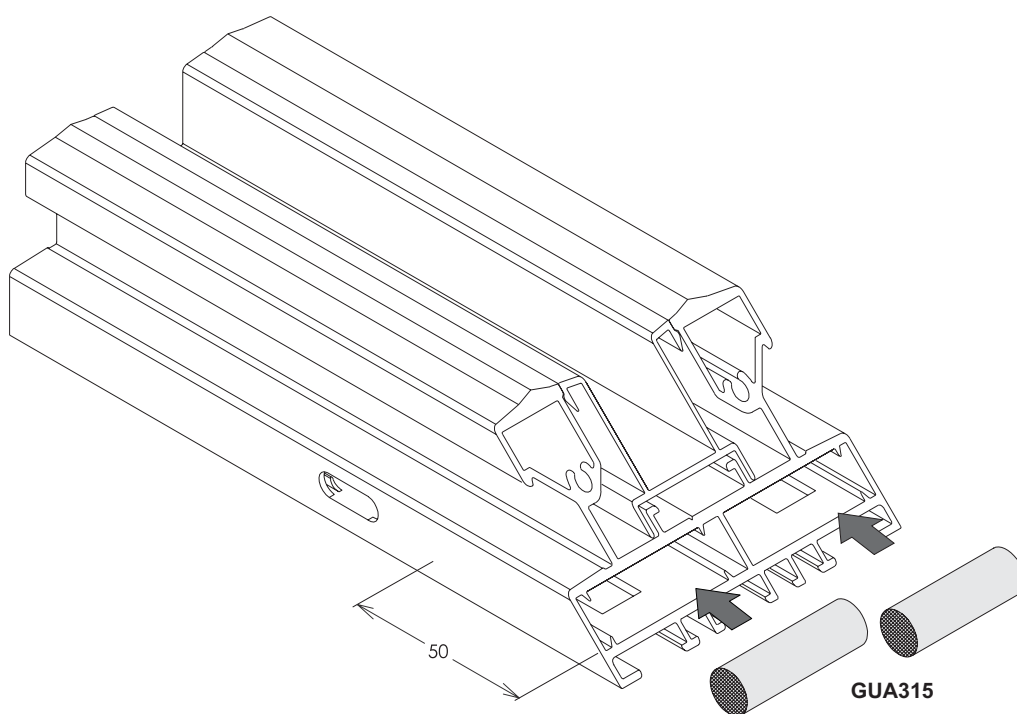
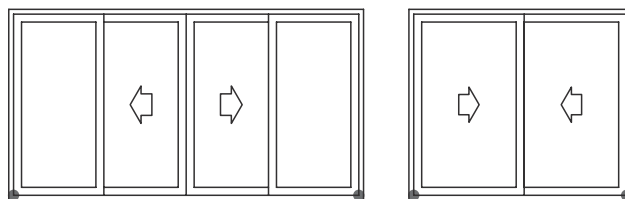

Encaixar a GUA315 no interior do trilho, e aplicar para evitar infiltração pelo rasgo da trava da conexão.

Posicionamento dos calços dos vidros

■ Calço de Apoio

■ Calço Periférico

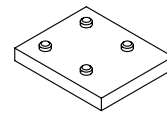
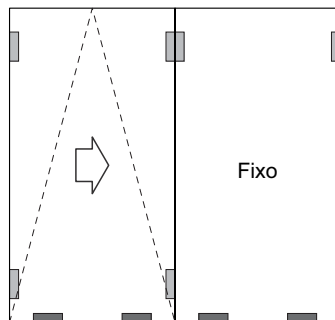
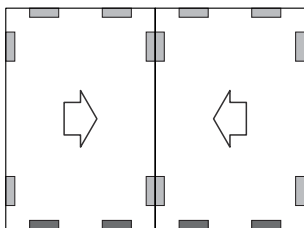
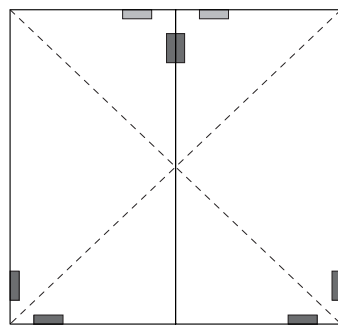
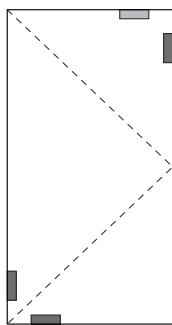
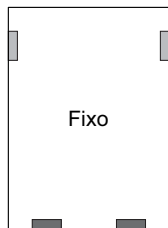
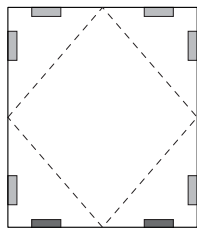
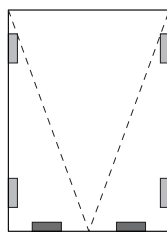
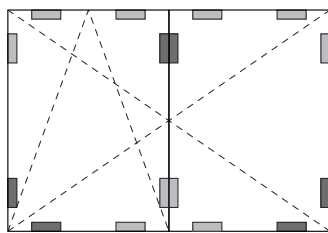
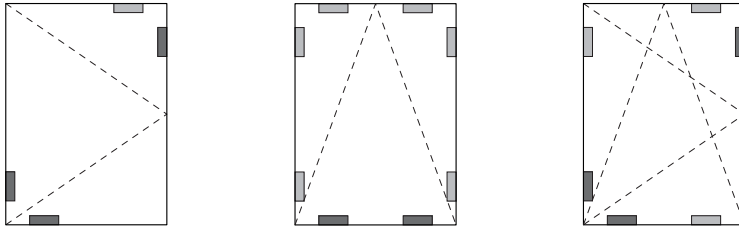

NYL486
Calço do Vidro - 2mm
Nylon Preto

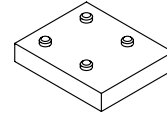

NYL487
Calço do Vidro - 3mm
Nylon Preto

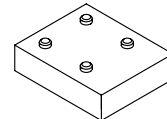

NYL488
Calço do Vidro - 4mm
Nylon Preto

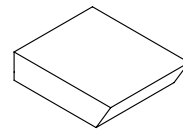



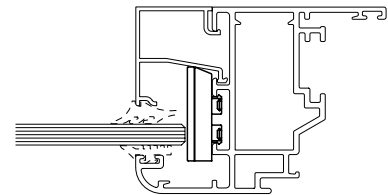

NYL485
Calço do Vidro - 5mm
Nylon Preto

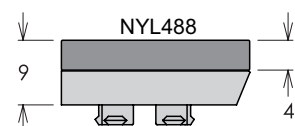
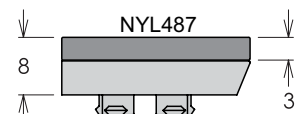
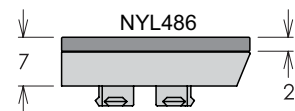
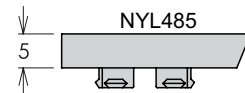





Aplicação

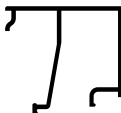
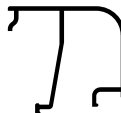
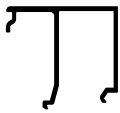
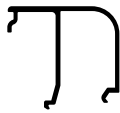
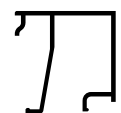
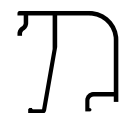
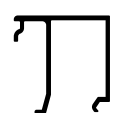
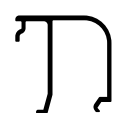
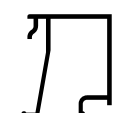
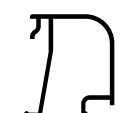
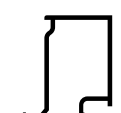
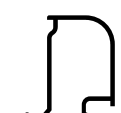
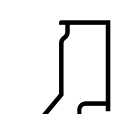
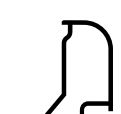

Alternativas construtivas - Guarnições para vidro

Guarnição Externa	Guarnição Interna
 GUA413 A = 3mm	 GUA414 B = 5mm
 GUA411 C = 5mm	 GUA412 D = 6mm

Tipologia/Espessura de Vidro			Guarnição	Baguetes			
Oscilo Batente, Maxim-ar, Giro, Tombar, Paralela, Reversível e Articulada	Linha Correr	Linha Elevável		Geral	Folhas Fixas		
4	- X -	12	B + D				
5	- X -	13	B + C				
6	- X -	14	A + D				
7	- X -	15	A + C				
8	4	16	B + D				
9	5	17	B + C				
10	6	18	A + D				
11	7	19	A + C				
12	8	20	B + D				
13	9	21	B + C				
14	10	22	A + D				
15	11	23	A + C				
16	12	24	B + D				
17	13	25	B + C				
18	14	26	A + D				
19	15	27	A + C				
20	16	28	B + D				
21	17	29	B + C				
22	18	30	A + D				
23	19	31	A + C				
30	26	38	B + D				
31	27	39	B + C				
32	28	40	A + D				
33	29	41	A + C				

Descrição	Pág.
JANELA OSCILO BATENTE 1 FOLHA	K-01
JANELA OSCILO BATENTE 1 FOLHA – THERMAL BREAK	K-02
JANELA OSCILO BATENTE 2 FOLHAS	K-03
JANELA OSCILO BATENTE 2 FOLHAS – THERMAL BREAK	K-04
JANELA DE GIRO 1 FOLHA	K-05
JANELA DE GIRO 1 FOLHA – THERMAL BREAK	K-06
JANELA DE GIRO 2 FOLHAS	K-07
JANELA DE GIRO 2 FOLHAS – THERMAL BREAK	K-08
JANELA DE GIRO 2 FOLHAS COM VENEZIANAS ORIENTÁVEIS	K-09
JANELA DE TOMBAR 1 FOLHA	K-10
JANELA DE TOMBAR 1 FOLHA – THERMAL BREAK	K-11
JANELA DE TOMBAR 2 FOLHAS	K-12
JANELA DE TOMBAR 2 FOLHAS – THERMAL BREAK	K-13
JANELA MAXIM-AR 1 FOLHA	K-14
JANELA MAXIM-AR 2 FOLHAS	K-15
JANELA MAXIM-AR 2 FOLHAS – THERMAL BREAK	K-16
JANELA DE CORRER 2 FOLHAS	K-17
JANELA DE CORRER 2 FOLHAS – MULTIPONTO – THERMAL BREAK	K-18
JANELA DE CORRER 4 FOLHAS – MULTIPONTO	K-19
JANELA DE CORRER 4 FOLHAS – MULTIPONTO – THERMAL BREAK	K-20
PORTA DE CORRER 2 FOLHAS COM MULTIPONTO	K-21
PORTA DE CORRER 4 FOLHAS COM MULTIPONTO	K-22
PORTA DE CORRER 2 FOLHAS COM REFORÇO E MULTIPONTO	K-23
PORTA DE CORRER 4 FOLHAS COM REFORÇO E MULTIPONTO	K-24
PORTA DE CORRER 2 FOLHAS COM FECHADURA E PUXADOR	K-25
PORTA DE CORRER 4 FOLHAS COM FECHADURA E PUXADO	K-26
PORTA DE CORRER 2 FOLHAS COM REFORÇO COM FECHADURA E PUXADOR	K-27
PORTA DE CORRER 4 FOLHAS, COM REFORÇO COM FECHADURA E PUXADOR	K-28
PORTA DE CORRER 4 FOLHAS COM REFORÇO E FECHADURA	K-29
PORTA DE CORRER 3 FOLHAS COM MULTIPONTO	K-30
PORTA DE GIRO 1 FOLHA – 40S	K-31
PORTA DE GIRO 1 FOLHA – 40TT – THERMAL BREAK	K-32
PORTA DE GIRO 2 FOLHAS – 40S	K-33
PORTA DE GIRO 2 FOLHAS – 40TT – THERMAL BREAK	K-34
PORTA ELEVÁVEL 2 FOLHAS	K-35
PORTA DE ELEVÁVEL 4 FOLHAS	K-36
JANELA DE CORRER 2 FOLHAS COM PERSIANA INTEGRADA	K-37
JANELA OSCILO BATENTE 2 FOLHAS COM PERSIANA INTEGRADA PROJETANTE	K-38
PORTA DE CORRER 2 FOLHAS COM PERSIANA INTEGRADA	K-39

ELEVAÇÃO VISTA EXTERNA

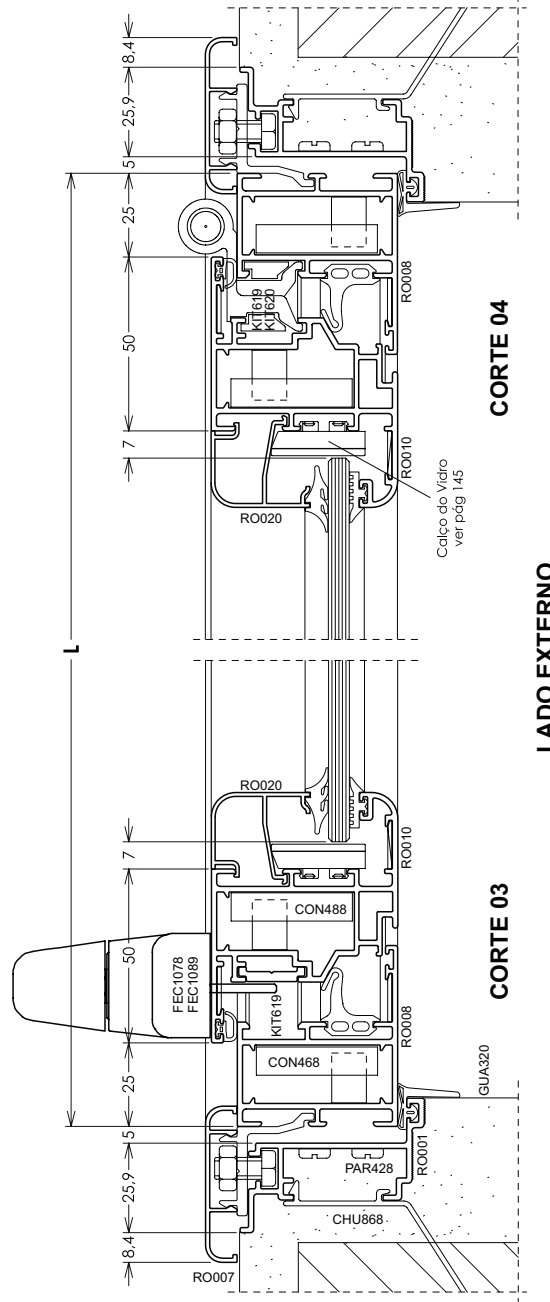
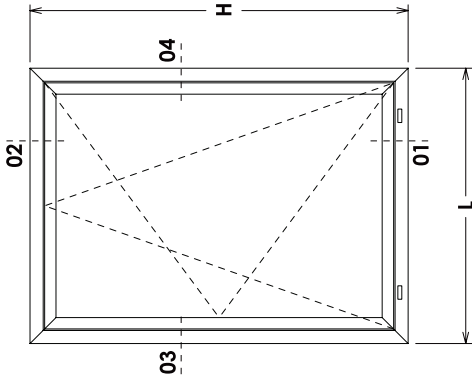

LADO EXTERNO

Janela Oscilo Batente 1 Folha

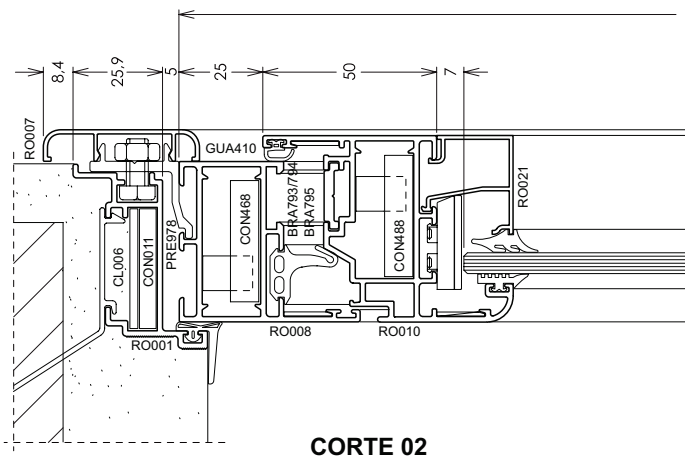

CORTE 02

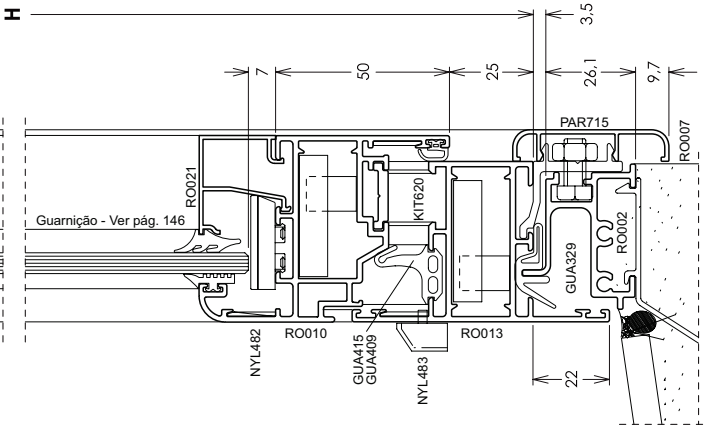

CORTE 01

LADO EXTERNO

ELEVAÇÃO VISTA EXTERNA

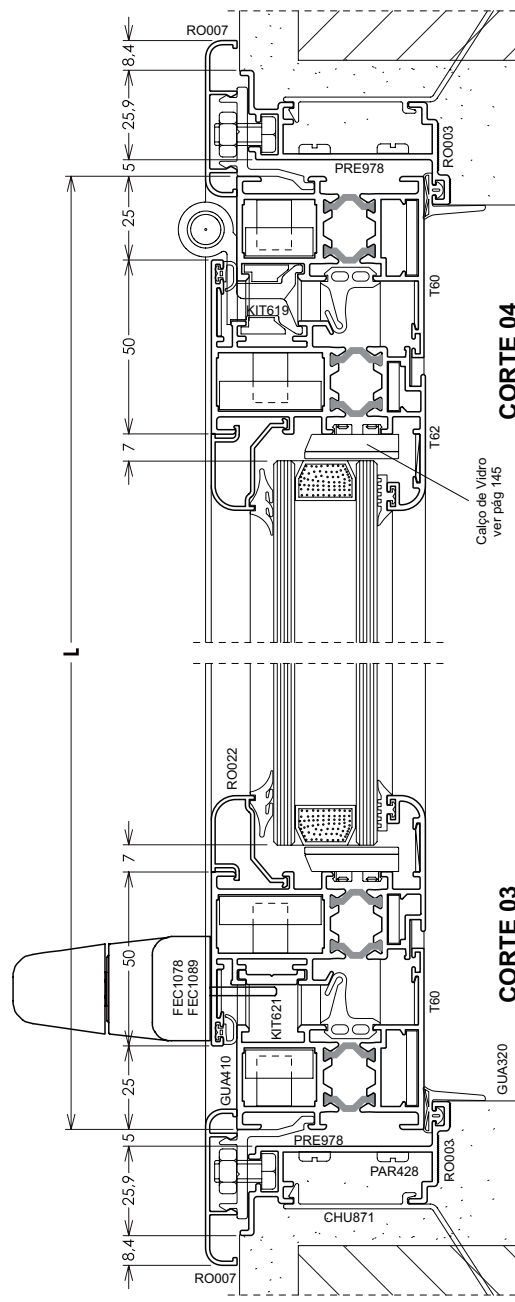
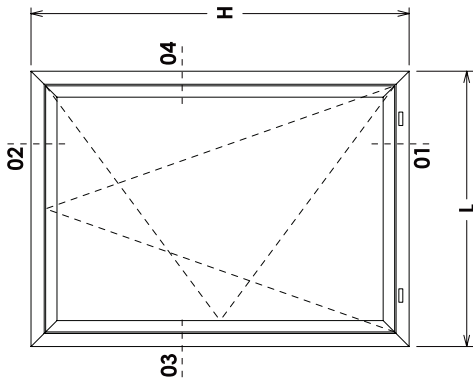

LADO EXTERNO

Janela Oscilo Batente 1 Folha Thermal Break

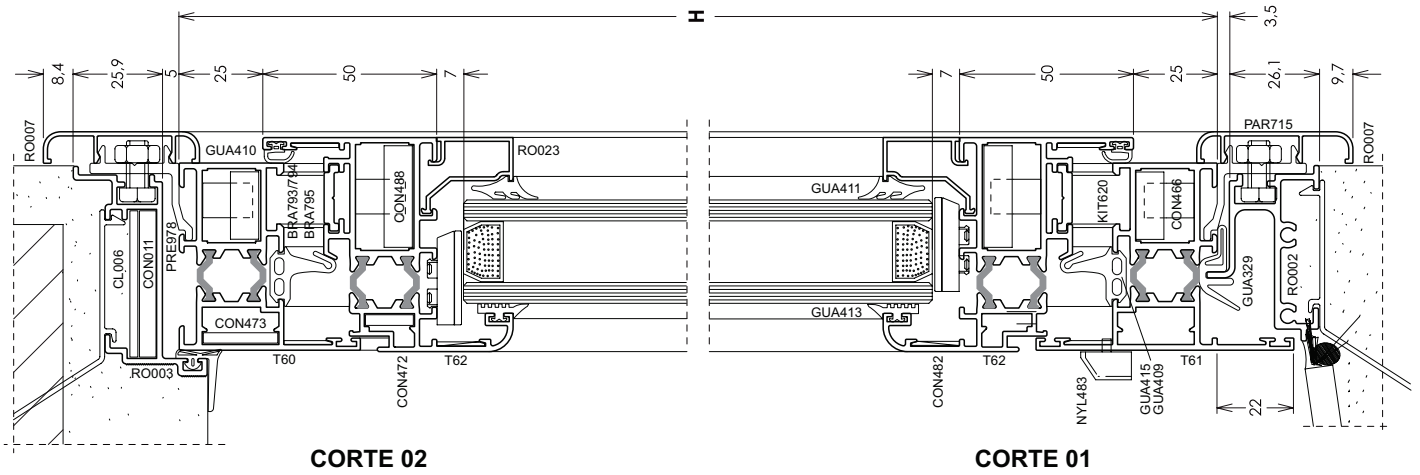

LADO EXTERNO

ELEVAÇÃO VISTA EXTERNA

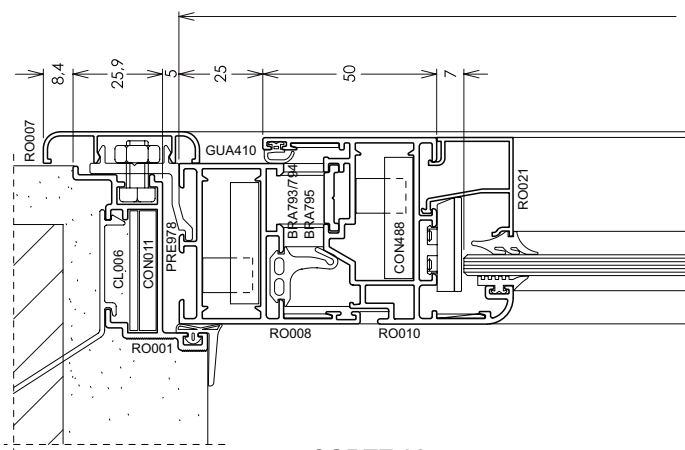
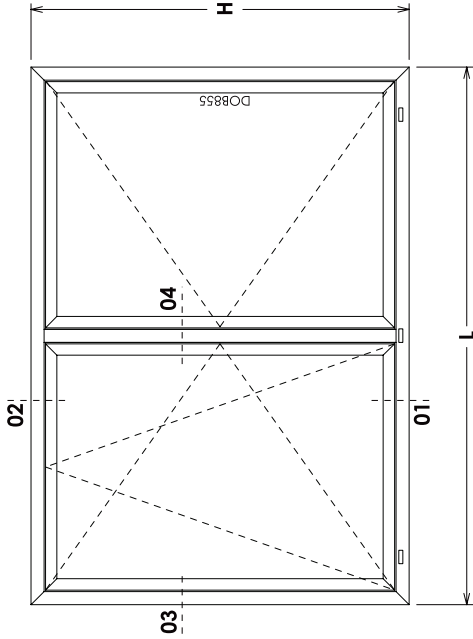

CORTE 02

LADO EXTERNO

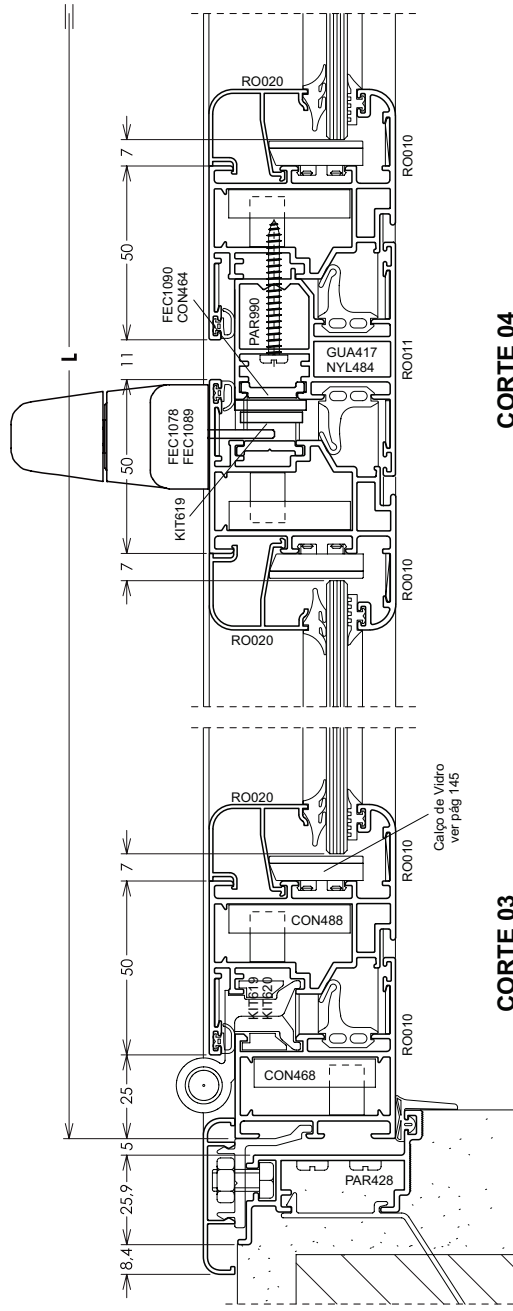

CORTE 04

LADO EXTERNO

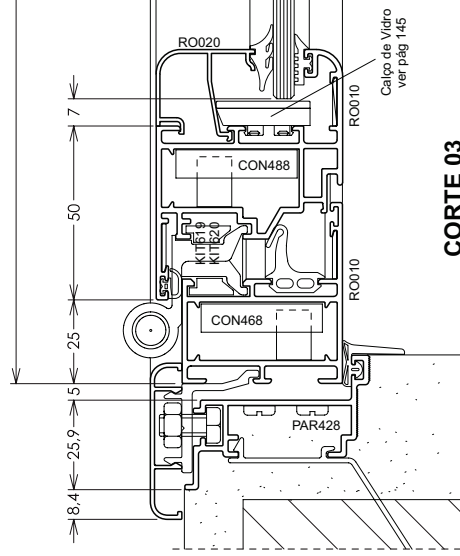

CORTE 03

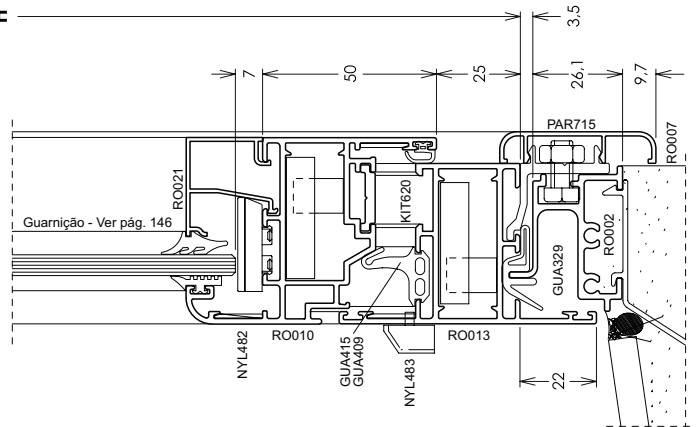

CORTE 01

Janela Oscilo Batente 2 Folhas

ELEVAÇÃO VISTA EXTERNA

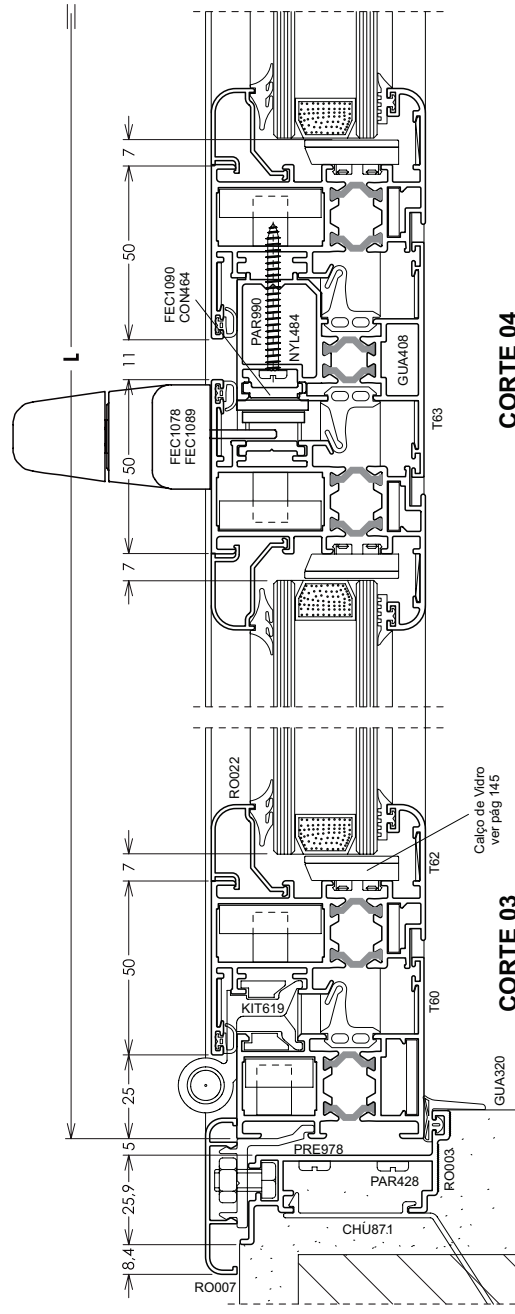
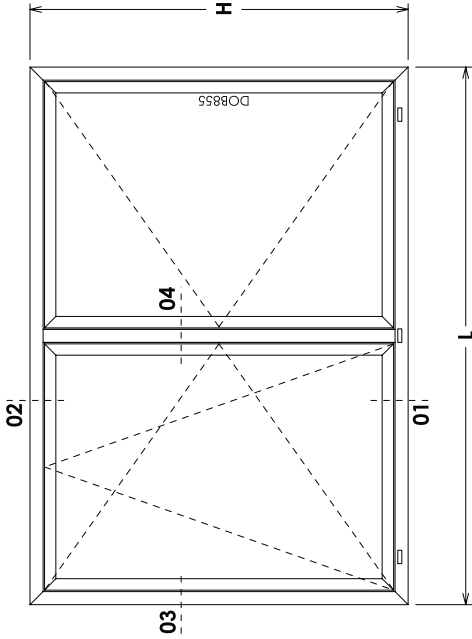

CORTE 04

LADO EXTERNO

CORTE 03

Janela Oscilo Batente 2 Folhas Thermal Break

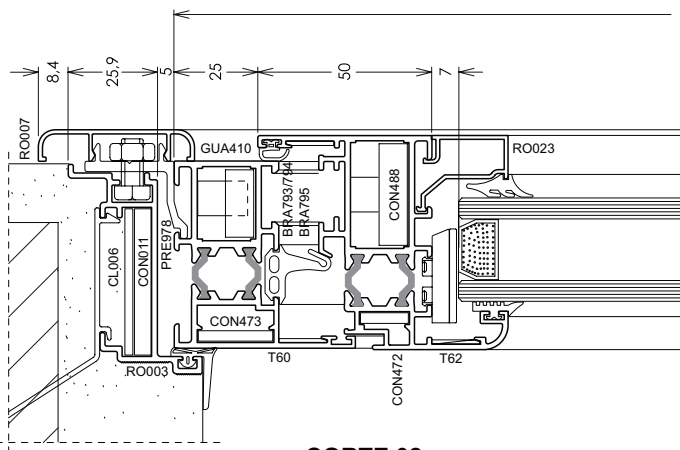

CORTE 02

LADO EXTERNO

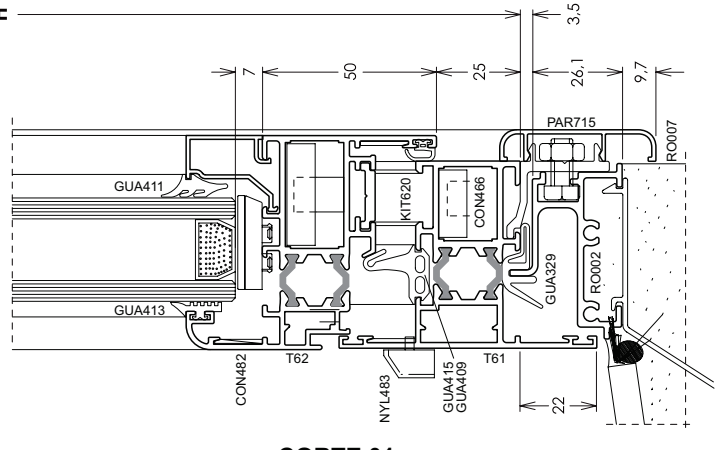

CORTE 01

ELEVAÇÃO VISTA EXTERNA

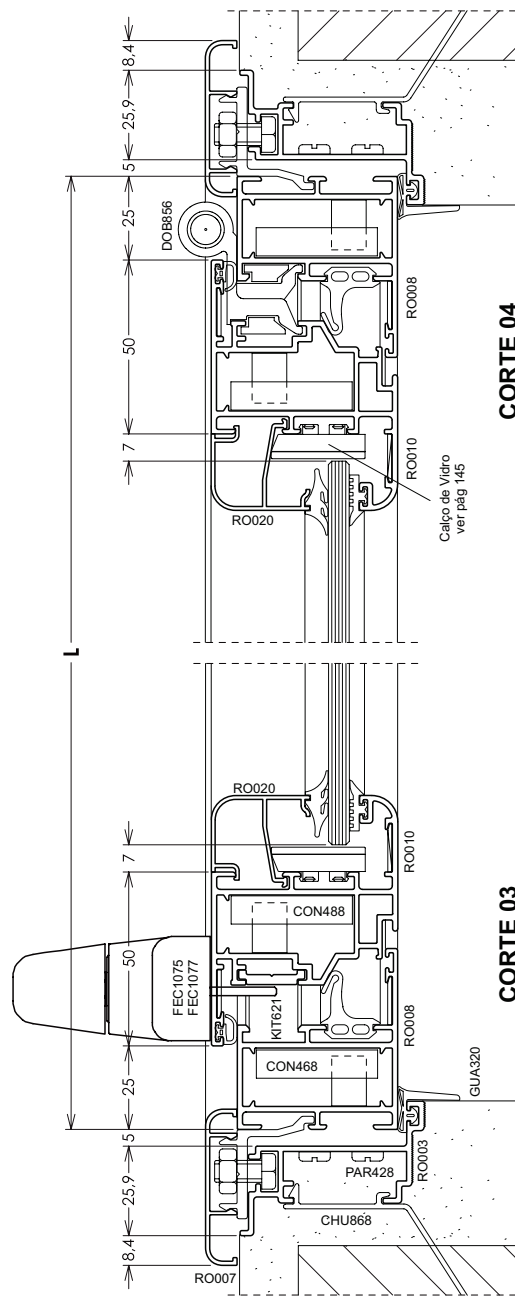
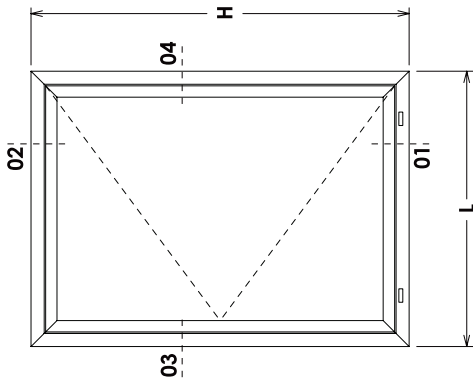

CORTE 04

CORTE 03

LADO EXTERNO

Janela De Giro 1 Folha

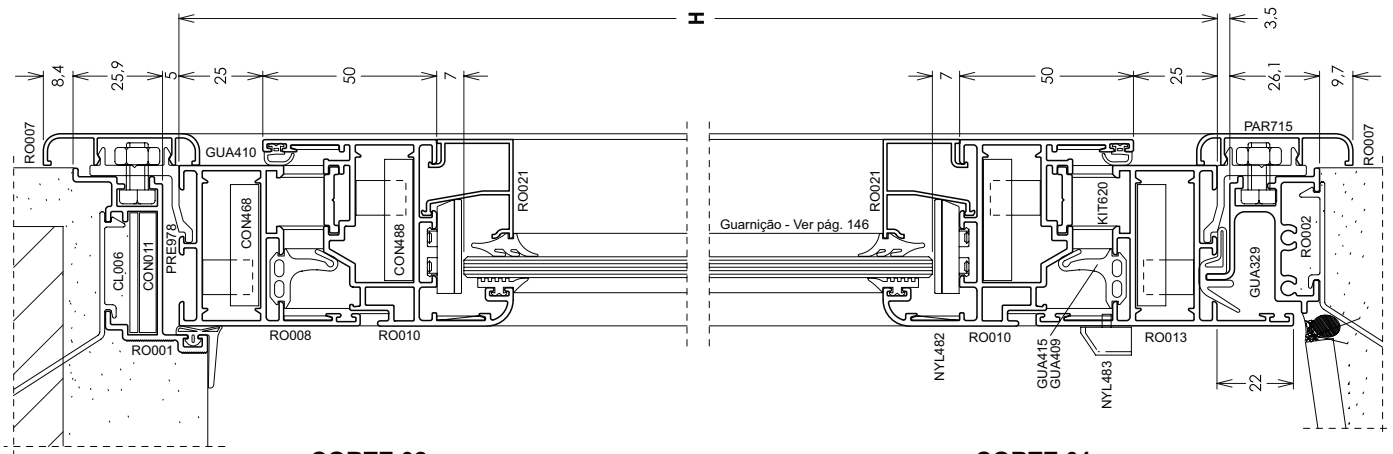

CORTE 02

CORTE 01

LADO EXTERNO

ELEVAÇÃO VISTA EXTERNA

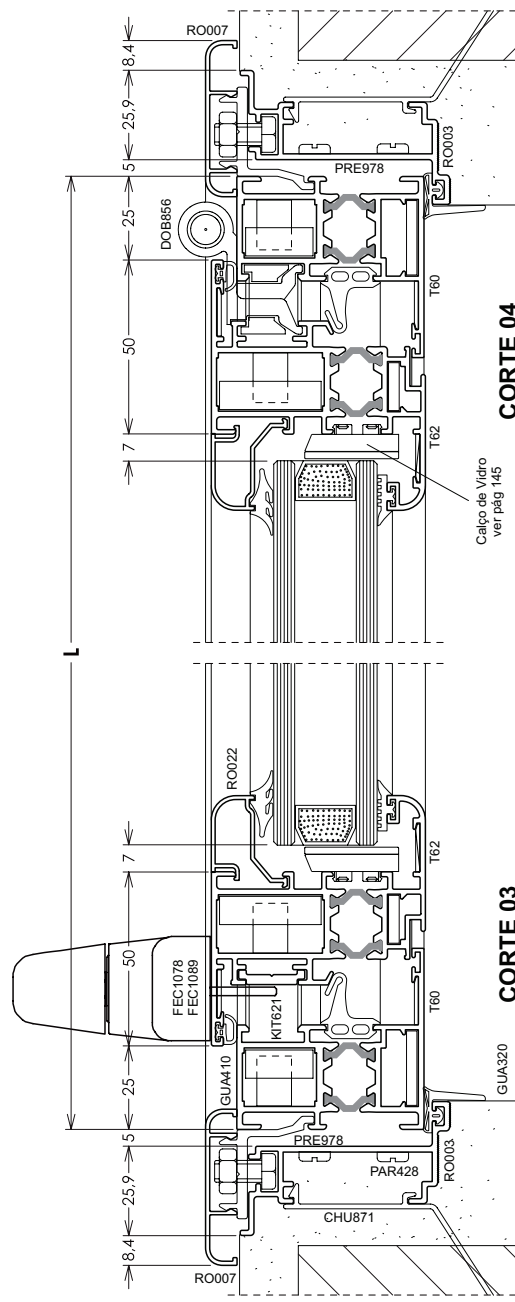
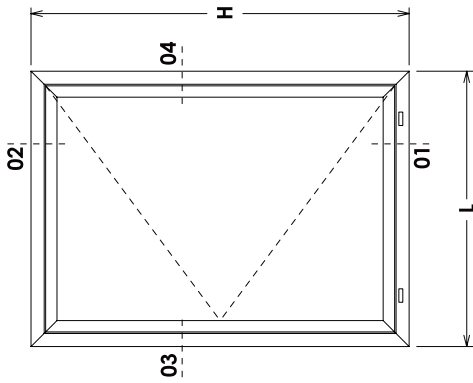

LADO EXTERNO

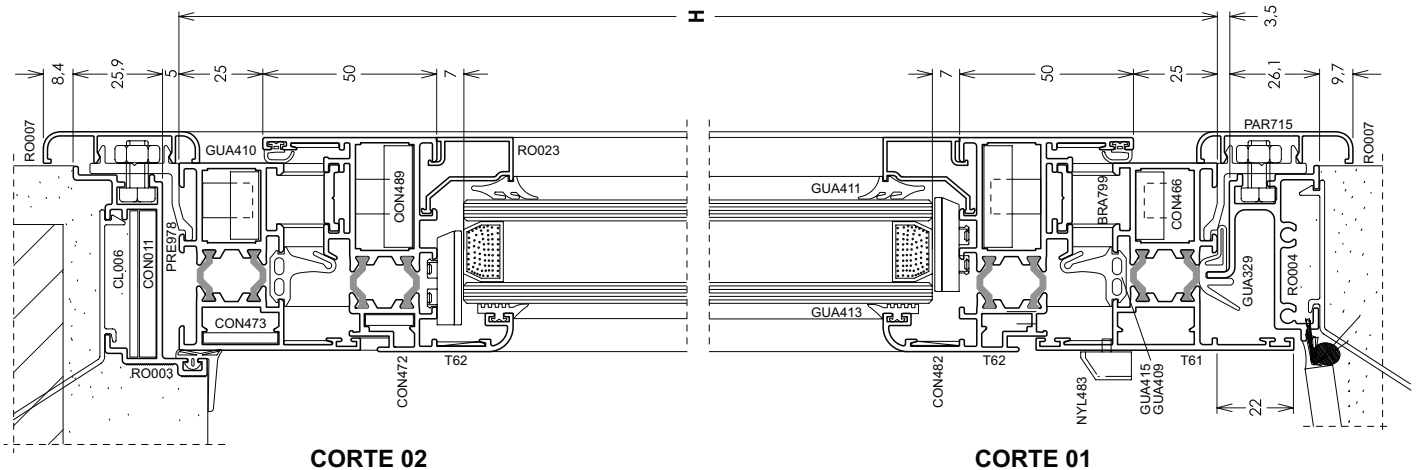

CORTE 02

CORTE 01

LADO EXTERNO

Janela De Giro 1 Folha Thermal Break

ELEVAÇÃO VISTA EXTERNA

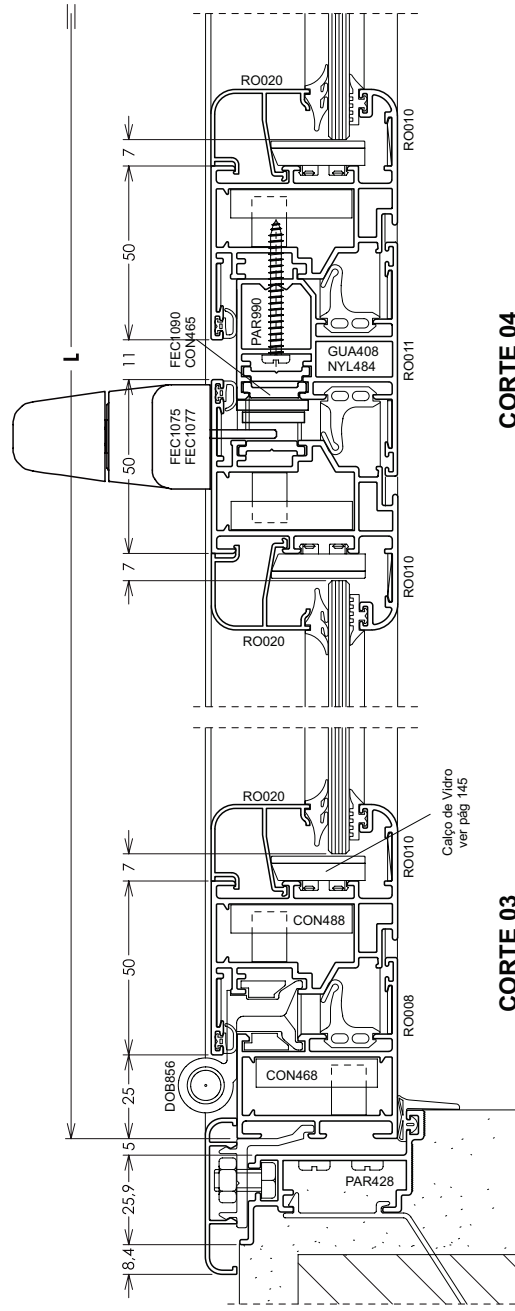
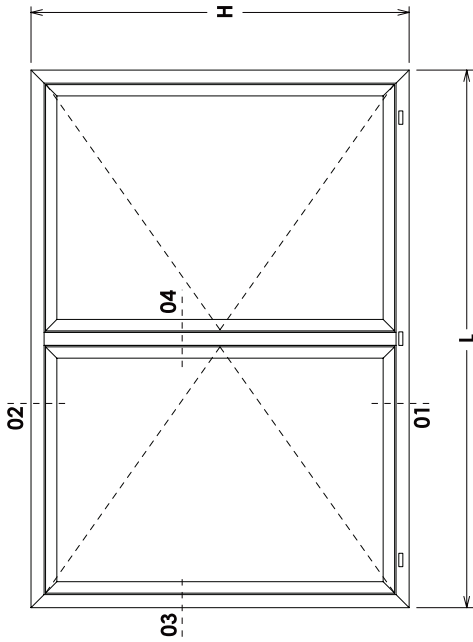

CORTE 04

CORTE 03

LADO EXTERNO

Janela De Giro 2 Folhas

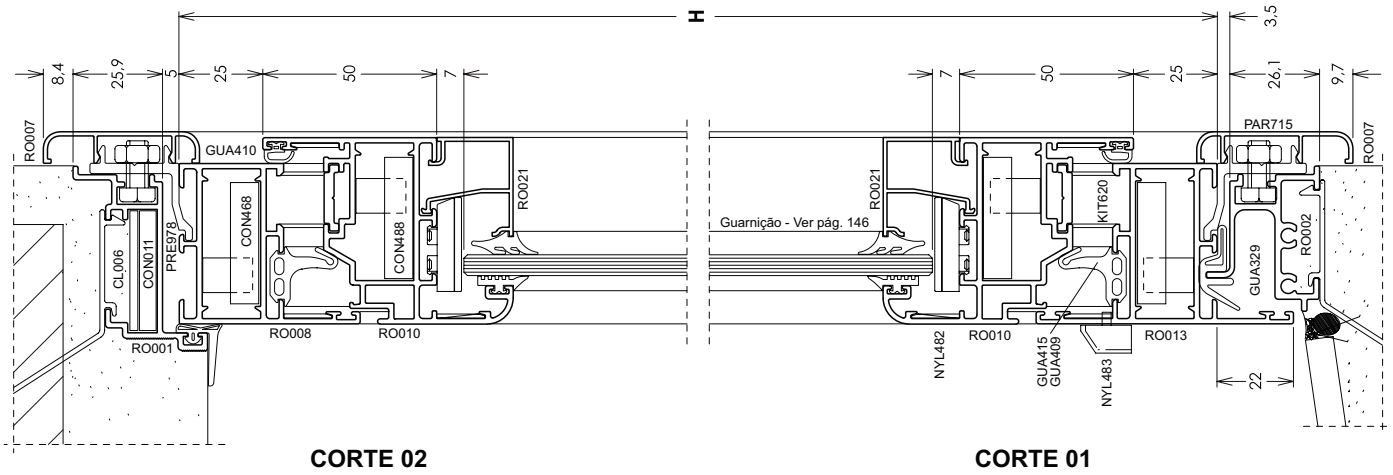

CORTE 02

CORTE 01

LADO EXTERNO

ELEVAÇÃO VISTA EXTERNA

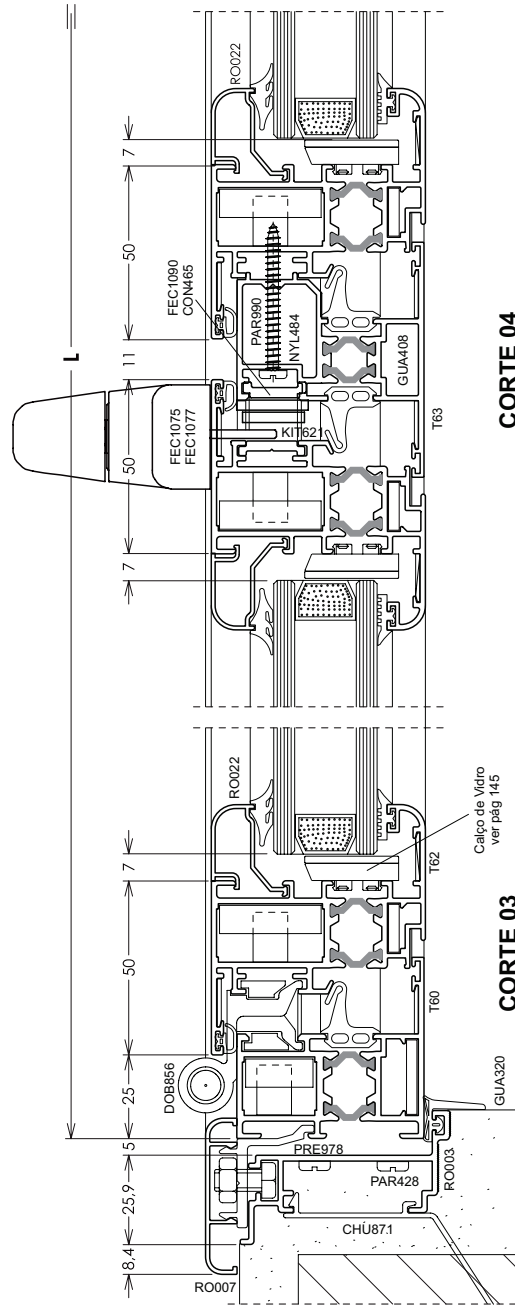
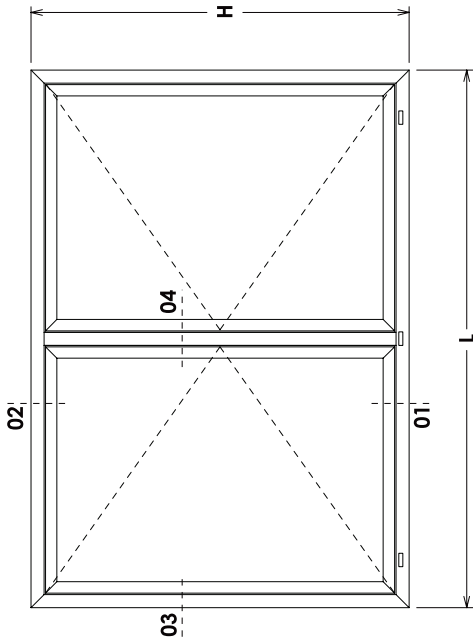

LADO EXTERNO

CORTE 04

CORTE 03

Janela De Giro 2 Folhas Thermal Break

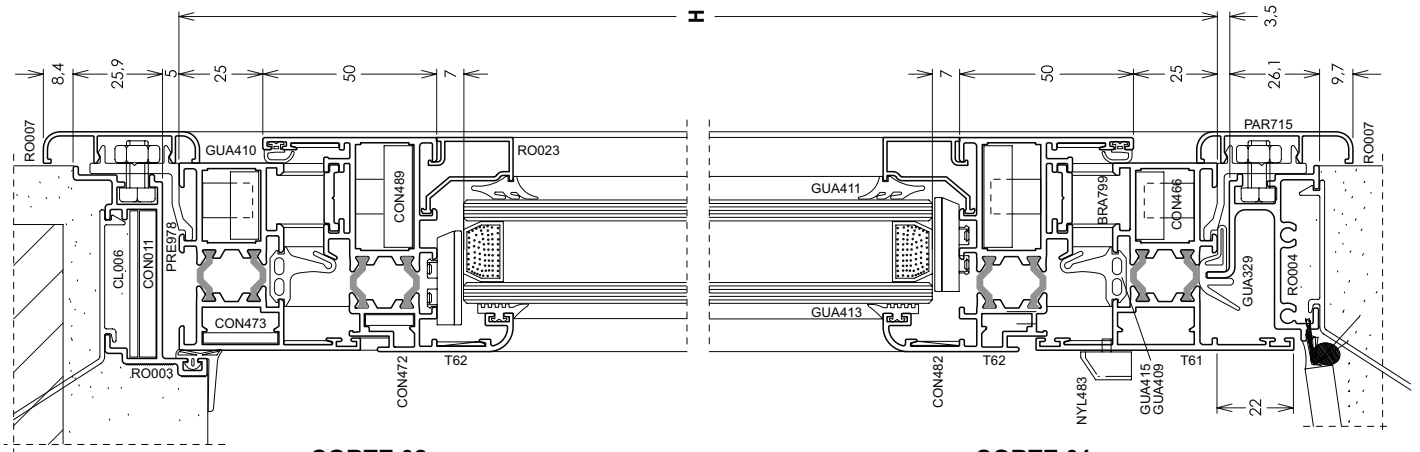

CORTE 02

CORTE 01

LADO EXTERNO

ELEVAÇÃO VISTA EXTERNA

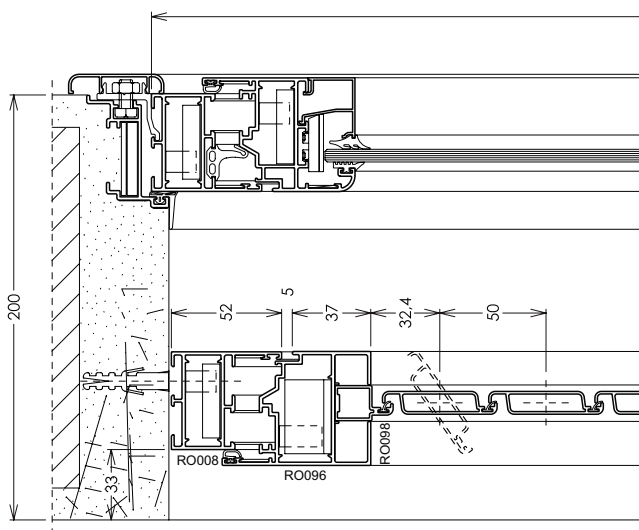
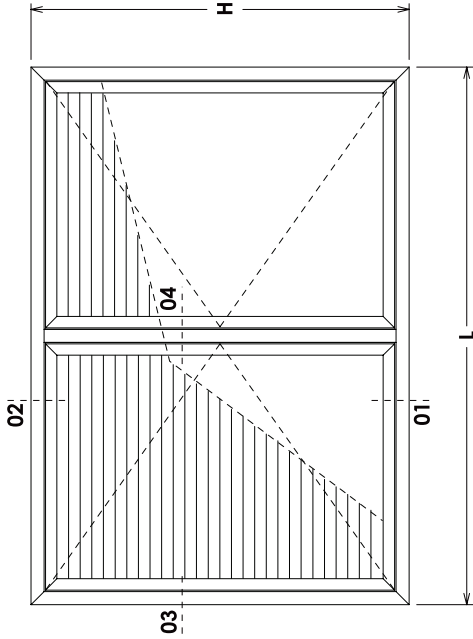

CORTE 02

LADO EXTERNO

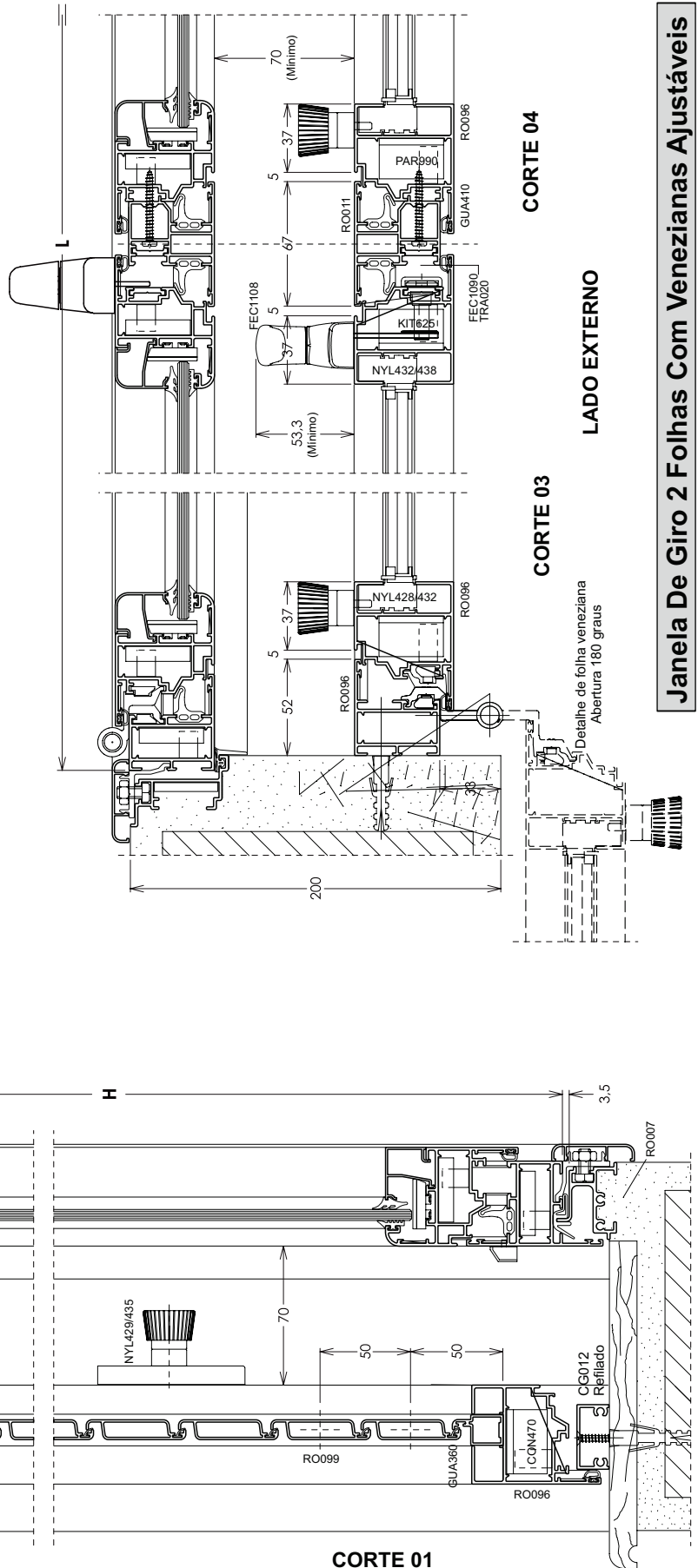

CORTE 04

CORTE 03

LADO EXTERNO

Janela De Giro 2 Folhas Com Venezianas Ajustáveis

ELEVAÇÃO VISTA EXTERNA

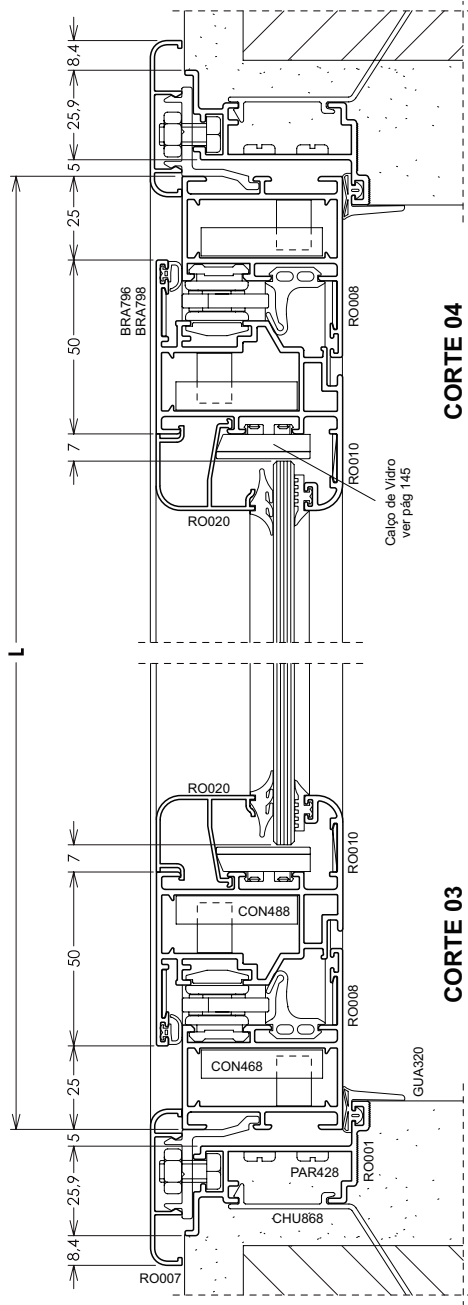
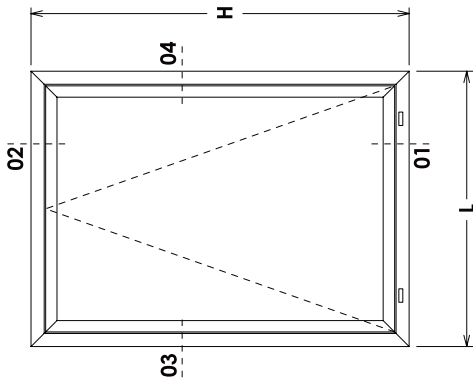

LADO EXTERNO

Janela De Bombas 1 Folha

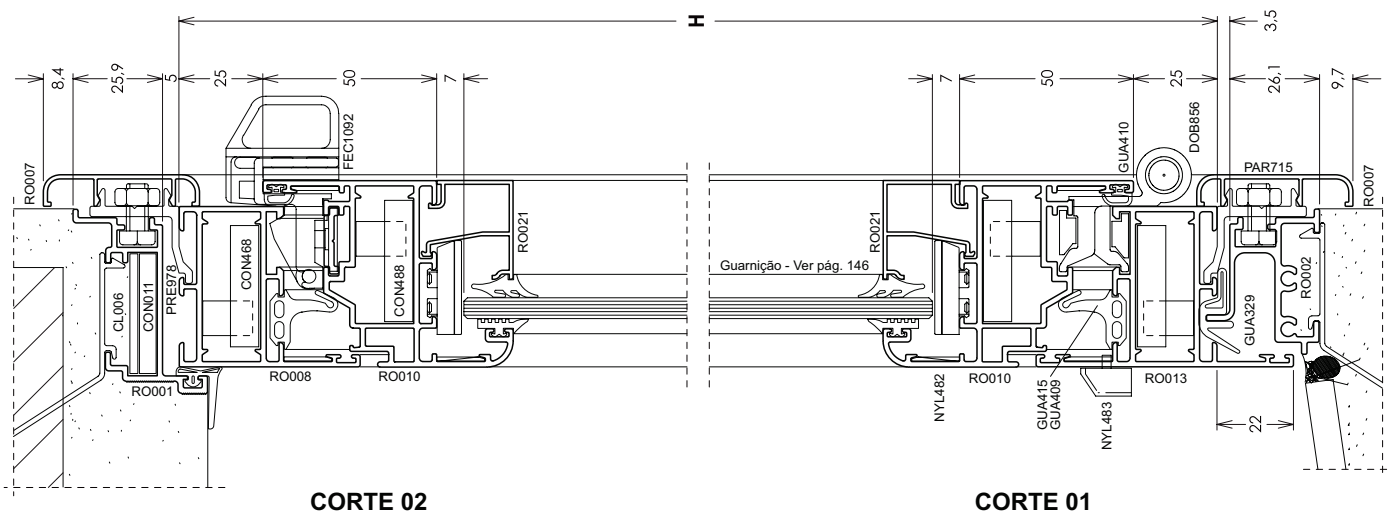

CORTE 02

CORTE 01

LADO EXTERNO

ELEVAÇÃO VISTA EXTERNA

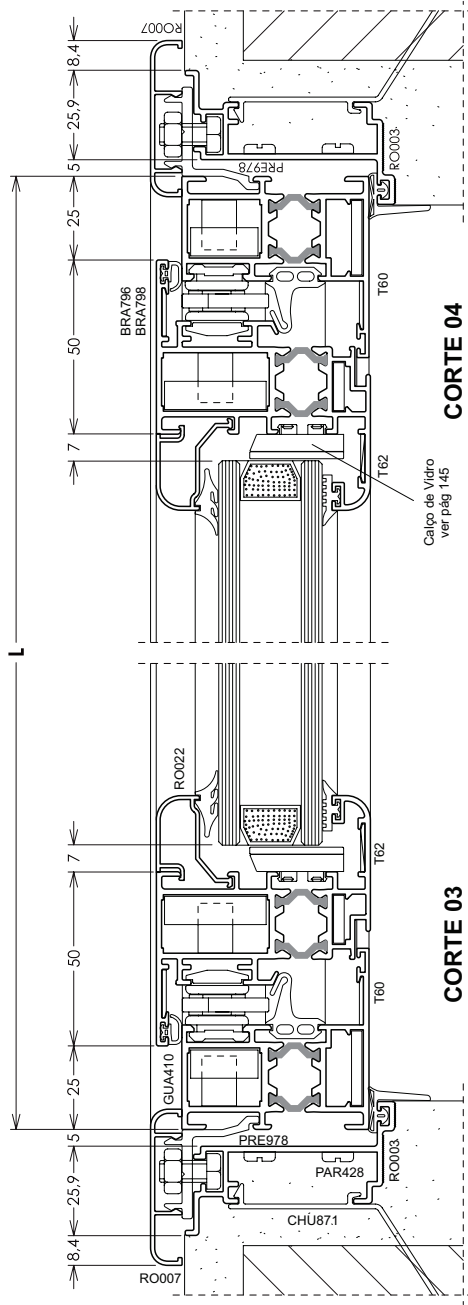
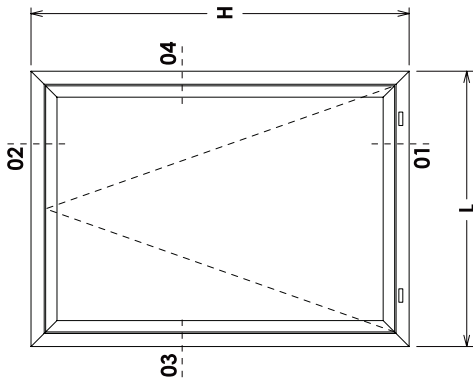

LADO EXTERNO

Janela De Tombar 1 Folha Thermal Break

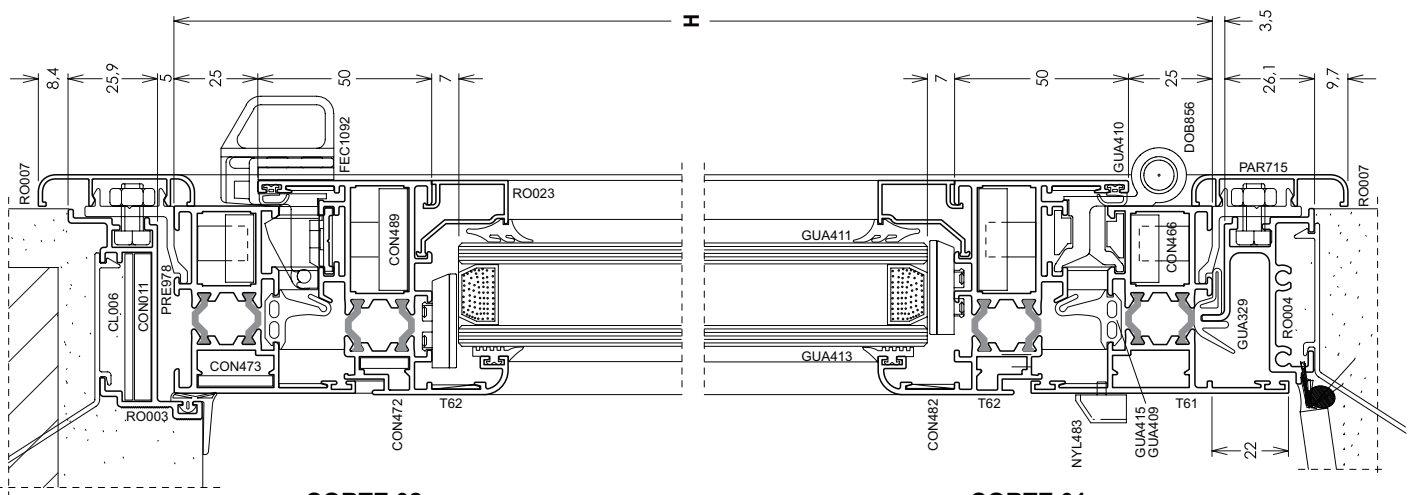

CORTE 02

CORTE 01

LADO EXTERNO

ELEVAÇÃO VISTA EXTERNA

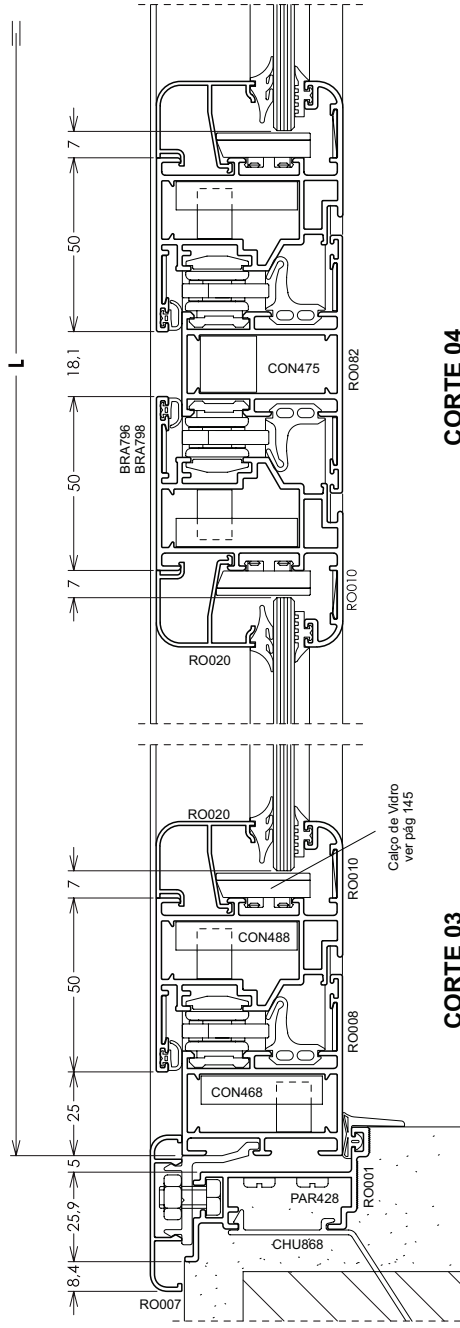
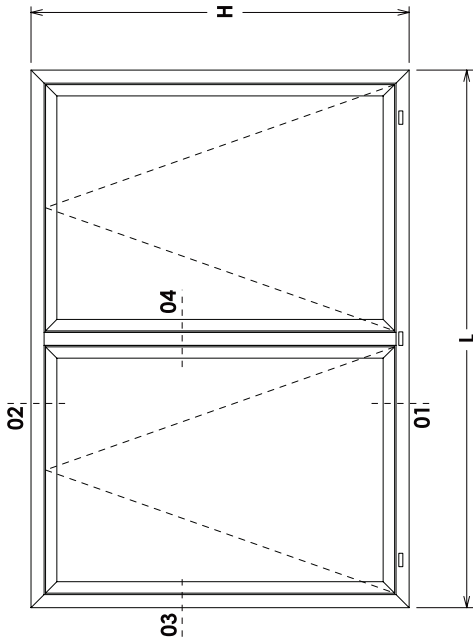

LADO EXTERNO

Janela De Bombas 2 Folhas

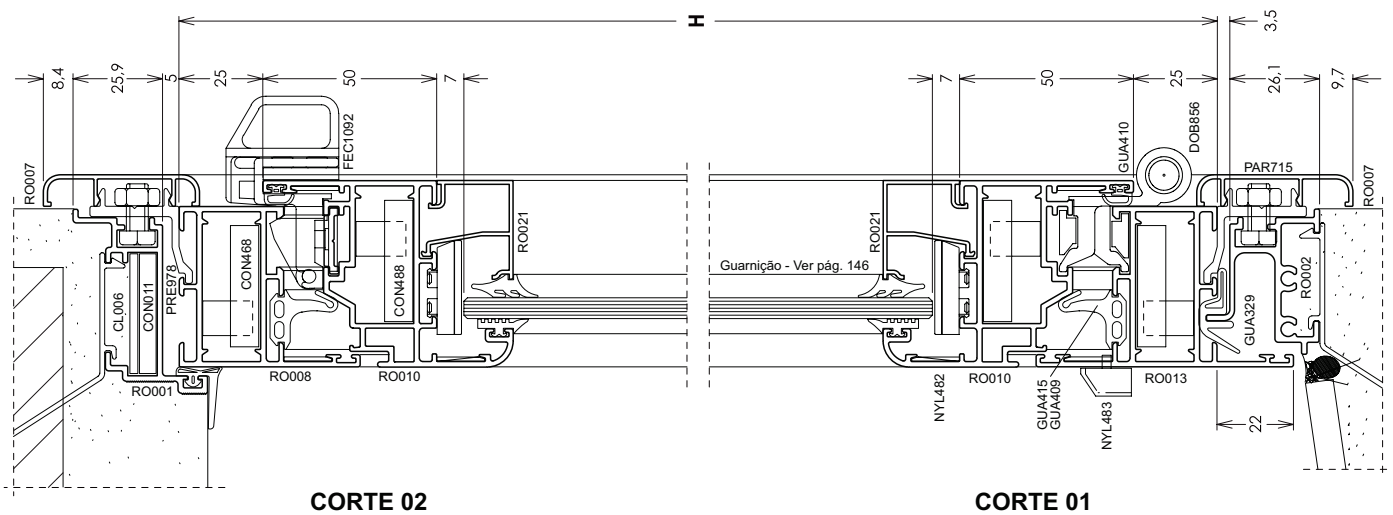

LADO EXTERNO

ELEVAÇÃO VISTA EXTERNA

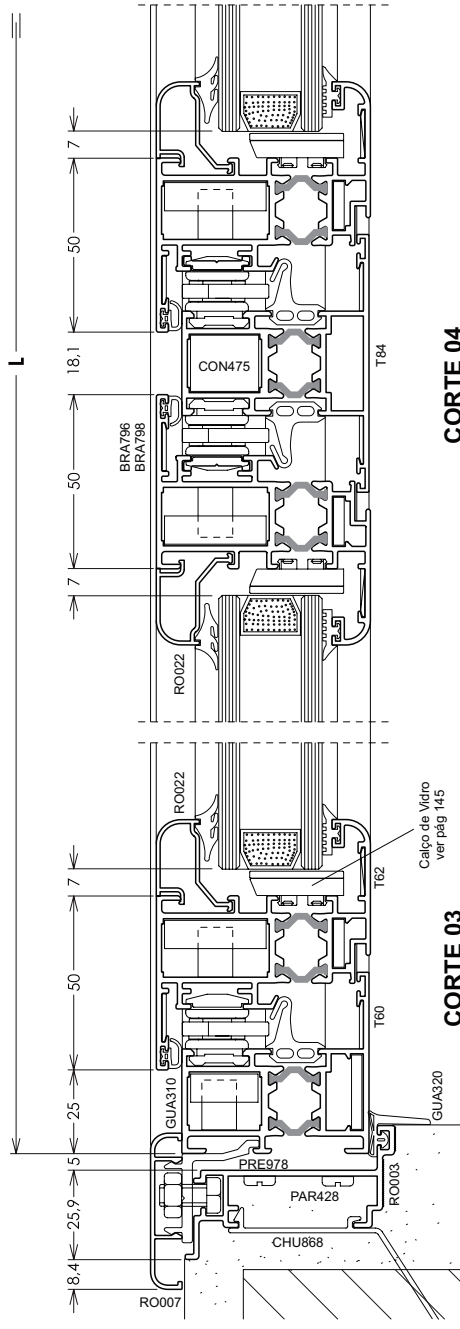
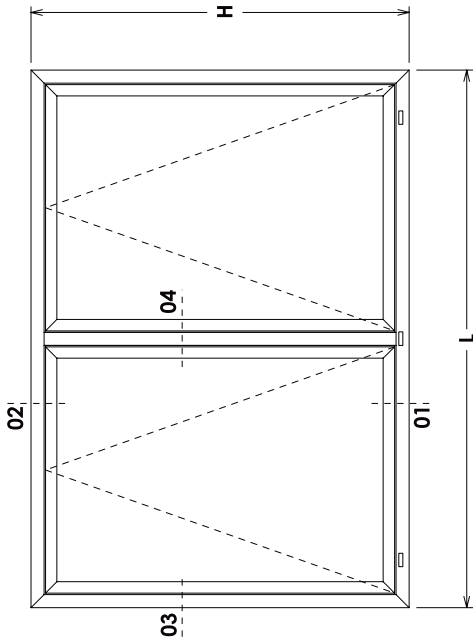

LADO EXTERNO

Janela De Tombar 2 Folhas Thermal Break

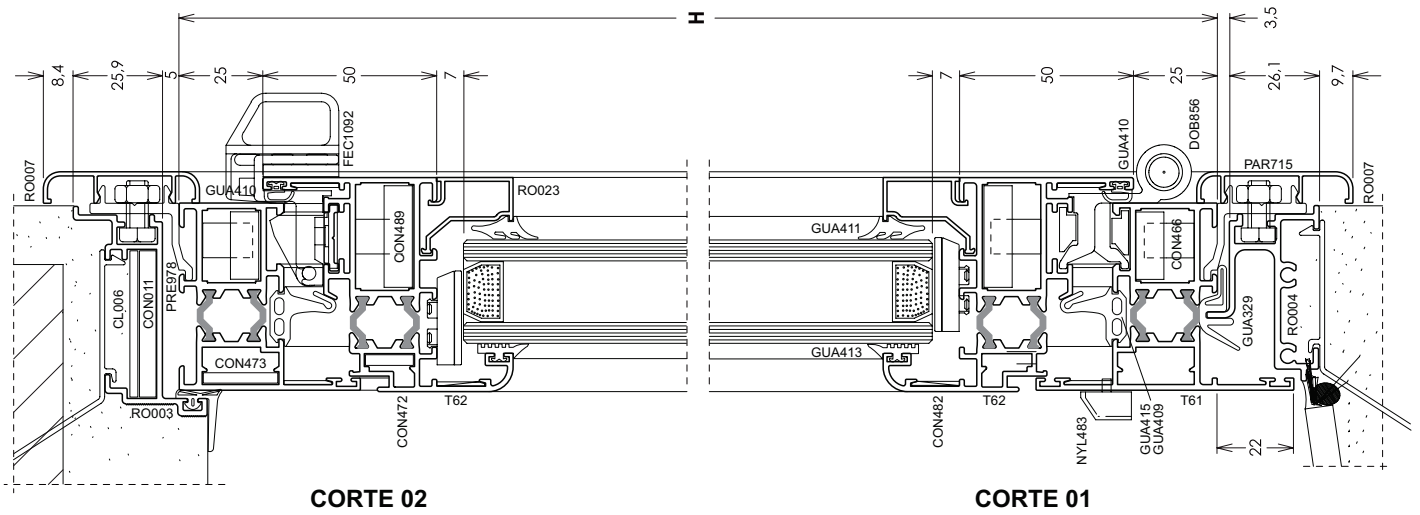

LADO EXTERNO

ELEVAÇÃO VISTA EXTERNA

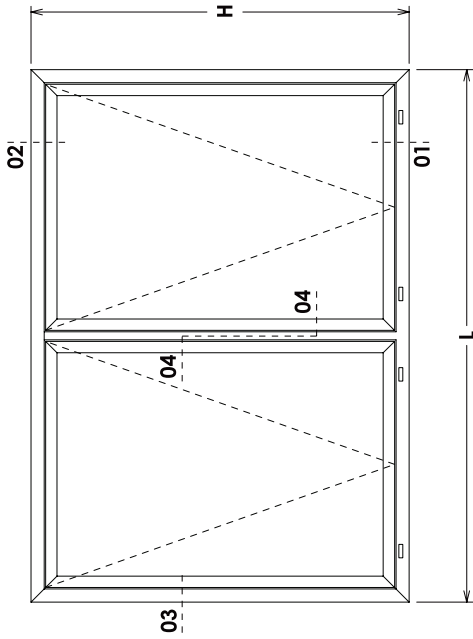

Utilizar limitador de abertura para folhas c/ altura acima de 1200 mm.

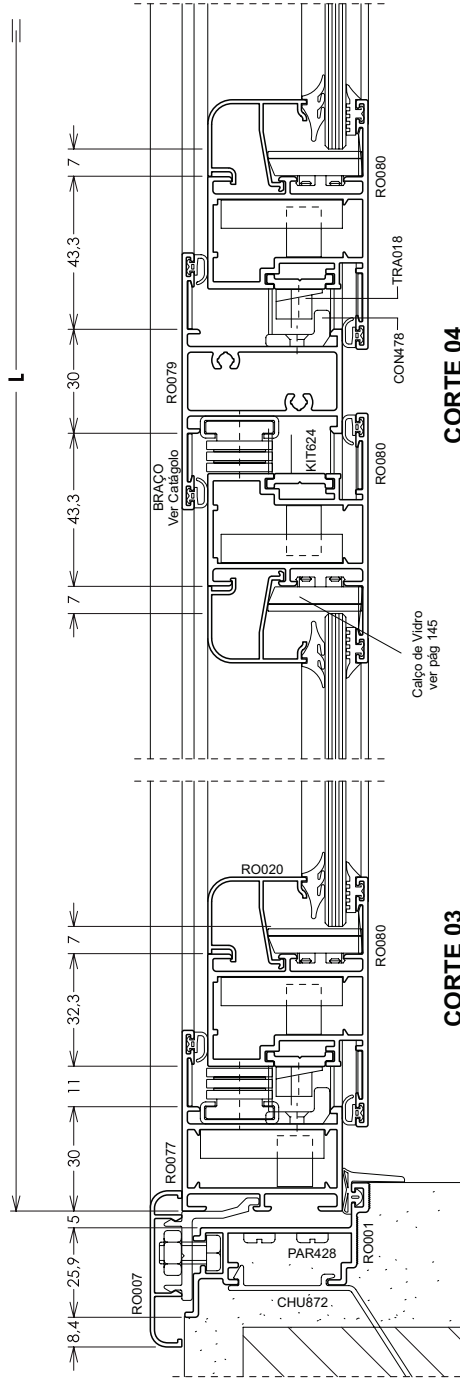

LADO EXTERNO

CORTE 03

CORTE 04

Caço de Vidro ver pág 145

Janela Maxim-ar 2 Folhas

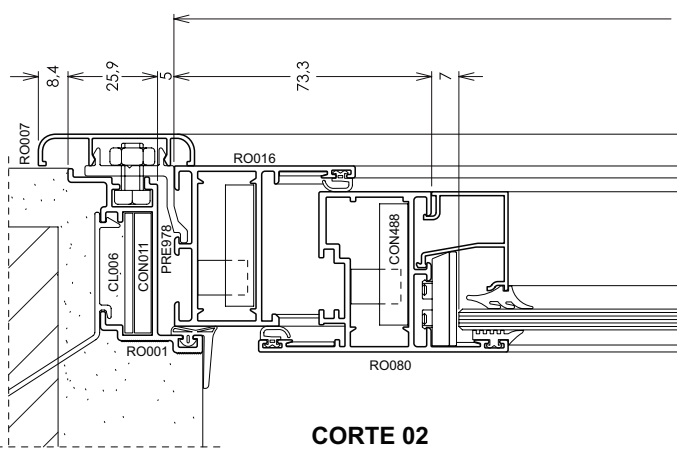

CORTE 02

LADO EXTERNO

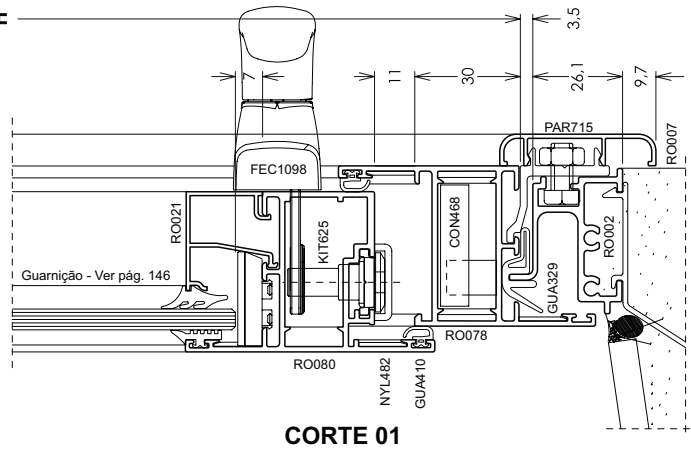

CORTE 01

ELEVAÇÃO VISTA EXTERNA

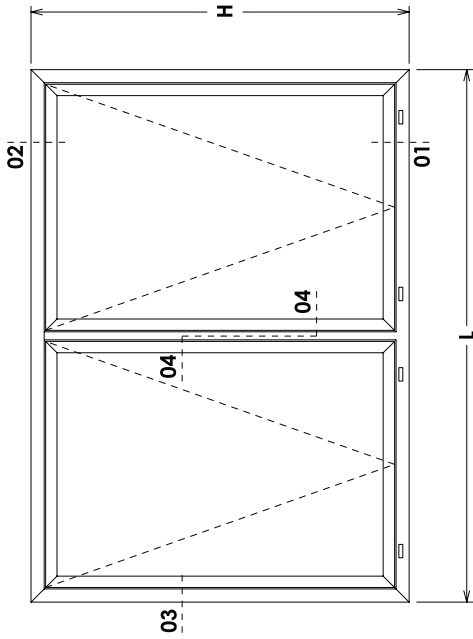

Utilizar limitador de abertura para folhas c/ altura acima de 1200 mm.

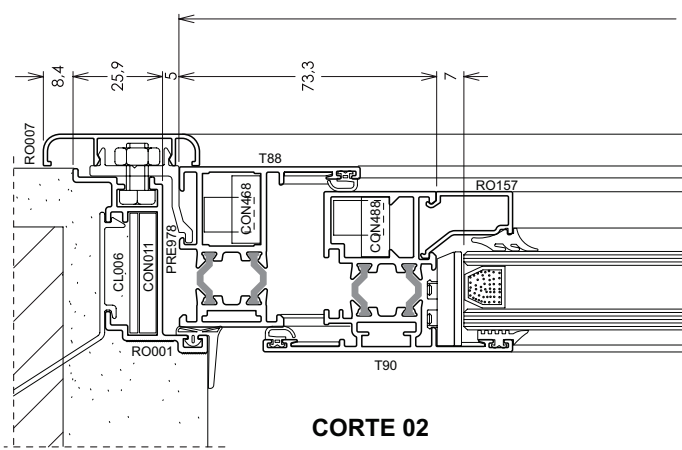

CORTE 02

LADO EXTERNO

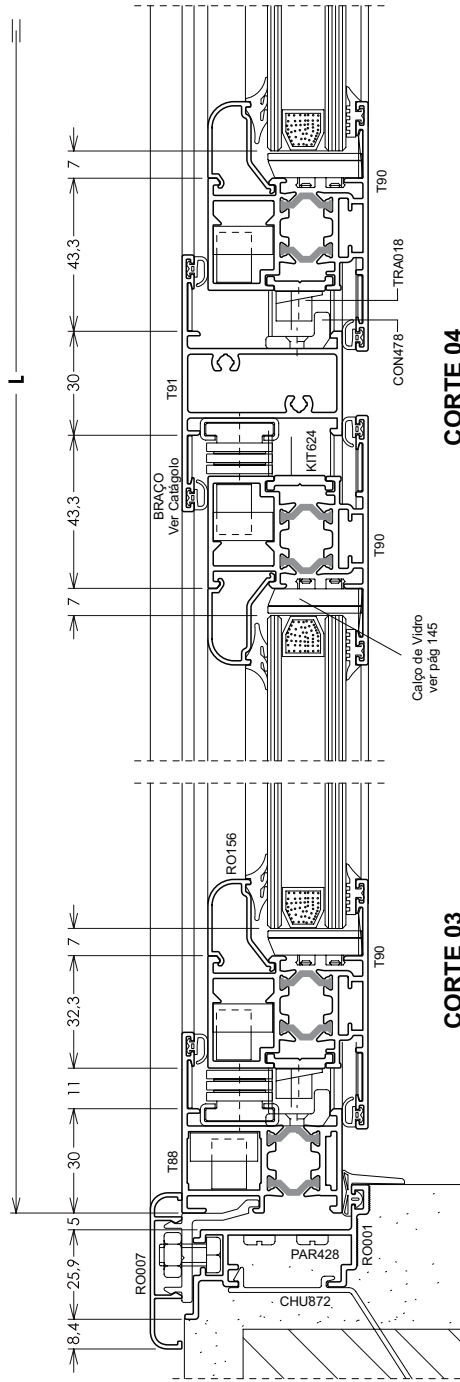

CORTE 04

CORTE 03

LADO EXTERNO

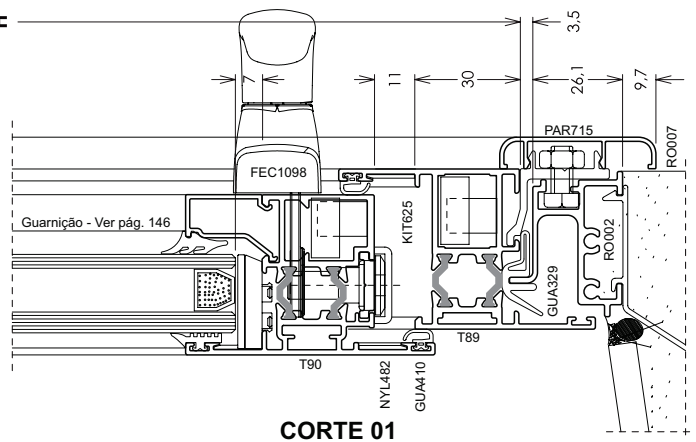

CORTE 01

Janela Maxim-ar 2 Folhas Thermal Break

ELEVAÇÃO VISTA EXTERNA

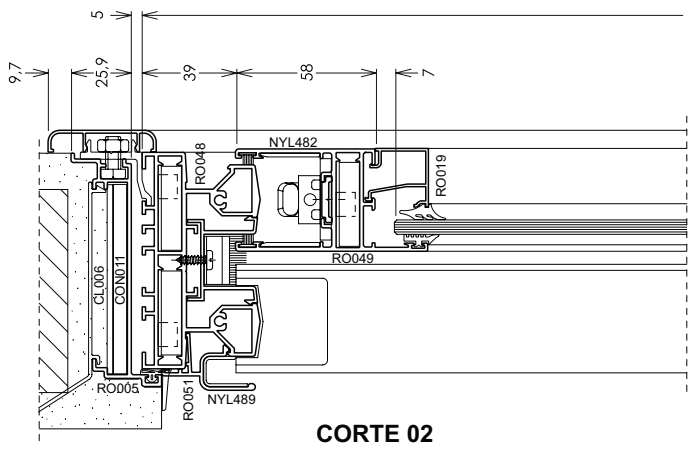
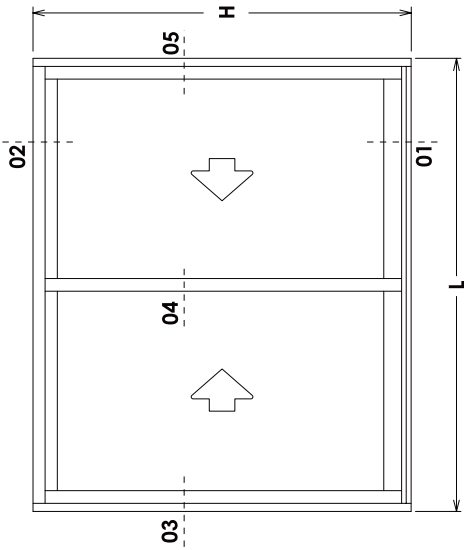

CORTE 02

LADO EXTERNO

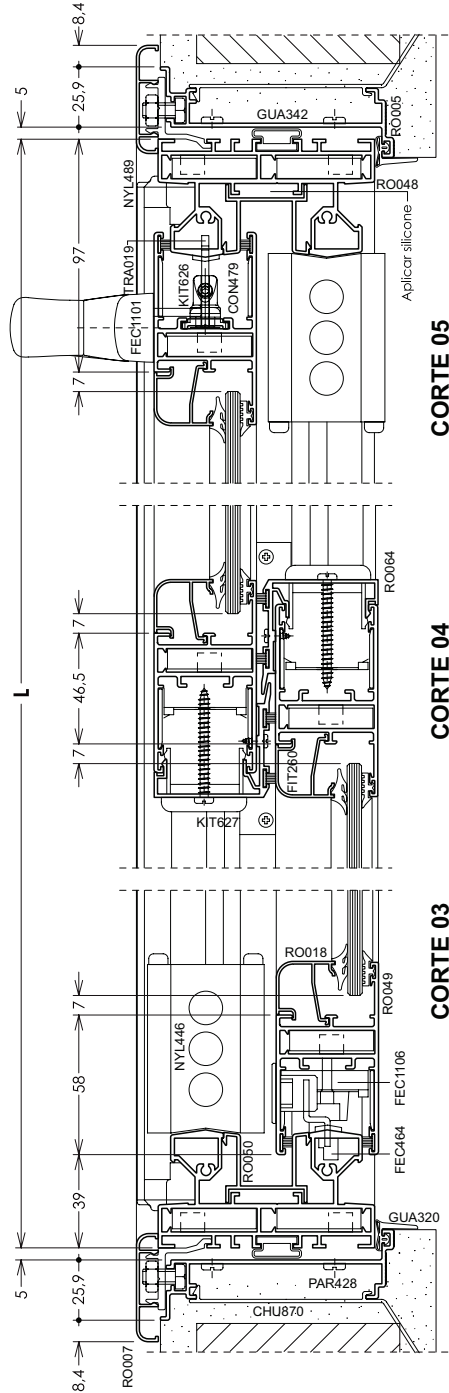

CORTE 05

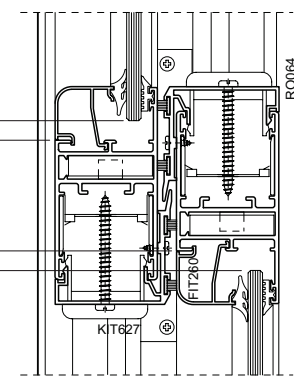

CORTE 04

LADO EXTERNO

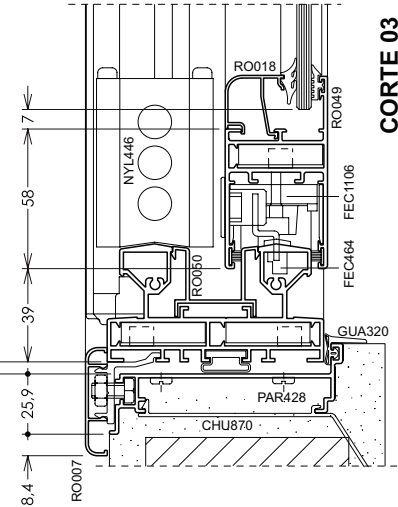

CORTE 03

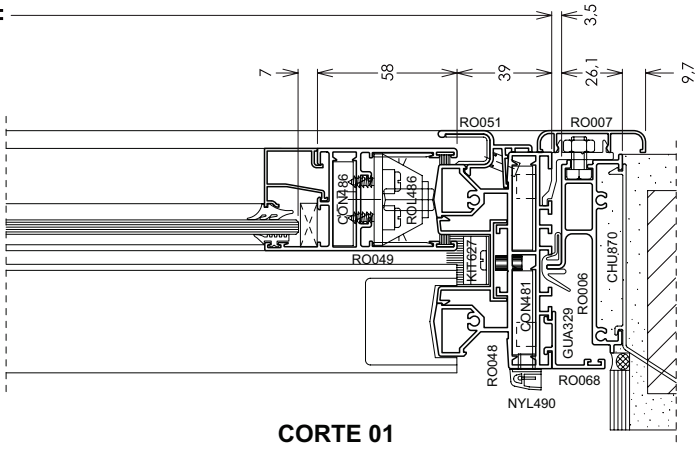

CORTE 01

Janela De Correr 2 Folhas

ELEVAÇÃO VISTA EXTERNA

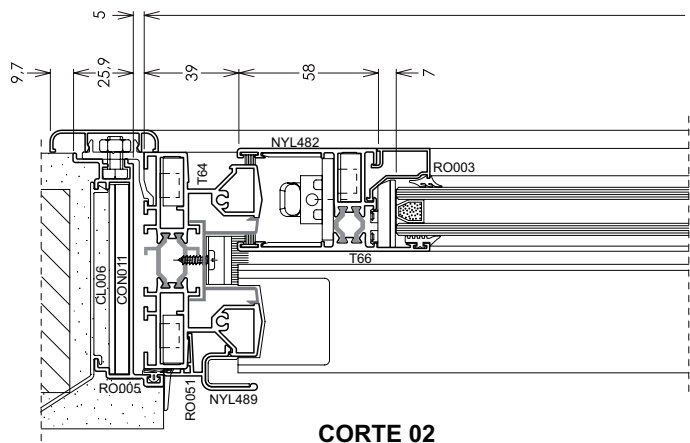
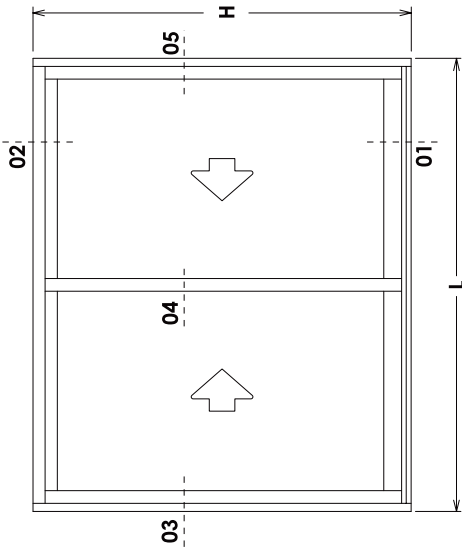

CORTE 02

LADO EXTERNO

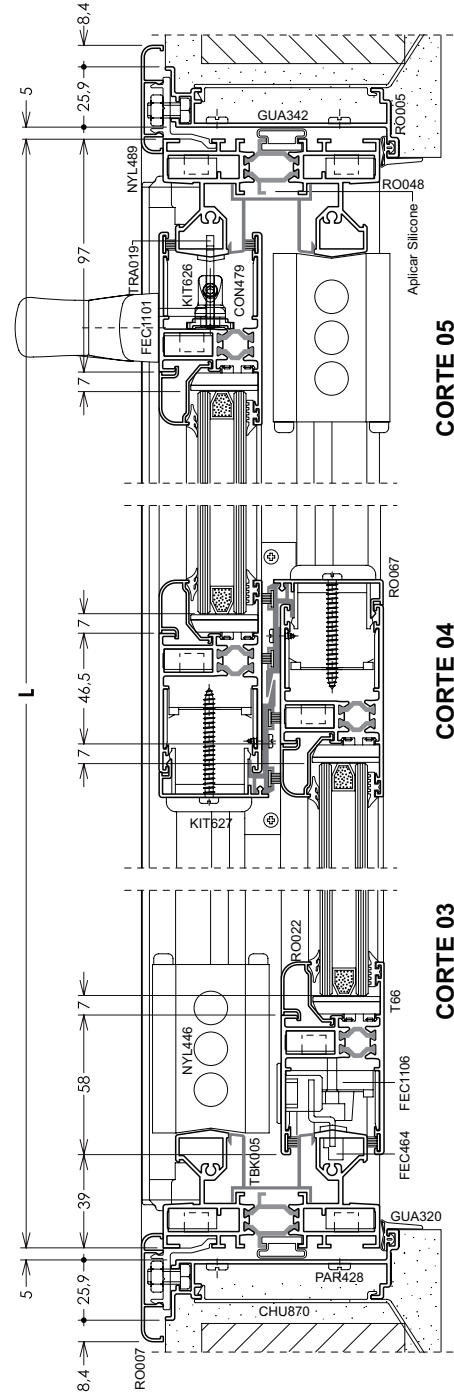

CORTE 05

CORTE 04

CORTE 03

LADO EXTERNO

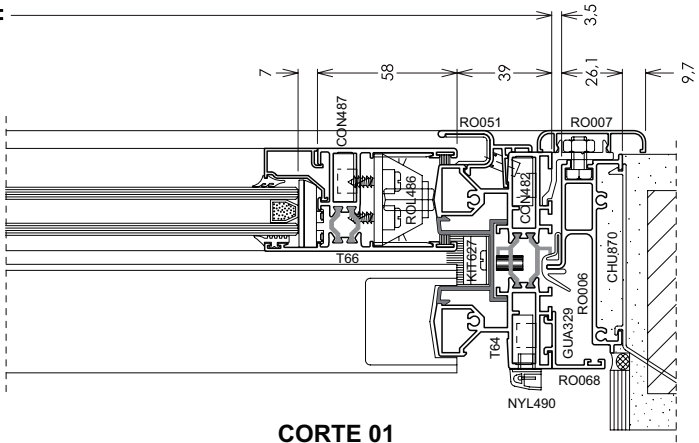

CORTE 01

Janela De Correr 2 Folhas - Multiponto Thermal Break

ELEVAÇÃO VISTA EXTERNA

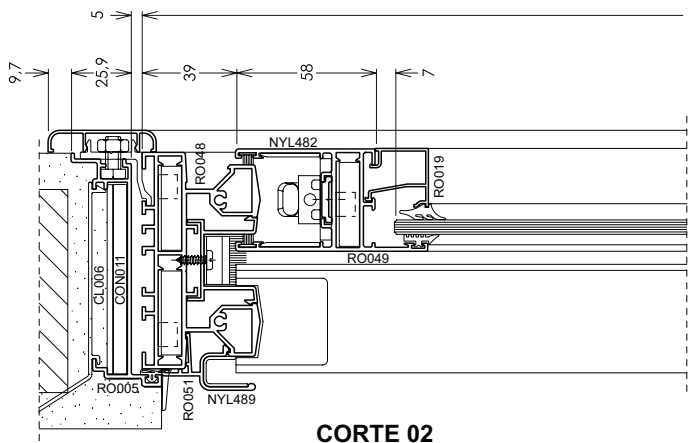
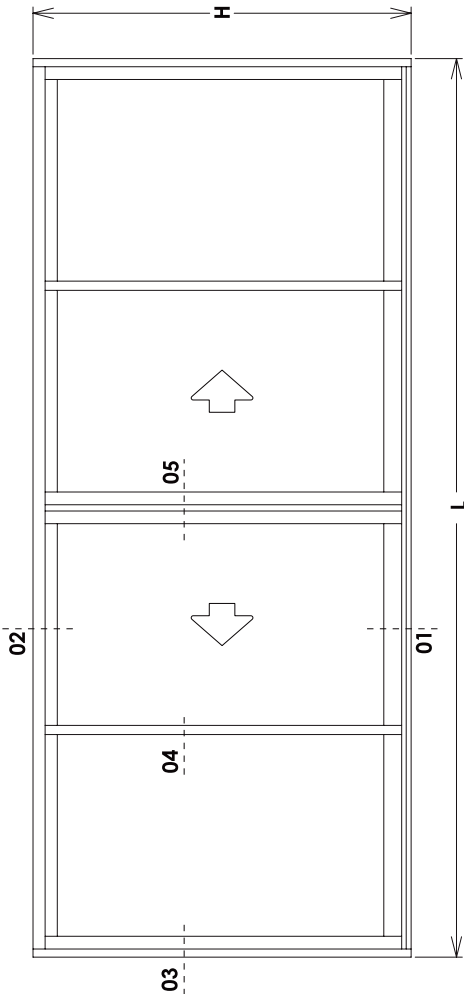

CORTE 02

LADO EXTERNO

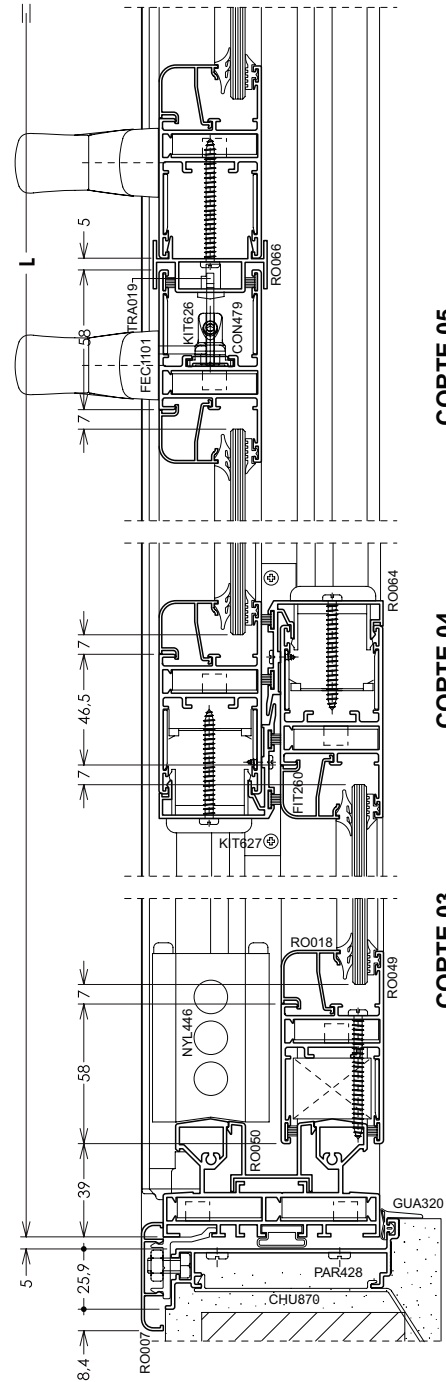

CORTE 03

CORTE 04

CORTE 05

LADO EXTERNO

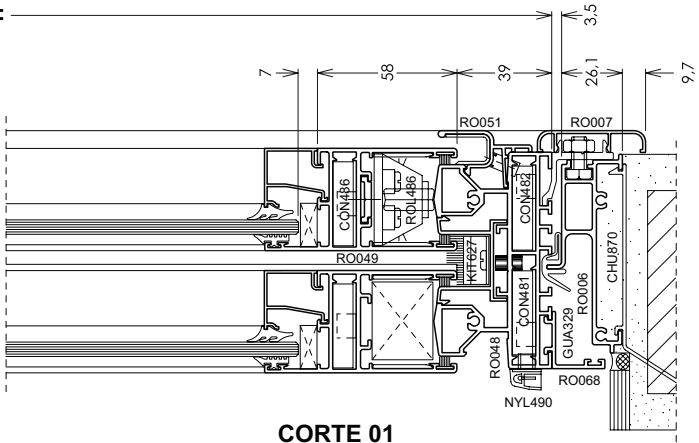

CORTE 01

Janela De Correr 4 Folhas - Multiponto

ELEVAÇÃO VISTA EXTERNA

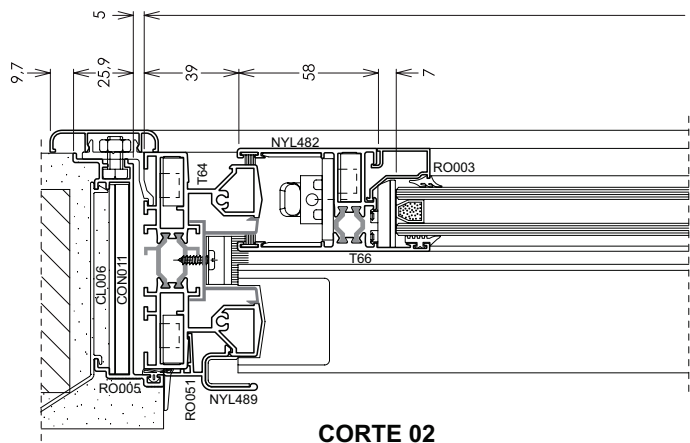
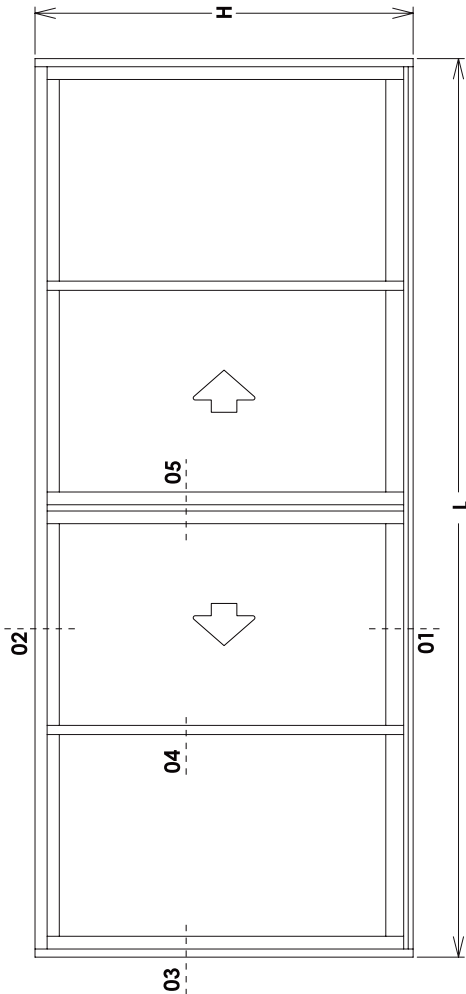

CORTE 02

LADO EXTERNO

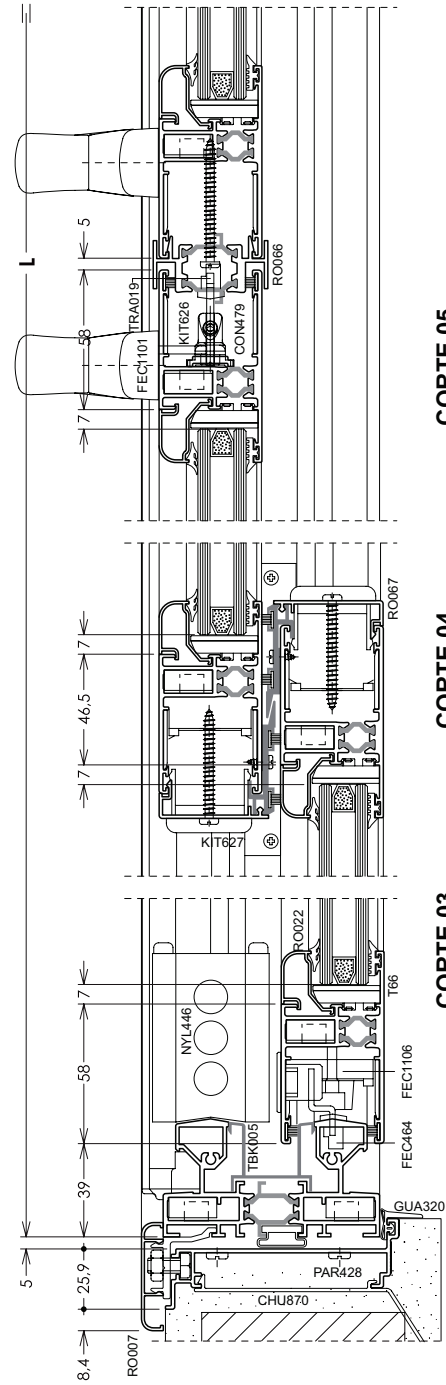

CORTE 03

CORTE 04

CORTE 05

LADO EXTERNO

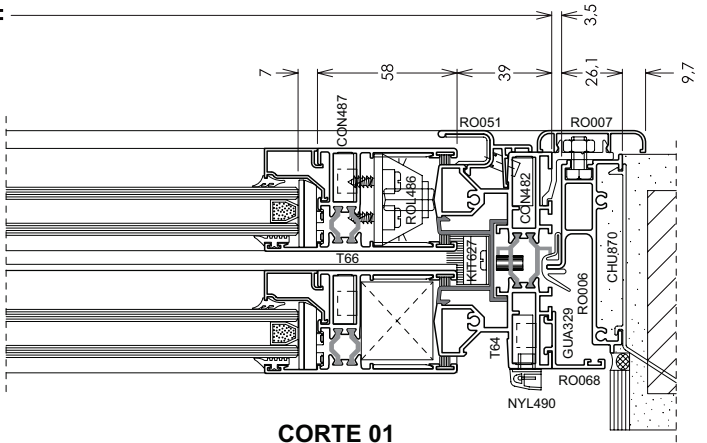

CORTE 01

Janela De Correr 4 Folhas - Multiponto Thermal Break

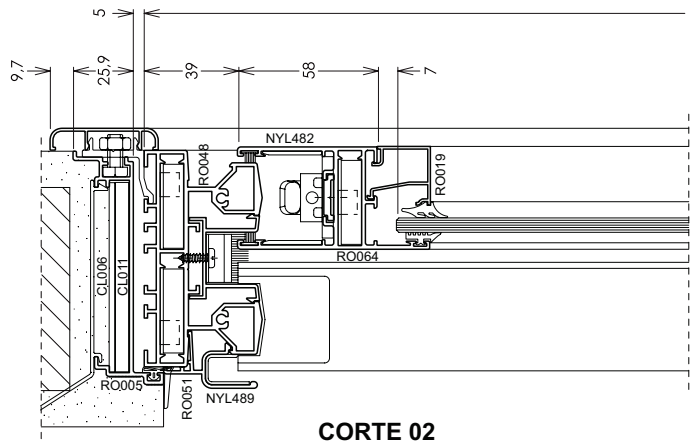
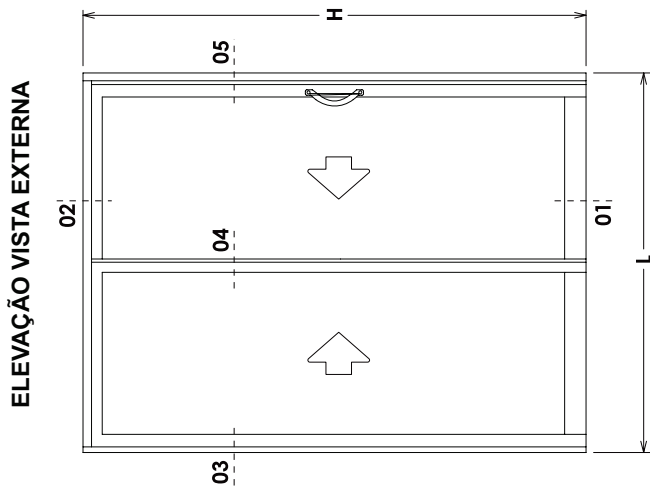

LADO EXTERNO

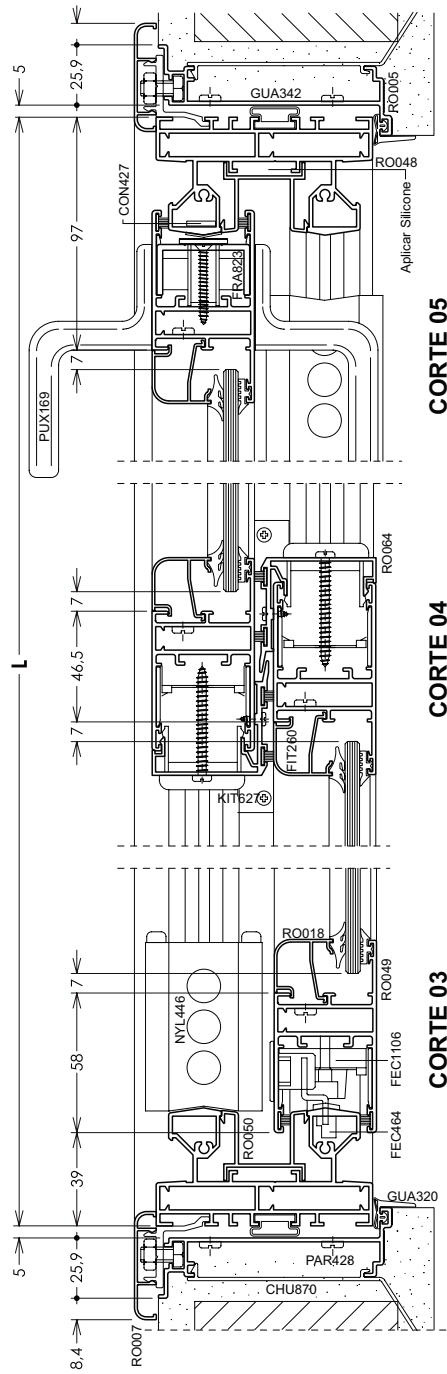

CORTE 05

CORTE 04

CORTE 03

LADO EXTERNO

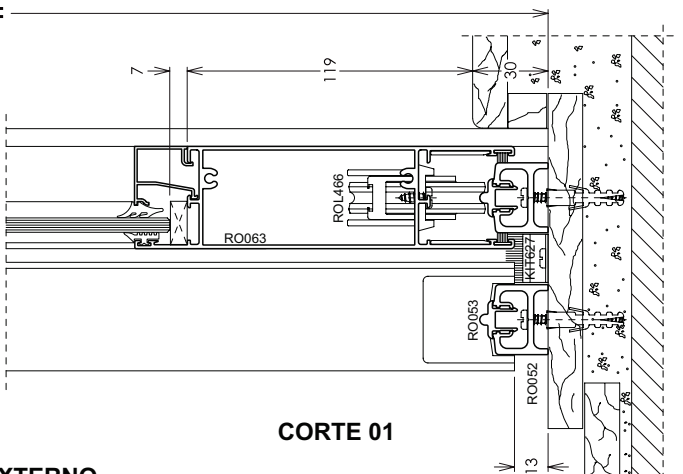

Porta De Correr 2 Folhas Com Fechadura e Puxador

ELEVAÇÃO VISTA EXTERNA

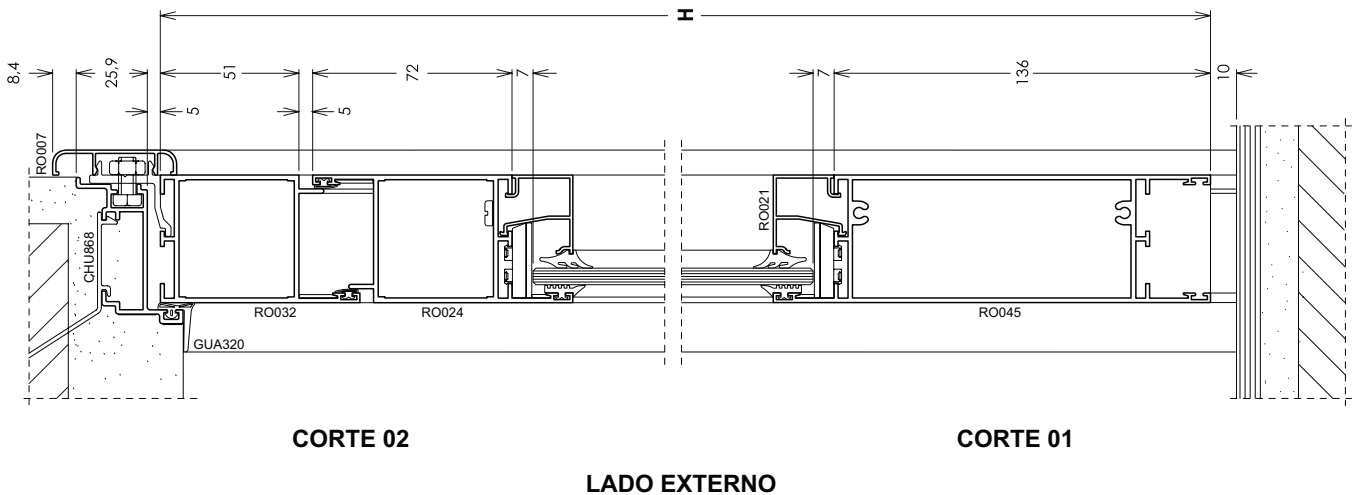
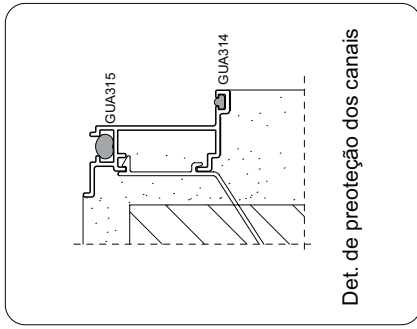
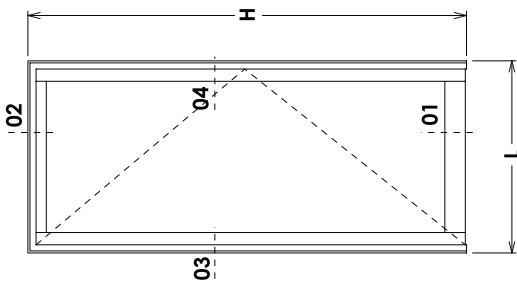

CORTE 02

LADO EXTERNO

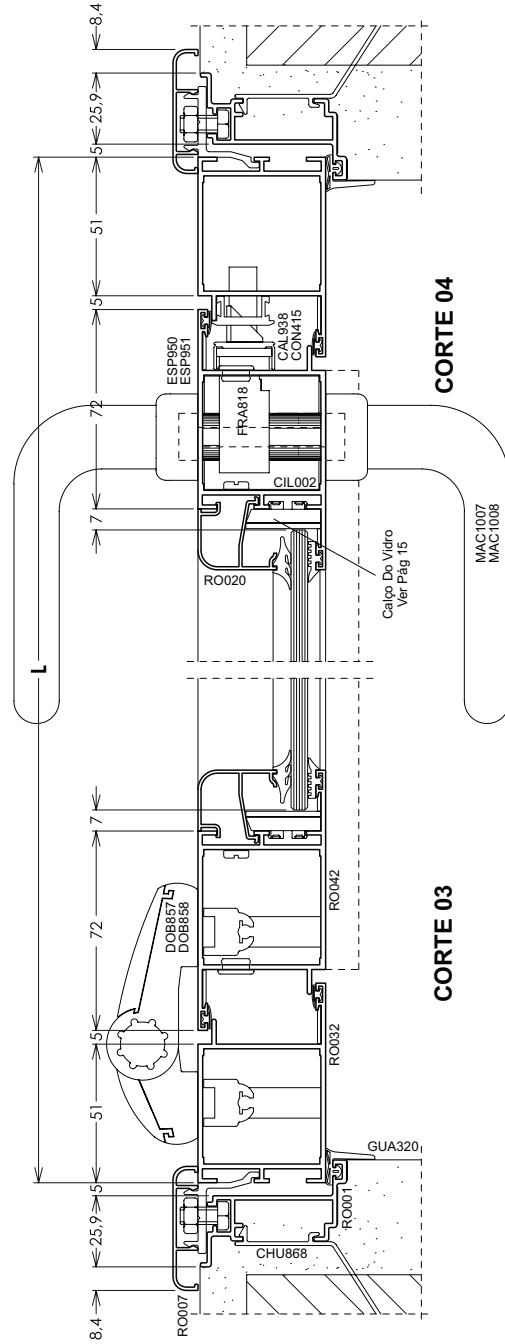

CORTE 03

LADO EXTERNO

Porta De Giro 1 Folha - 40S

ELEVÇÃO VISTA EXTERNA

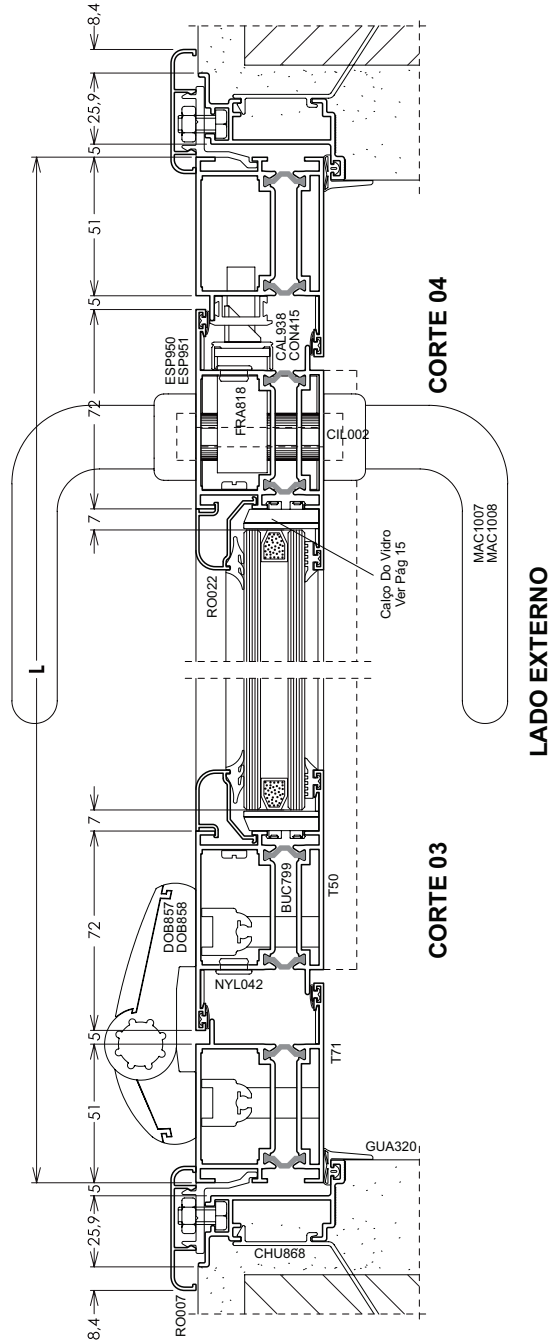
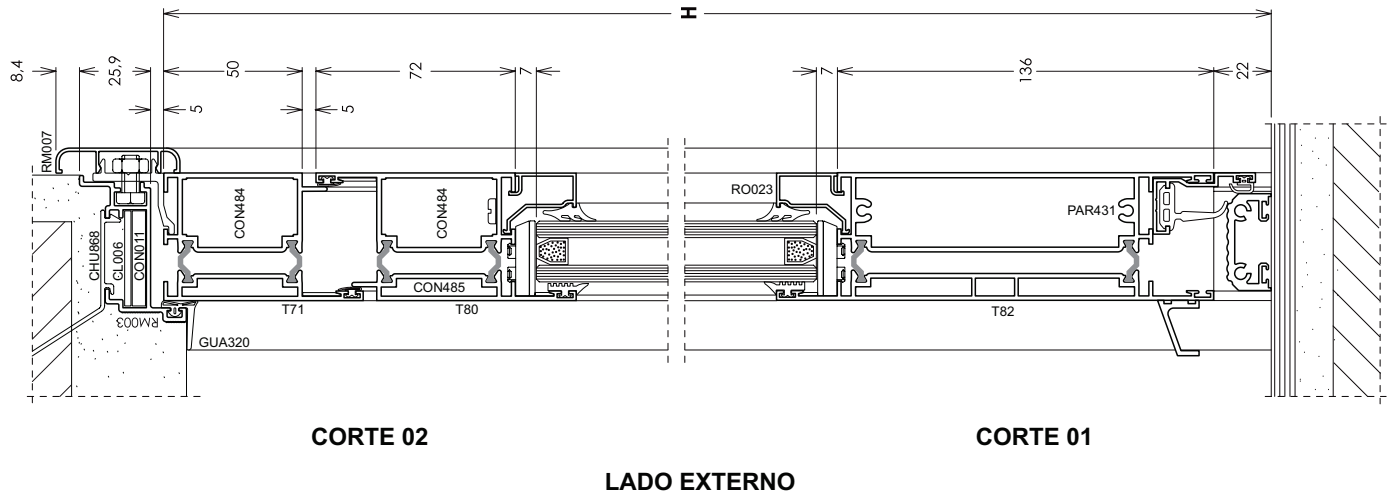
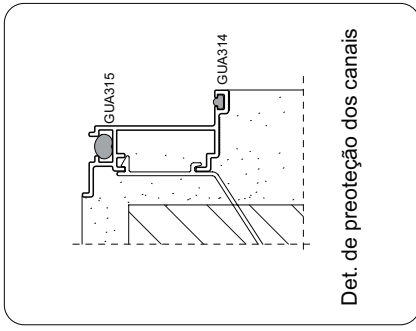
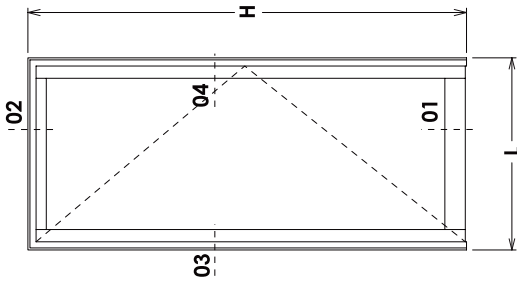

Porta De Giro 1 Folha - 40TT Thermal Break

ELEVAÇÃO VISTA EXTERNA

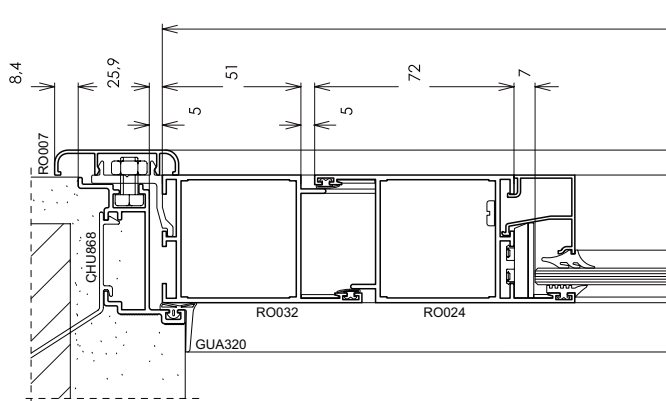
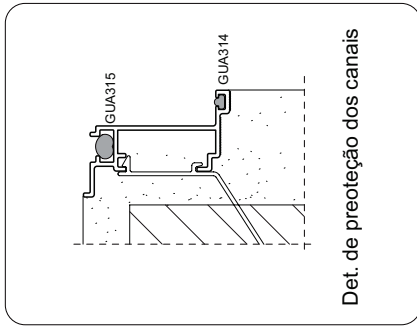
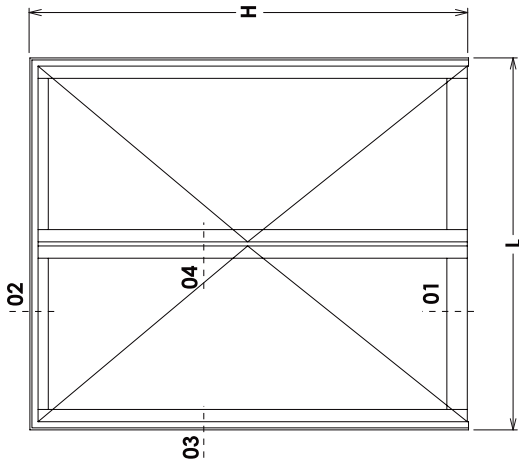

CORTE 02

LADO EXTERNO

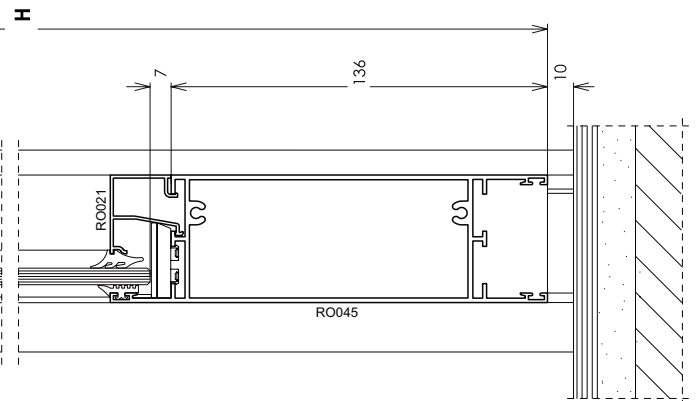

CORTE 01

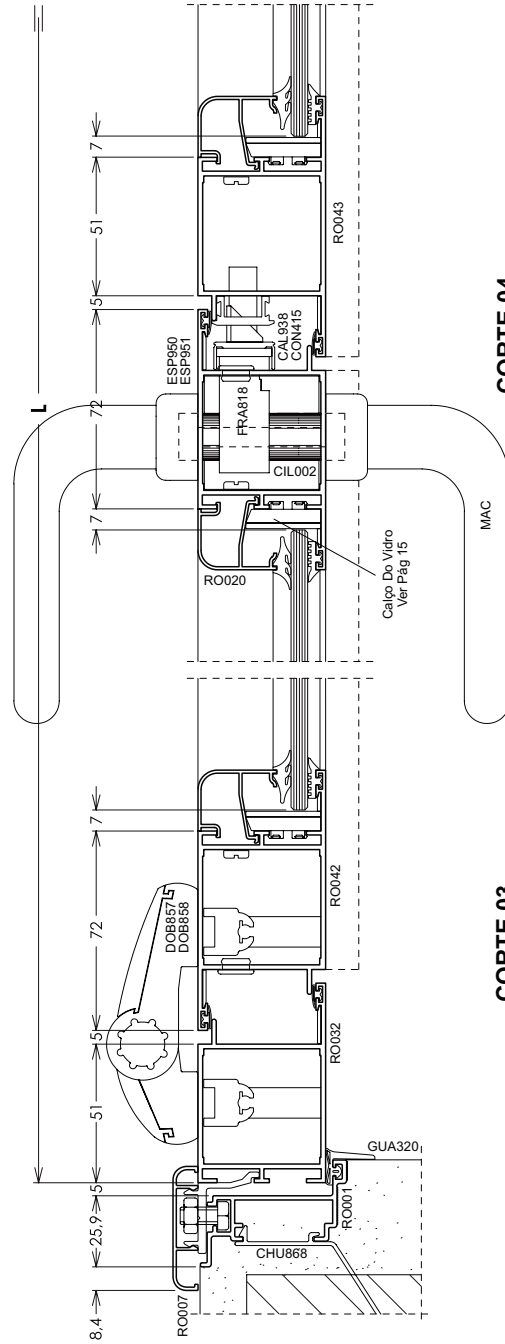

CORTE 03

CORTE 04

LADO EXTERNO

Porta De Giro 2 Folhas - 40S

ELEVAÇÃO VISTA EXTERNA

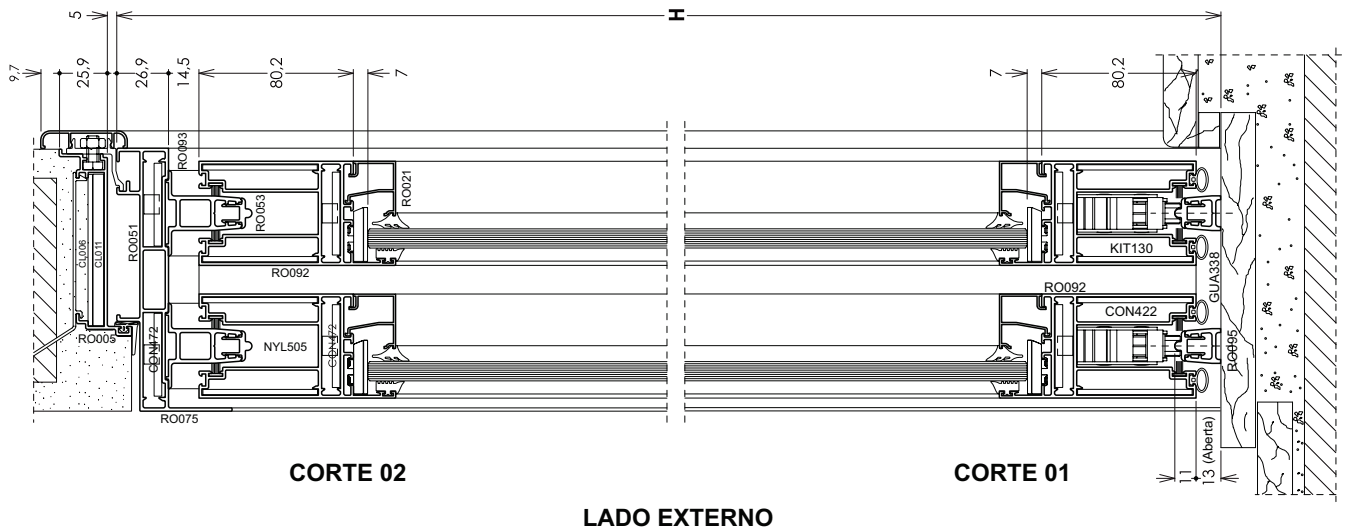
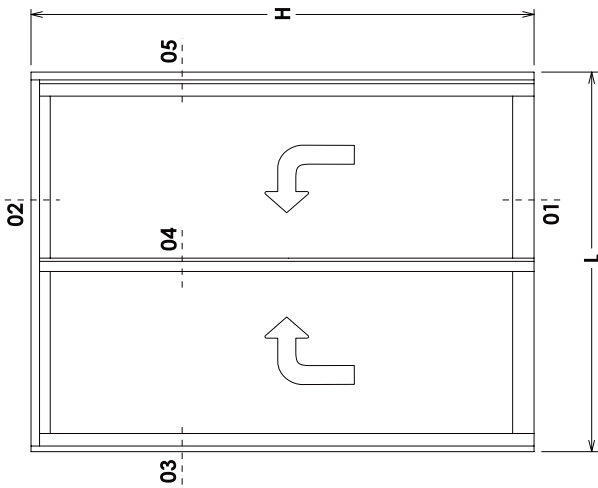

CORTE 02

CORTE 01

LADO EXTERNO

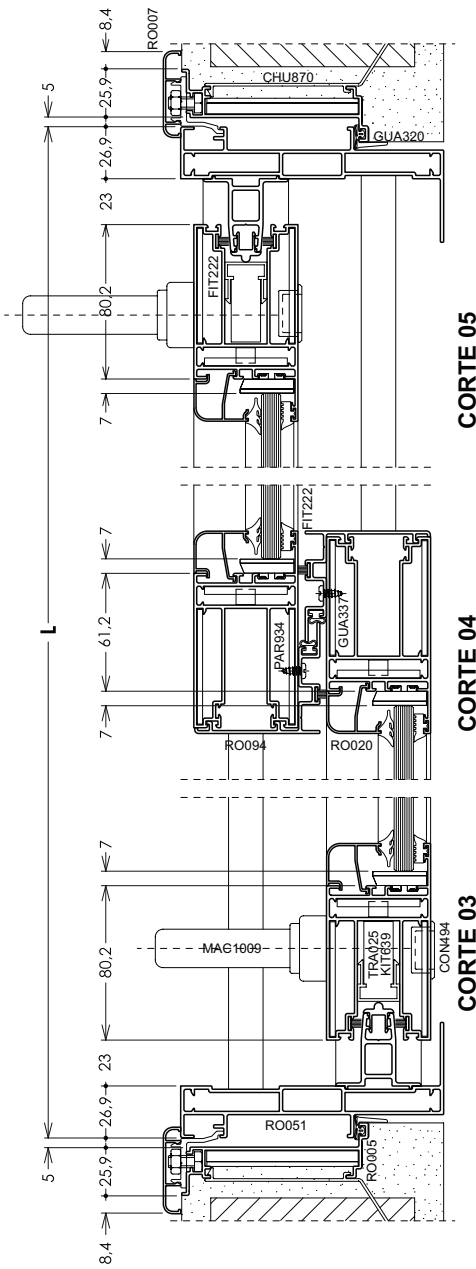

ELEVAÇÃO VISTA EXTERNA

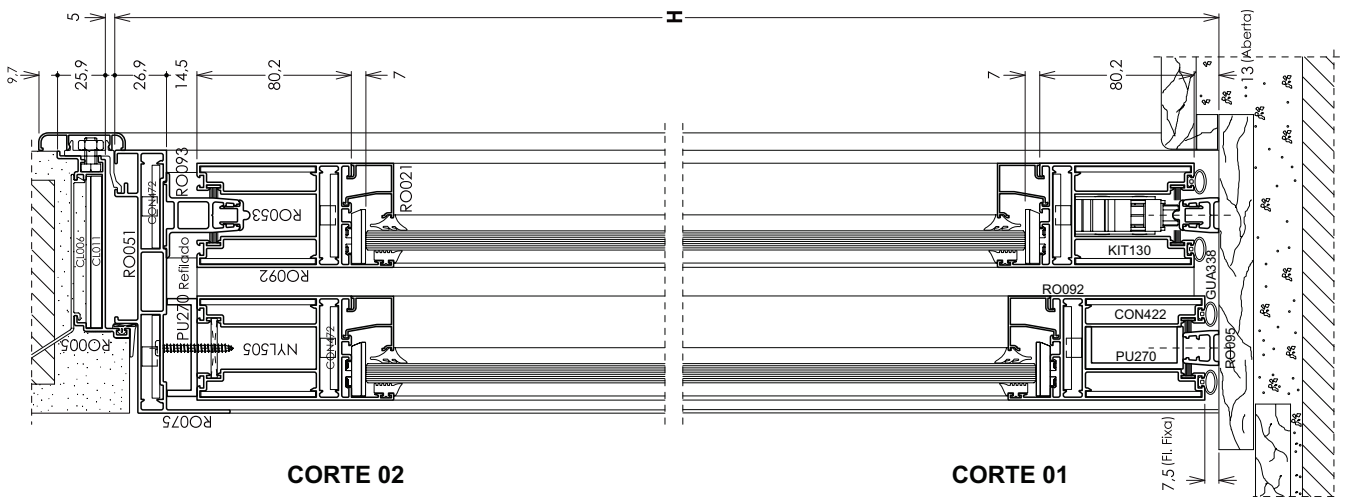
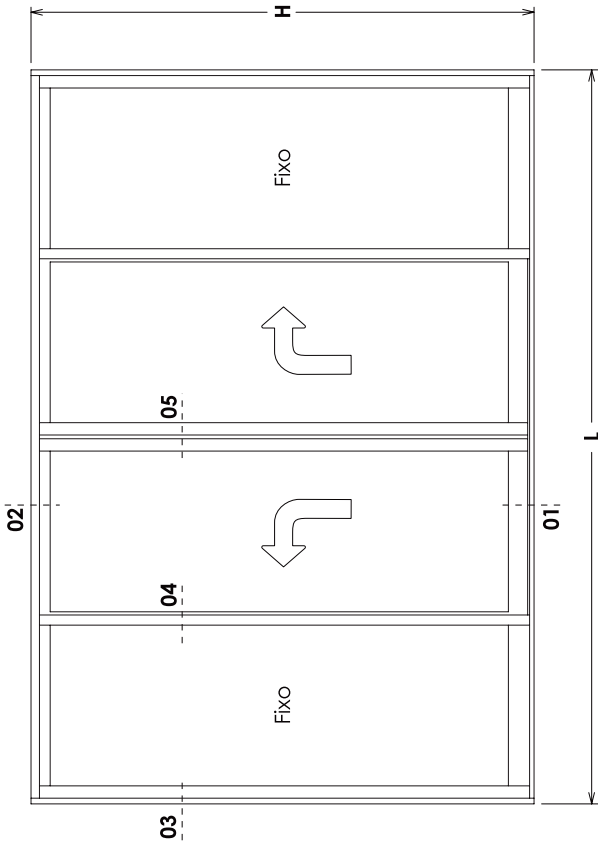

CORTE 02

CORTE 01

LADO EXTERNO

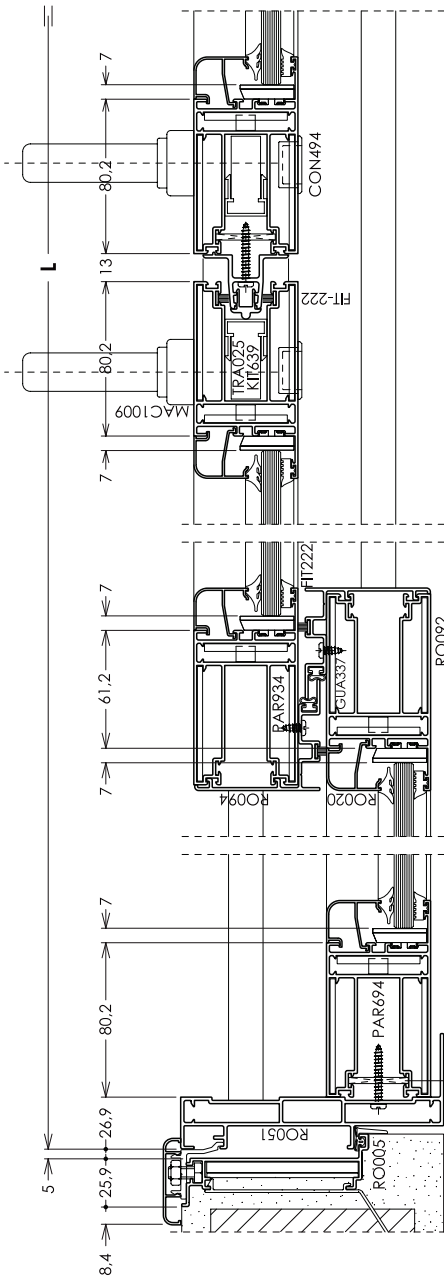

CORTE 03

CORTE 04

CORTE 05

LADO EXTERNO

Porta Elevável 4 Folhas

ELEVAÇÃO VISTA EXTERNA

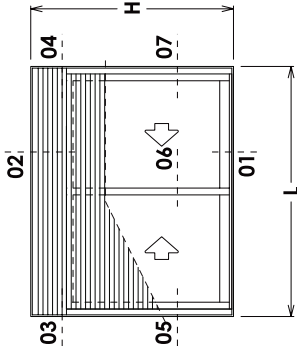

Espuma de Poliuretano
Auto Adesiva com 448 Kg/m³
V2100, da Norfon

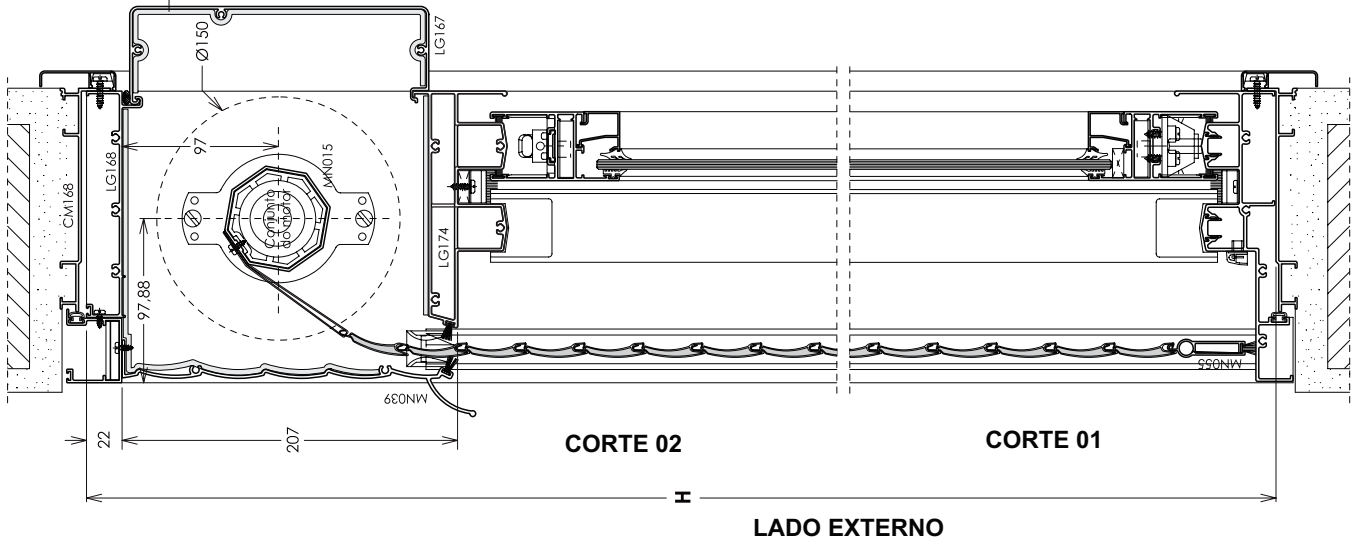

Janela De Correr 2 Folhas Com Persiana Integrada

ELEVAÇÃO VISTA EXTERNA

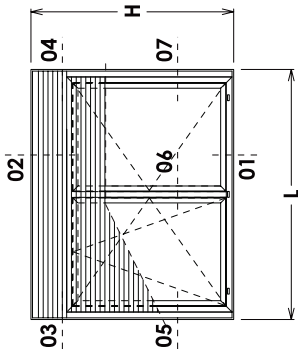

Espuma de Poliuretano Auto Adesiva com 448 Kg/m³ V2100, da Norton

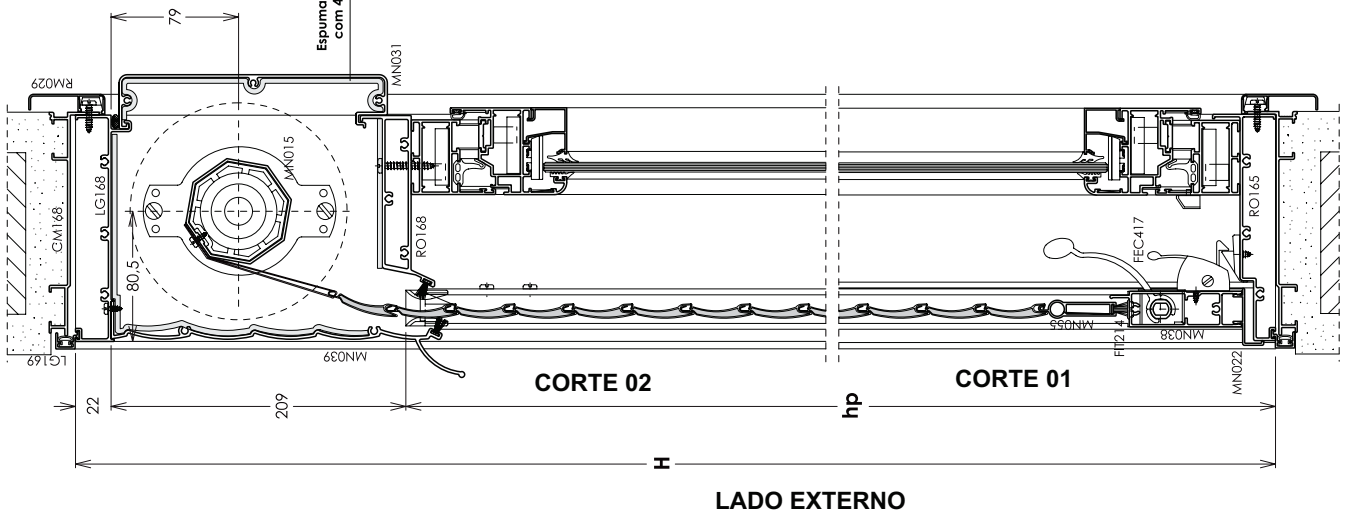

Janela Oscilo Batente 2 Folhas Com Persiana Integrada Projetante

ELEVAÇÃO VISTA EXTERNA

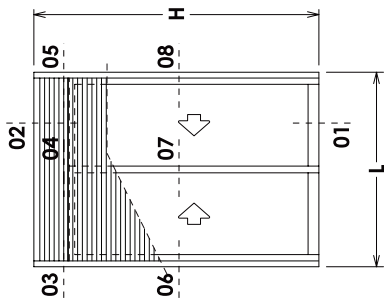

Esponja de Poliuretano
Auto Adesiva com 448 Kg/m³
V2100, da Noron

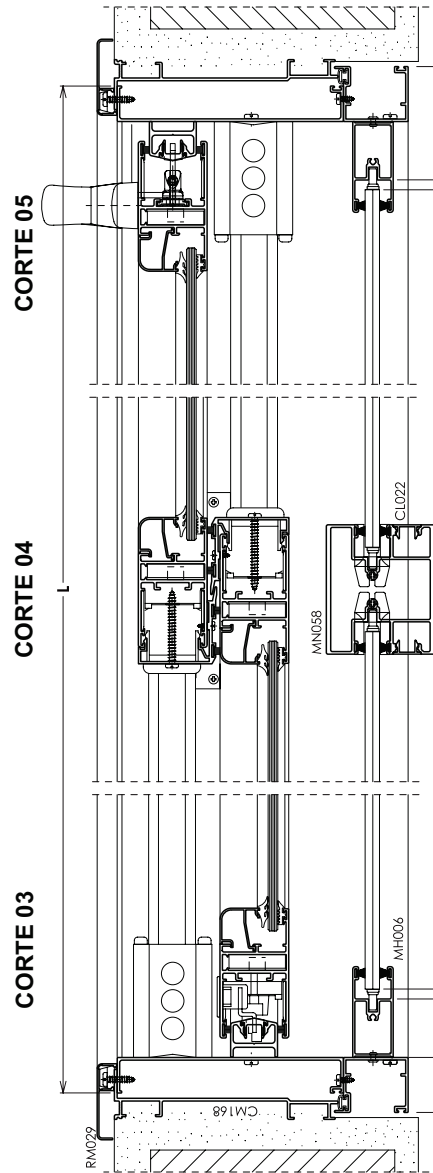
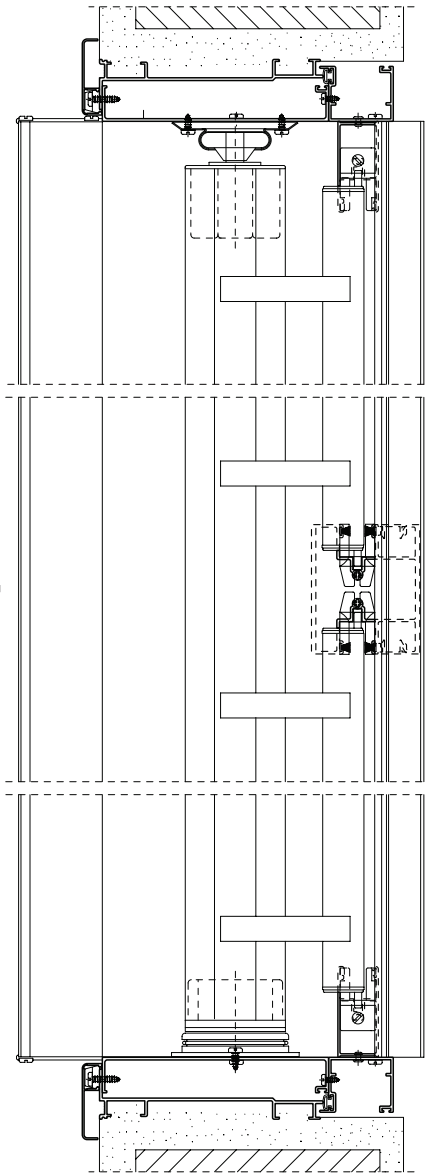
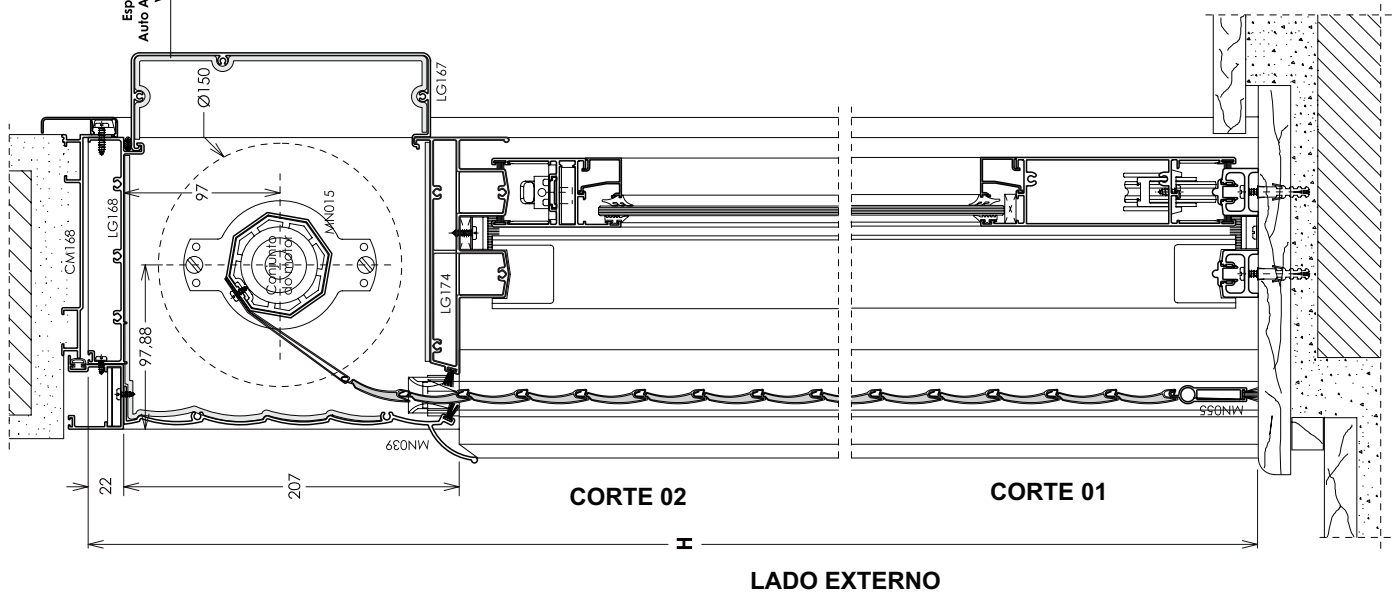

Porta De Correr 2 Folhas Com Persiana Integrada



Catálogo ÚNICA®
Edição 02
www.hydro.com



Hydro